

Instrumentation Tools

Totally Integrated Automation Portal		
--------------------------------------	--	--

PID_PWM and PID_Output

Project							
Name:	PID_PWM and PID_Output	Creation time:	8/7/2023 8:57:33 AM	Last change	8/19/2023 1:01:44 PM	Author:	Mmuhamed
Last modified by:	Mmuhamed	Version:					
Comment:							

Operating system	
Name	Description
Operating system	Microsoft Windows 10 Pro
Version of the operating system	6.3.9600.0
Operating system service pack	
Version of the Internet Explorer	11.789.19041.0
Computer name	MMUHAMED-D1
User name	GULSANEGYPT\Mmuhamed
Installation path of the TIA Portal	C:\Program Files\Siemens\Automation\Portal V16

Components		
Name	Version	Release
TIA Portal Project Server V16 - TIA Portal Project Server Single SetupPackage V16.0 (MUSERVERV16)	V16.0	V16.00.00.00_31.02.00.01
Siemens Totally Integrated Automation Portal V16 - SIMATIC S7-PLCSIM V16.0 (S7_PLCSIM_V16)	V16.0	V16.00.00.00_31.00.13.01
TIA Administrator - AWB Licensing Module V1.0 + SP2 (TIAADMIN)	V1.0 + SP2	V01.00.02.00_01.10.00.01
TIA Administrator - AWB Software Management V1.0 + SP2 (TIAADMIN)	V1.0 + SP2	V01.00.02.00_01.10.00.01
TIA Administrator - TIA UMC Agent Configurator Module V1.0 + SP2 (TIAADMIN)	V1.0 + SP2	V01.00.02.00_01.10.00.01
TIA Administrator - TIA Administrator V1.0 SP2 (TIAADMIN)	V1.0 + SP2	V01.00.02.00_01.10.00.01
Siemens Totally Integrated Automation Portal V16 - HM All Editions Single SetupPackage V16.0 (TIAP16)	V16.0	V16.00.00.00_31.02.00.01
Siemens Totally Integrated Automation Portal V16 - HM NoBasic Single SetupPackage V16.0 (TIAP16)	V16.0	V16.00.00.00_31.02.00.01
Siemens Totally Integrated Automation Portal V16 - Hardware Support Base Package 0 V16.0 (TIAP16)	V16.0	V16.00.00.00_27.01.00.01
Siemens Totally Integrated Automation Portal V16 - Multiuser Client Single SetupPackage V16.0 (TIAP16)	V16.0	V16.00.00.00_31.02.00.01
Siemens Totally Integrated Automation Portal V16 - Version Control Interface SetupPackage V16.0 (TIAP16)	V16.0	V16.00.00.00_31.02.00.01
Siemens Totally Integrated Automation Portal V16 - STEP 7 Safety Single SetupPackage V16.0 (TIAP16)	V16.0	V16.00.00.00_31.02.00.01
Siemens Totally Integrated Automation Portal V16 - SINAMICS Startdrive G110M, G120, G120C, G120D, G120P V16.0 (TIAP16)	V16.0	V16.00.00.00_20.00.00.04
Siemens Totally Integrated Automation Portal V16 - Startdrive Hardware Support Base Package 1 V16.0 (TIAP16)	V16.0	V16.00.00.00_20.00.00.04
Siemens Totally Integrated Automation Portal V16 - SINAMICS-STARTDRIVE-COMMON V16.0 (TIAP16)	V16.0	V16.00.00.00_20.00.00.04
Siemens Totally Integrated Automation Portal V16 - SINAMICS-STARTDRIVE-COMMON-OPENNESS V16.0 (TIAP16)	V16.0	V16.00.00.00_20.00.00.04
Siemens Totally Integrated Automation Portal V16 - SINAMICS-STARTDRIVE-COMMON-SAT V16.0 (TIAP16)	V16.0	V16.00.00.00_20.00.00.04
Siemens Totally Integrated Automation Portal V16 - SINAMICS Startdrive G130, G150, S120, S150, SINAMICS MV V16.0 (TIAP16)	V16.0	V16.00.00.00_20.00.00.04
Siemens Totally Integrated Automation Portal V16 - STEP 7 Single SetupPackage V16.0 (TIAP16)	V16.0	V16.00.00.00_31.02.00.01
Siemens Totally Integrated Automation Portal V16 - Hardware Support Base Package 02 V16.0 (TIAP16)	V16.0	V16.00.00.00_27.01.00.01
Siemens Totally Integrated Automation Portal V16 - Hardware Support Base Package 03 V16.0 (TIAP16)	V16.0	V16.00.00.00_27.01.00.01
Siemens Totally Integrated Automation Portal V16 - Hardware Support Base Package 04 V16.0 (TIAP16)	V16.0	V16.00.00.00_27.01.00.01
Siemens Totally Integrated Automation Portal V16 - Support Base Package TO-01 V16.0 (TIAP16)	V16.0	V16.00.00.00_27.01.00.01
Siemens Totally Integrated Automation Portal V16 - Support Base Package TO-02 V16.0 (TIAP16)	V16.0	V16.00.00.00_27.01.00.01
Siemens Totally Integrated Automation Portal V16 - Hardware Support Base Package WCF-01 V16.0 (TIAP16)	V16.0	V16.00.00.00_27.01.00.01
Siemens Totally Integrated Automation Portal V16 - TIACOMPCKE Single SetupPackage V16.0 (TIAP16)	V16.0	V16.00.00.00_31.02.00.01
Siemens Totally Integrated Automation Portal V16 - Simatic Single SetupPackage V16.0 (TIAP16)	V16.0	V16.00.00.00_31.02.00.01
Siemens Totally Integrated Automation Portal V16 - WinCC Single SetupPackage V16.0 (TIAP16)	V16.0	V16.00.00.00_31.02.00.01
Siemens Totally Integrated Automation Portal V16 - Openness SetupPackage V16.0 (TIAP16)	V16.0	V16.00.00.00_31.02.00.01
Siemens Totally Integrated Automation Portal V16 - WinCC Transfer Mandatory Single SetupPackage V16.0 (TIAP16)	V16.0	V16.00.00.00_31.02.00.01
User Management Component - UserManagementComponentx64 V2.7 (UMC64)	V2.7	V02.07.00.00_04.06.00.07
WinCC Runtime Advanced V16.0 - HMIRTM Tagging Package 01 Single SetupPackage V16.0 (HMIRTM_V11)	V16.0	V16.00.00.00_31.02.00.01
WinCC Runtime Professional V16 - SIMATIC WinCC Runtime V16.0 (SCADA-RT_V11)	V16.0	V07.05.56.00_01.43.00.01
WinCC Runtime Professional V16 - OPCUA_Client V1.1 + SP1 (SCADA-RT_V11)	V1.1 + SP1	V01.01.01.00_01.11.00.01
WinCC Runtime Professional V16 - SCADA Simulation Single SetupPackage V16.0 (SCADA-RT_V11)	V16.0	V16.00.00.00_31.02.00.01
Siemens Totally Integrated Automation Portal V16 - Simatic Single SetupPackage 32 Bit V16.0 (TIAP16)	V16.0	V16.00.00.00_31.02.00.01

Instrumentation Tools

Totally Integrated Automation Portal			
Name			
Siemens Totally Integrated Automation Portal V16 - WinCC Single Setup-Package 32 Bit V16.0 (TIAP16)		V16.0	V16.00.00.00_31.02.00.01
SIMATIC HMI License Manager Panel Plugin (x64)		16.0.0.0	V16.00.00.00_31.02.00.01
SIMATIC WinCC Runtime Advanced Driver (x64)		16.0.0.0	V16.00.00.00_31.02.00.01
ETWEventCollector		16.0.0.0	V16.00.00.00_31.02.00.01
SIMATIC NCM FWL 64		5.6.0.3	K5.6.0.3_1.1.0.2
NCM GPRS 64		01.02.00.00	V1.2.0.0_2.1.0.1
SIMATIC PLCSIM 64		16.00.00	16.00.00.00_01.00.02.01
SIMATIC Device Drivers		9.2	09.02.04.00_01.04.00.05
TelemetryConnector		1.0.2.57	V01.00.02.57_01.00.00.01
Automation Software Updater		02.05.0300	V02.05.03.00_01.01.00.29
SIMATIC HMIProvider		7.0	K07.00.03.01_01.01.00.01
SIEMENS OPC		3.9	03.09.10.00_01.04.00.08
SIMATIC HMI ProSave		16.0.0.0	V16.00.00.00_31.02.00.01
SIMATIC HMI Symbol Library		16.0.0.0	V16.00.00.00_31.02.00.01
SIMATIC HMI Touch Input		16.0.0.0	V16.00.00.00_31.02.00.01
SIMATIC Runtime Interfaces		2.1	K02.01.00.03_01.01.00.01
SIMATIC Device Drivers WoW		29.2	29.02.04.00_01.04.00.05
SIMATIC Event Database		5.6	05.06.02.00_01.01.00.01
SeCon		2.6	V02.06.01.00_01.08.00.01
SIMATIC Station Observer		K7.3.1.0	V07.03.01.00_01.01.00.14
SIMATIC SCS		K7.5.2.2	V07.05.02.02_01.03.00.04
SIMATIC WinCC Common Archiving		V7.5.0.0	V07.05.56.00_01.43.00.01
WinCC Runtime Advanced Simulator		16.0.0.0	V16.00.00.00_31.02.00.01
Products			
Name		Version	Release
TIA Portal Project Server		V16.0	V16.00.00.00_31.02.00.01
SIMATIC S7-PLCSIM		V16.0	V16.00.00.00_31.00.13.01
TIA Administrator		V1.0	01.00.02.00_01.10.00.01
SINAMICS G110M, G120, G120C, G120D, G120P		V16.0	V16.00.00.00_20.00.00.04
SINAMICS G130, G150, S120, S150, SINAMICS MV, S210		V16.0	V16.00.00.00_20.00.00.04
SIMATIC STEP 7 Prof - STEP 7 Safety - WinCC Prof		V16.0	V16.00.00.00_31.02.00.01
User Management Component		V2.7	V02.07.00.00_00.00.00.00
SIMATIC WinCC Runtime Advanced Simulation		V16.0	V16.00.00.00_31.02.00.01
SIMATIC WinCC Runtime Professional Simulation		V16.0	V16.00.00.00_31.02.00.01
Automation License Manager		V6.0 + SP5 + Upd1	06.00.05.01_02.01.00.05
S7-PLCSIM		V5.4 + SP8	V05.04.08.01_01.24.00.01
SIMATIC ProSave		V16.0	V16.00.00.00_31.02.00.01
S7-PCT		V3.5 + SP1	K3.5.1.0_1.19.0.1

Instrumentation Tools

Totally Integrated Automation Portal					
<h2 style="margin: 0;">PID_PWM and PID_Output</h2> <h3 style="margin: 0;">PLC_1 [CPU 1512C-1 PN]</h3>					
PLC_1					
General\Project information					
Name	PLC_1	Author	Mmuhamed	Comment	
Rack	0	Slot	1		
General\Catalog information					
Short designation	CPU 1512C-1 PN	Description	CPU with display; work memory 250 KB code and 1 MB data; 48 ns bit operation time; 4-stage protection concept, technology functions: motion control, closed-loop control, counting and measuring; tracing; Runtime options; for all PROFINET interfaces: transport protocol TCP/IP, secure Open User Communication, S7 communication, S7 routing, IP forwarding, Web server, DNS client, OPC UA: Server DA, Client DA, methods, companion specifications; PROFINET IO controller, supports RT/IRT, performance upgrade PROFINET V2.3, 2 ports, I-Device, MRP, MRPD, isochronous mode, Routing, runtime options; firmware V2.8 with DI32/DQ32, AI5/AQ2: Digital input module DI16 x DC24V, grouping 16; Digital output module DQ16 x DC24V/0.5A, grouping 16; Analog input module AI4 x U/I, AI 1xRTD, 16-bit, grouping 5; Analog output module AQ2 x U/I, 16-bit, grouping 2; 6 channels for counting and measuring with incremental encoders 24V (up to 100kHz); 4 channels for PTO, pulse width modulation, frequency output (up to 100kHz)	Article number	6ES7 512-1CK01-0AB0
Firmware version	V2.8				
General\Identification & Maintenance					
Plant designation		Location identifier		Installation date	2023-08-07 08:58:52.401
Additional information					
General\Checksums					
Text lists	FA 70 E8 75 1D 5A 8E 29	Software	C8 50 6F BC 2B E7 E9 2B		
PROFINET interface [X1]\General					
Name	PROFINET interface_1	Author	Mmuhamed	Comment	
PROFINET interface [X1]\Ethernet addresses\Interface networked with					
Subnet:	PN/IE_1				
PROFINET interface [X1]\Ethernet addresses\IP protocol					
IP configuration	Set IP address in the project	IP address:	192.168.0.1	Subnet mask:	255.255.255.0
Use router	False				
PROFINET interface [X1]\Ethernet addresses\PROFINET					
PROFINET device name is set directly at the device	False	Generate PROFINET device name automatically	True	PROFINET device name:	plc_1.profinet interface_1
Converted name:	plcxb1.profinetxinterfacexb1036c	Device number:	0		
PROFINET interface [X1]\Time-of-day synchronization\NTP mode					
Note	Time synchronization for all PROFINET interfaces take place within the settings for time synchronization of the PROFINET interface [X1].	Enable time synchronization via NTP server	False		IP addresses
Server 1	0.0.0.0	Server 2	0.0.0.0	Server 3	0.0.0.0
Server 4	0.0.0.0	Update interval	10s		
PROFINET interface [X1]\Operating mode					
IO controller	True	IO system		Device number	0
IO device	False				
PROFINET interface [X1]\Advanced options\Interface options					
Call the user program if communication errors occur	False	Support device replacement without exchangeable medium	True	Permit overwriting of device names of all assigned IO devices	False
Limit data infeed into the network	True	Use IEC V2.2 LLDP mode	False	Keep-Alive connection monitoring:	30s
PROFINET interface [X1]\Advanced options\Media redundancy					
MRP domain	mrpdomain-1	Media redundancy role:	Not device in the ring		
PROFINET interface [X1]\Advanced options\Real time settings\IO communication					
Send clock:	1.000ms				
PROFINET interface [X1]\Advanced options\Real time settings\Synchronization					
Sync domain:	Sync-Domain_1	Synchronization role:	Unsynchronized	RT class:	RT,IRT
PROFINET interface [X1]\Advanced options\Real time settings\Real time options					
Calculated bandwidth for cyclic IO data:	0.000ms	Calculated bandwidth for cyclic IO data:	0.000%		
PROFINET interface [X1]\Advanced options\Port [X1 P1 R]\General					
Name	Port_1	Author	Mmuhamed	Comment	
PROFINET interface [X1]\Advanced options\Port [X1 P1 R]\Port interconnection\Local port:					
Local port:	PLC_1\PROFINET interface_1 [X1]\Port_1 [X1 P1 R]	Medium:	Copper	Cable name:	---

Instrumentation Tools

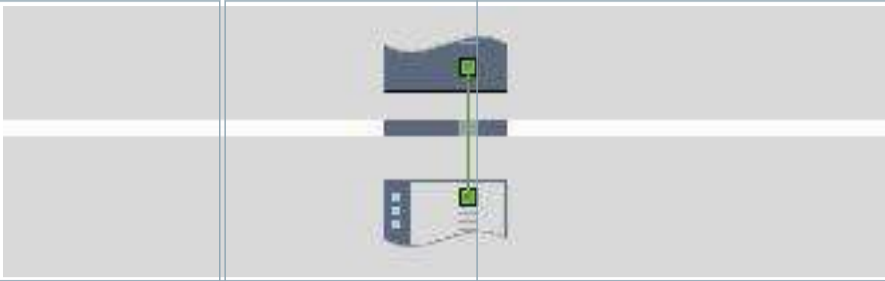
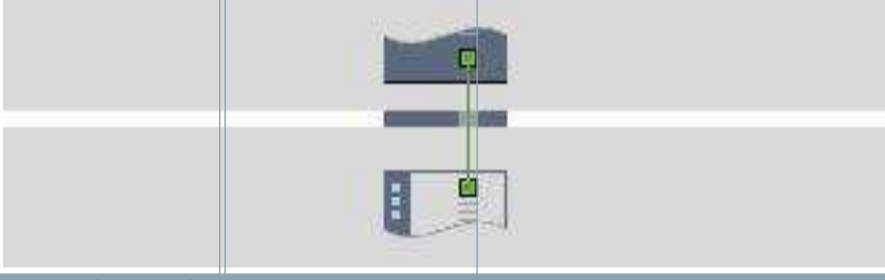
Totally Integrated Automation Portal					
					
PROFINET interface [X1]\Advanced options\Port [X1 P1 R]\Port interconnection\Partner port:					
	Monitoring of partner port is not possible	Alternative partners	False	Partner port:	Any partner
PROFINET interface [X1]\Advanced options\Port [X1 P1 R]\Port options\Activate					
Activate this port for use	True				
PROFINET interface [X1]\Advanced options\Port [X1 P1 R]\Port options\Connection					
Transmission rate / duplex:	Automatic	Monitor	False	Enable autonegotiation	True
PROFINET interface [X1]\Advanced options\Port [X1 P1 R]\Port options\Boundaries					
End of detection of accessible devices	False	End of topology discovery	False	End of the sync domain	False
PROFINET interface [X1]\Advanced options\Port [X1 P2 R]\General					
Name	Port_2	Author	Mmuhamed	Comment	
PROFINET interface [X1]\Advanced options\Port [X1 P2 R]\Port interconnection\Local port:					
Local port:	PLC_1\PROFINET interface_1 [X1]\Port_2 [X1 P2 R]	Medium:	Copper	Cable name:	---
					
PROFINET interface [X1]\Advanced options\Port [X1 P2 R]\Port interconnection\Partner port:					
	Monitoring of partner port is not possible	Alternative partners	False	Partner port:	Any partner
PROFINET interface [X1]\Advanced options\Port [X1 P2 R]\Port options\Activate					
Activate this port for use	True				
PROFINET interface [X1]\Advanced options\Port [X1 P2 R]\Port options\Connection					
Transmission rate / duplex:	Automatic	Monitor	False	Enable autonegotiation	True
PROFINET interface [X1]\Advanced options\Port [X1 P2 R]\Port options\Boundaries					
End of detection of accessible devices	False	End of topology discovery	False	End of the sync domain	False
PROFINET interface [X1]\Web server access					
Note	The Web server must also be activated in the properties of the PLC.		Enable Web server via IP address of this interface	False	
AI 5/AQ 2 [X10]\General					
Name	AI 5/AQ 2_1	Comment			
AI 5/AQ 2 [X10]\Channel template\Inputs\Apply to all channels that use the template\Diagnostics					
Overflow	False	Underflow	False	Wire break	False
Current limit for wire break diagnostics					
AI 5/AQ 2 [X10]\Channel template\Inputs\Apply to all channels that use the template\Measuring					
Measurement type	Voltage	Measuring range	+/- 10V	Temperature coefficient	
Temperature unit	Smoothing		None		
AI 5/AQ 2 [X10]\Channel template\Outputs\Apply to all channels that use the template\Diagnostics					
Wire break	False	Short circuit to ground	False	Overflow	False
Underflow	False				
AI 5/AQ 2 [X10]\Channel template\Outputs\Apply to all channels that use the template\Output parameters					
Output type	Voltage	Output range	+/- 10V	Reaction to CPU STOP	Shutdown
Substitute value					
AI 5/AQ 2 [X10]\AI/AQ configuration\Value status (Quality Information)					
Value status	False				
AI 5/AQ 2 [X10]\Inputs\General\Measuring					
Interference frequency suppression	50Hz				
AI 5/AQ 2 [X10]\Inputs\Channel 0					
Parameter settings	Manual				
AI 5/AQ 2 [X10]\Inputs\Channel 0\Diagnostics					
Overflow	False	Underflow	False	Wire break	False
Current limit for wire break diagnostics					
AI 5/AQ 2 [X10]\Inputs\Channel 0\Measuring					
Measurement type	Voltage	Measuring range	+/- 10V	Temperature coefficient	
Temperature unit	Smoothing		None		
AI 5/AQ 2 [X10]\Inputs\Channel 0\Hardware interrupts					
High limit 1	Low limit 1		High limit 2		
Low limit 2					
AI 5/AQ 2 [X10]\Inputs\Channel 0\Hardware interrupts\					
Hardware interrupt high limit 1	0	RidPrefixFallingEdgeEvent	49272	Event name:	

Instrumentation Tools

Totally Integrated Automation Portal					
Hardware interrupt:	0	UpperLimitOne0	UpperLimitOne0	Channel number	0
HwEventTypeLimit1Overrun	4				
AI 5/AQ 2 [X10]\Inputs\Channel 0\Hardware interrupts\					
Hardware interrupt low limit 1	0	RidPrefixFallingEdgeEvent	49288	Event name:	
Hardware interrupt:	0	LowerLimitOne0	LowerLimitOne0	Channel number	0
HwEventTypeLimit1Underrun	3				
AI 5/AQ 2 [X10]\Inputs\Channel 0\Hardware interrupts\					
Hardware interrupt high limit 2	0	RidPrefixFallingEdgeEvent	49264	Event name:	
Hardware interrupt:	0	UpperLimitTwo0	UpperLimitTwo0	Channel number	0
HwEventTypeLimit2Overrun	6				
AI 5/AQ 2 [X10]\Inputs\Channel 0\Hardware interrupts\					
Hardware interrupt low limit 2	0	RidPrefixFallingEdgeEvent	49280	Event name:	
Hardware interrupt:	0	LowerLimitTwo0	LowerLimitTwo0	Channel number	0
HwEventTypeLimit2Underrun	5				
AI 5/AQ 2 [X10]\Inputs\Channel 1					
Parameter settings	Manual				
AI 5/AQ 2 [X10]\Inputs\Channel 1\Diagnostics					
Overflow	False	Underflow	False	Wire break	False
Current limit for wire break diagnostics					
AI 5/AQ 2 [X10]\Inputs\Channel 1\Measuring					
Measurement type	Voltage	Measuring range	+/- 10V	Temperature coefficient	
Temperature unit		Smoothing	None		
AI 5/AQ 2 [X10]\Inputs\Channel 1\Hardware interrupts					
High limit 1		Low limit 1		High limit 2	
Low limit 2					
AI 5/AQ 2 [X10]\Inputs\Channel 1\Hardware interrupts\					
Hardware interrupt high limit 1	0	RidPrefixFallingEdgeEvent	49273	Event name:	
Hardware interrupt:	0	UpperLimitOne1	UpperLimitOne1	Channel number	1
HwEventTypeLimit1Overrun	4				
AI 5/AQ 2 [X10]\Inputs\Channel 1\Hardware interrupts\					
Hardware interrupt low limit 1	0	RidPrefixFallingEdgeEvent	49289	Event name:	
Hardware interrupt:	0	LowerLimitOne1	LowerLimitOne1	Channel number	1
HwEventTypeLimit1Underrun	3				
AI 5/AQ 2 [X10]\Inputs\Channel 1\Hardware interrupts\					
Hardware interrupt high limit 2	0	RidPrefixFallingEdgeEvent	49265	Event name:	
Hardware interrupt:	0	UpperLimitTwo1	UpperLimitTwo1	Channel number	1
HwEventTypeLimit2Overrun	6				
AI 5/AQ 2 [X10]\Inputs\Channel 1\Hardware interrupts\					
Hardware interrupt low limit 2	0	RidPrefixFallingEdgeEvent	49281	Event name:	
Hardware interrupt:	0	LowerLimitTwo1	LowerLimitTwo1	Channel number	1
HwEventTypeLimit2Underrun	5				
AI 5/AQ 2 [X10]\Inputs\Channel 2					
Parameter settings	Manual				
AI 5/AQ 2 [X10]\Inputs\Channel 2\Diagnostics					
Overflow	False	Underflow	False	Wire break	False
Current limit for wire break diagnostics					
AI 5/AQ 2 [X10]\Inputs\Channel 2\Measuring					
Measurement type	Voltage	Measuring range	+/- 10V	Temperature coefficient	
Temperature unit		Smoothing	None		
AI 5/AQ 2 [X10]\Inputs\Channel 2\Hardware interrupts					
High limit 1		Low limit 1		High limit 2	
Low limit 2					
AI 5/AQ 2 [X10]\Inputs\Channel 2\Hardware interrupts\					
Hardware interrupt high limit 1	0	RidPrefixFallingEdgeEvent	49274	Event name:	
Hardware interrupt:	0	UpperLimitOne2	UpperLimitOne2	Channel number	2
HwEventTypeLimit1Overrun	4				
AI 5/AQ 2 [X10]\Inputs\Channel 2\Hardware interrupts\					
Hardware interrupt low limit 1	0	RidPrefixFallingEdgeEvent	49290	Event name:	
Hardware interrupt:	0	LowerLimitOne2	LowerLimitOne2	Channel number	2
HwEventTypeLimit1Underrun	3				
AI 5/AQ 2 [X10]\Inputs\Channel 2\Hardware interrupts\					
Hardware interrupt high limit 2	0	RidPrefixFallingEdgeEvent	49266	Event name:	
Hardware interrupt:	0	UpperLimitTwo2	UpperLimitTwo2	Channel number	2
HwEventTypeLimit2Overrun	6				

Instrumentation Tools

Totally Integrated Automation Portal					
AI 5/AQ 2 [X10]\Inputs\Channel 2\Hardware interrupts\					
Hardware interrupt low limit 2	0	RidPrefixFallingEdgeEvent	49282	Event name:	
Hardware interrupt:	0	LowerLimitTwo2	LowerLimitTwo2	Channel number	2
HwEventTypeLimit2Underrun	5				
AI 5/AQ 2 [X10]\Inputs\Channel 3					
Parameter settings	Manual				
AI 5/AQ 2 [X10]\Inputs\Channel 3\Diagnostics					
Overflow	False	Underflow	False	Wire break	False
Current limit for wire break diagnostics					
AI 5/AQ 2 [X10]\Inputs\Channel 3\Measuring					
Measurement type	Voltage	Measuring range	+/- 10V	Temperature coefficient	
Temperature unit		Smoothing	None		
AI 5/AQ 2 [X10]\Inputs\Channel 3\Hardware interrupts					
High limit 1		Low limit 1		High limit 2	
Low limit 2					
AI 5/AQ 2 [X10]\Inputs\Channel 3\Hardware interrupts\					
Hardware interrupt high limit 1	0	RidPrefixFallingEdgeEvent	49275	Event name:	
Hardware interrupt:	0	UpperLimitOne3	UpperLimitOne3	Channel number	3
HwEventTypeLimit1Overrun	4				
AI 5/AQ 2 [X10]\Inputs\Channel 3\Hardware interrupts\					
Hardware interrupt low limit 1	0	RidPrefixFallingEdgeEvent	49291	Event name:	
Hardware interrupt:	0	LowerLimitOne3	LowerLimitOne3	Channel number	3
HwEventTypeLimit1Underrun	3				
AI 5/AQ 2 [X10]\Inputs\Channel 3\Hardware interrupts\					
Hardware interrupt high limit 2	0	RidPrefixFallingEdgeEvent	49267	Event name:	
Hardware interrupt:	0	UpperLimitTwo3	UpperLimitTwo3	Channel number	3
HwEventTypeLimit2Overrun	6				
AI 5/AQ 2 [X10]\Inputs\Channel 3\Hardware interrupts\					
Hardware interrupt low limit 2	0	RidPrefixFallingEdgeEvent	49283	Event name:	
Hardware interrupt:	0	LowerLimitTwo3	LowerLimitTwo3	Channel number	3
HwEventTypeLimit2Underrun	5				
AI 5/AQ 2 [X10]\Inputs\Channel 4					
Parameter settings	Manual				
AI 5/AQ 2 [X10]\Inputs\Channel 4\Diagnostics					
Overflow	False	Underflow	False	Wire break	False
Current limit for wire break diagnostics					
AI 5/AQ 2 [X10]\Inputs\Channel 4\Measuring					
Measurement type	Resistance	Measuring range	600Ohm	Temperature coefficient	
Temperature unit		Smoothing	None		
AI 5/AQ 2 [X10]\Inputs\Channel 4\Hardware interrupts					
High limit 1		Low limit 1		High limit 2	
Low limit 2					
AI 5/AQ 2 [X10]\Inputs\Channel 4\Hardware interrupts\					
Hardware interrupt high limit 1	0	RidPrefixFallingEdgeEvent	49276	Event name:	
Hardware interrupt:	0	UpperLimitOne4	UpperLimitOne4	Channel number	4
HwEventTypeLimit1Overrun	4				
AI 5/AQ 2 [X10]\Inputs\Channel 4\Hardware interrupts\					
Hardware interrupt low limit 1	0	RidPrefixFallingEdgeEvent	49292	Event name:	
Hardware interrupt:	0	LowerLimitOne4	LowerLimitOne4	Channel number	4
HwEventTypeLimit1Underrun	3				
AI 5/AQ 2 [X10]\Inputs\Channel 4\Hardware interrupts\					
Hardware interrupt high limit 2	0	RidPrefixFallingEdgeEvent	49268	Event name:	
Hardware interrupt:	0	UpperLimitTwo4	UpperLimitTwo4	Channel number	4
HwEventTypeLimit2Overrun	6				
AI 5/AQ 2 [X10]\Inputs\Channel 4\Hardware interrupts\					
Hardware interrupt low limit 2	0	RidPrefixFallingEdgeEvent	49284	Event name:	
Hardware interrupt:	0	LowerLimitTwo4	LowerLimitTwo4	Channel number	4
HwEventTypeLimit2Underrun	5				
AI 5/AQ 2 [X10]\Outputs\Channel 0					
Parameter settings	Manual				
AI 5/AQ 2 [X10]\Outputs\Channel 0\Diagnostics					
Wire break	False	Short circuit to ground	False	Overflow	False
Underflow	False				
AI 5/AQ 2 [X10]\Outputs\Channel 0\Output					
Output type	Voltage	Output range	+/- 10V	Reaction to CPU STOP	Shutdown
Substitute value					

Instrumentation Tools

Totally Integrated Automation Portal					
AI 5/AQ 2 [X10]\Outputs\Channel 1					
Parameter settings	Manual				
AI 5/AQ 2 [X10]\Outputs\Channel 1\Diagnostics					
Wire break	False	Short circuit to ground	False	Overflow	False
Underflow	False				
AI 5/AQ 2 [X10]\Outputs\Channel 1\Output					
Output type	Voltage	Output range	+/- 10V	Reaction to CPU STOP	Shutdown
Substitute value					
AI 5/AQ 2 [X10]\I/O addresses\Input addresses					
Start address	0	End address	9	Organization block	0
Process image	0				
AI 5/AQ 2 [X10]\I/O addresses\Output addresses					
Start address	0	End address	3	Organization block	0
Process image	0				
DI 16/DQ 16 [X11]\General					
Name	DI 16/DQ 16_1	Comment			
DI 16/DQ 16 [X11]\Channel template\Inputs\Apply to all channels that use the template\Diagnostics					
No supply voltage L+	False				
DI 16/DQ 16 [X11]\Channel template\Inputs\Apply to all channels that use the template\Input parameters					
Input delay	3.2ms				
DI 16/DQ 16 [X11]\Channel template\Outputs\Apply to all channels that use the template\Diagnostics					
No supply voltage L+	False				
DI 16/DQ 16 [X11]\Channel template\Outputs\Apply to all channels that use the template\Output parameters					
Reaction to CPU STOP	Shutdown				
DI 16/DQ 16 [X11]\DI/DQ configuration\Value status (Quality Information)					
Value status	False				
DI 16/DQ 16 [X11]\Inputs\Channel 0					
Parameter settings	From template				
DI 16/DQ 16 [X11]\Inputs\Channel 0\Diagnostics					
No supply voltage L+	False				
DI 16/DQ 16 [X11]\Inputs\Channel 0\Input parameters					
Input delay	3.2ms				
DI 16/DQ 16 [X11]\Inputs\Channel 0\Hardware interrupts\					
Enable rising edge detection	0	RidPrefixRisingEdgeEvent	49152	Event name:	
Hardware interrupt:	0	Rising edge0	Rising edge0	Channel number	0
HwEventTypeRisingEdge	1				
DI 16/DQ 16 [X11]\Inputs\Channel 0\Hardware interrupts\					
Enable falling edge detection	0	RidPrefixFallingEdgeEvent	49280	Event name:	
Hardware interrupt:	0	Falling edge0	Falling edge0	Channel number	0
HwEventTypeFallingEdge	2				
DI 16/DQ 16 [X11]\Inputs\Channel 1					
Parameter settings	From template				
DI 16/DQ 16 [X11]\Inputs\Channel 1\Diagnostics					
No supply voltage L+	False				
DI 16/DQ 16 [X11]\Inputs\Channel 1\Input parameters					
Input delay	3.2ms				
DI 16/DQ 16 [X11]\Inputs\Channel 1\Hardware interrupts\					
Enable rising edge detection	0	RidPrefixRisingEdgeEvent	49153	Event name:	
Hardware interrupt:	0	Rising edge1	Rising edge1	Channel number	1
HwEventTypeRisingEdge	1				
DI 16/DQ 16 [X11]\Inputs\Channel 1\Hardware interrupts\					
Enable falling edge detection	0	RidPrefixFallingEdgeEvent	49281	Event name:	
Hardware interrupt:	0	Falling edge1	Falling edge1	Channel number	1
HwEventTypeFallingEdge	2				
DI 16/DQ 16 [X11]\Inputs\Channel 2					
Parameter settings	From template				
DI 16/DQ 16 [X11]\Inputs\Channel 2\Diagnostics					
No supply voltage L+	False				
DI 16/DQ 16 [X11]\Inputs\Channel 2\Input parameters					
Input delay	3.2ms				
DI 16/DQ 16 [X11]\Inputs\Channel 2\Hardware interrupts\					
Enable rising edge detection	0	RidPrefixRisingEdgeEvent	49154	Event name:	
Hardware interrupt:	0	Rising edge2	Rising edge2	Channel number	2
HwEventTypeRisingEdge	1				
DI 16/DQ 16 [X11]\Inputs\Channel 2\Hardware interrupts\					
Enable falling edge detection	0	RidPrefixFallingEdgeEvent	49282	Event name:	
Hardware interrupt:	0	Falling edge2	Falling edge2	Channel number	2
HwEventTypeFallingEdge	2				
DI 16/DQ 16 [X11]\Inputs\Channel 3					
Parameter settings	From template				
DI 16/DQ 16 [X11]\Inputs\Channel 3\Diagnostics					
No supply voltage L+	False				
DI 16/DQ 16 [X11]\Inputs\Channel 3\Input parameters					
Input delay	3.2ms				

Instrumentation Tools

Totally Integrated Automation Portal					
DI 16/DQ 16 [X11]\Inputs\Channel 3\Hardware interrupts\					
Enable rising edge detection	0	RidPrefixRisingEdgeEvent	49155	Event name:	
Hardware interrupt:	0	Rising edge3	Rising edge3	Channel number	3
HwEventTypeRisingEdge	1				
DI 16/DQ 16 [X11]\Inputs\Channel 3\Hardware interrupts\					
Enable falling edge detection	0	RidPrefixFallingEdgeEvent	49283	Event name:	
Hardware interrupt:	0	Falling edge3	Falling edge3	Channel number	3
HwEventTypeFallingEdge	2				
DI 16/DQ 16 [X11]\Inputs\Channel 4					
Parameter settings	From template				
DI 16/DQ 16 [X11]\Inputs\Channel 4\Diagnostics					
No supply voltage L+	False				
DI 16/DQ 16 [X11]\Inputs\Channel 4\Input parameters					
Input delay	3.2ms				
DI 16/DQ 16 [X11]\Inputs\Channel 4\Hardware interrupts\					
Enable rising edge detection	0	RidPrefixRisingEdgeEvent	49156	Event name:	
Hardware interrupt:	0	Rising edge4	Rising edge4	Channel number	4
HwEventTypeRisingEdge	1				
DI 16/DQ 16 [X11]\Inputs\Channel 4\Hardware interrupts\					
Enable falling edge detection	0	RidPrefixFallingEdgeEvent	49284	Event name:	
Hardware interrupt:	0	Falling edge4	Falling edge4	Channel number	4
HwEventTypeFallingEdge	2				
DI 16/DQ 16 [X11]\Inputs\Channel 5					
Parameter settings	From template				
DI 16/DQ 16 [X11]\Inputs\Channel 5\Diagnostics					
No supply voltage L+	False				
DI 16/DQ 16 [X11]\Inputs\Channel 5\Input parameters					
Input delay	3.2ms				
DI 16/DQ 16 [X11]\Inputs\Channel 5\Hardware interrupts\					
Enable rising edge detection	0	RidPrefixRisingEdgeEvent	49157	Event name:	
Hardware interrupt:	0	Rising edge5	Rising edge5	Channel number	5
HwEventTypeRisingEdge	1				
DI 16/DQ 16 [X11]\Inputs\Channel 5\Hardware interrupts\					
Enable falling edge detection	0	RidPrefixFallingEdgeEvent	49285	Event name:	
Hardware interrupt:	0	Falling edge5	Falling edge5	Channel number	5
HwEventTypeFallingEdge	2				
DI 16/DQ 16 [X11]\Inputs\Channel 6					
Parameter settings	From template				
DI 16/DQ 16 [X11]\Inputs\Channel 6\Diagnostics					
No supply voltage L+	False				
DI 16/DQ 16 [X11]\Inputs\Channel 6\Input parameters					
Input delay	3.2ms				
DI 16/DQ 16 [X11]\Inputs\Channel 6\Hardware interrupts\					
Enable rising edge detection	0	RidPrefixRisingEdgeEvent	49158	Event name:	
Hardware interrupt:	0	Rising edge6	Rising edge6	Channel number	6
HwEventTypeRisingEdge	1				
DI 16/DQ 16 [X11]\Inputs\Channel 6\Hardware interrupts\					
Enable falling edge detection	0	RidPrefixFallingEdgeEvent	49286	Event name:	
Hardware interrupt:	0	Falling edge6	Falling edge6	Channel number	6
HwEventTypeFallingEdge	2				
DI 16/DQ 16 [X11]\Inputs\Channel 7					
Parameter settings	From template				
DI 16/DQ 16 [X11]\Inputs\Channel 7\Diagnostics					
No supply voltage L+	False				
DI 16/DQ 16 [X11]\Inputs\Channel 7\Input parameters					
Input delay	3.2ms				
DI 16/DQ 16 [X11]\Inputs\Channel 7\Hardware interrupts\					
Enable rising edge detection	0	RidPrefixRisingEdgeEvent	49159	Event name:	
Hardware interrupt:	0	Rising edge7	Rising edge7	Channel number	7
HwEventTypeRisingEdge	1				
DI 16/DQ 16 [X11]\Inputs\Channel 7\Hardware interrupts\					
Enable falling edge detection	0	RidPrefixFallingEdgeEvent	49287	Event name:	
Hardware interrupt:	0	Falling edge7	Falling edge7	Channel number	7
HwEventTypeFallingEdge	2				
DI 16/DQ 16 [X11]\Inputs\Channel 8					
Parameter settings	From template				
DI 16/DQ 16 [X11]\Inputs\Channel 8\Diagnostics					
No supply voltage L+	False				

Instrumentation Tools

Totally Integrated Automation Portal					
DI 16/DQ 16 [X11]\Inputs\Channel 8\Input parameters					
Input delay	3.2ms				
DI 16/DQ 16 [X11]\Inputs\Channel 8\Hardware interrupts\					
Enable rising edge detection	0	RidPrefixRisingEdgeEvent	49160	Event name:	
Hardware interrupt:	0	Rising edge8	Rising edge8	Channel number	8
HwEventTypeRisingEdge	1				
DI 16/DQ 16 [X11]\Inputs\Channel 8\Hardware interrupts\					
Enable falling edge detection	0	RidPrefixFallingEdgeEvent	49288	Event name:	
Hardware interrupt:	0	Falling edge8	Falling edge8	Channel number	8
HwEventTypeFallingEdge	2				
DI 16/DQ 16 [X11]\Inputs\Channel 9					
Parameter settings	From template				
DI 16/DQ 16 [X11]\Inputs\Channel 9\Diagnostics					
No supply voltage L+	False				
DI 16/DQ 16 [X11]\Inputs\Channel 9\Input parameters					
Input delay	3.2ms				
DI 16/DQ 16 [X11]\Inputs\Channel 9\Hardware interrupts\					
Enable rising edge detection	0	RidPrefixRisingEdgeEvent	49161	Event name:	
Hardware interrupt:	0	Rising edge9	Rising edge9	Channel number	9
HwEventTypeRisingEdge	1				
DI 16/DQ 16 [X11]\Inputs\Channel 9\Hardware interrupts\					
Enable falling edge detection	0	RidPrefixFallingEdgeEvent	49289	Event name:	
Hardware interrupt:	0	Falling edge9	Falling edge9	Channel number	9
HwEventTypeFallingEdge	2				
DI 16/DQ 16 [X11]\Inputs\Channel 10					
Parameter settings	From template				
DI 16/DQ 16 [X11]\Inputs\Channel 10\Diagnostics					
No supply voltage L+	False				
DI 16/DQ 16 [X11]\Inputs\Channel 10\Input parameters					
Input delay	3.2ms				
DI 16/DQ 16 [X11]\Inputs\Channel 10\Hardware interrupts\					
Enable rising edge detection	0	RidPrefixRisingEdgeEvent	49162	Event name:	
Hardware interrupt:	0	Rising edge10	Rising edge10	Channel number	10
HwEventTypeRisingEdge	1				
DI 16/DQ 16 [X11]\Inputs\Channel 10\Hardware interrupts\					
Enable falling edge detection	0	RidPrefixFallingEdgeEvent	49290	Event name:	0
Hardware interrupt:	0	Falling edge10	Falling edge10	Channel number	10
HwEventTypeFallingEdge	2				
DI 16/DQ 16 [X11]\Inputs\Channel 11					
Parameter settings	From template				
DI 16/DQ 16 [X11]\Inputs\Channel 11\Diagnostics					
No supply voltage L+	False				
DI 16/DQ 16 [X11]\Inputs\Channel 11\Input parameters					
Input delay	3.2ms				
DI 16/DQ 16 [X11]\Inputs\Channel 11\Hardware interrupts\					
Enable rising edge detection	0	RidPrefixRisingEdgeEvent	49163	Event name:	
Hardware interrupt:	0	Rising edge11	Rising edge11	Channel number	11
HwEventTypeRisingEdge	1				
DI 16/DQ 16 [X11]\Inputs\Channel 11\Hardware interrupts\					
Enable falling edge detection	0	RidPrefixFallingEdgeEvent	49291	Event name:	
Hardware interrupt:	0	Falling edge11	Falling edge11	Channel number	11
HwEventTypeFallingEdge	2				
DI 16/DQ 16 [X11]\Inputs\Channel 12					
Parameter settings	From template				
DI 16/DQ 16 [X11]\Inputs\Channel 12\Diagnostics					
No supply voltage L+	False				
DI 16/DQ 16 [X11]\Inputs\Channel 12\Input parameters					
Input delay	3.2ms				
DI 16/DQ 16 [X11]\Inputs\Channel 12\Hardware interrupts\					
Enable rising edge detection	0	RidPrefixRisingEdgeEvent	49164	Event name:	
Hardware interrupt:	0	Rising edge12	Rising edge12	Channel number	12
HwEventTypeRisingEdge	1				
DI 16/DQ 16 [X11]\Inputs\Channel 12\Hardware interrupts\					
Enable falling edge detection	0	RidPrefixFallingEdgeEvent	49292	Event name:	
Hardware interrupt:	0	Falling edge12	Falling edge12	Channel number	12
HwEventTypeFallingEdge	2				
DI 16/DQ 16 [X11]\Inputs\Channel 13					
Parameter settings	From template				

Instrumentation Tools

Totally Integrated Automation Portal		
DI 16/DQ 16 [X11]\Inputs\Channel 13\Diagnostics		
No supply voltage L+	False	
DI 16/DQ 16 [X11]\Inputs\Channel 13\Input parameters		
Input delay	3.2ms	
DI 16/DQ 16 [X11]\Inputs\Channel 13\Hardware interrupts		
Enable rising edge detection	0	RidPrefixRisingEdgeEvent 49165
Hardware interrupt:	0	Rising edge13 Rising edge13
HwEventTypeRisingEdge	1	Event name: Channel number 13
DI 16/DQ 16 [X11]\Inputs\Channel 13\Hardware interrupts		
Enable falling edge detection	0	RidPrefixFallingEdgeEvent 49293
Hardware interrupt:	0	Falling edge13 Falling edge13
HwEventTypeFallingEdge	2	Event name: Channel number 13
DI 16/DQ 16 [X11]\Inputs\Channel 14		
Parameter settings	From template	
DI 16/DQ 16 [X11]\Inputs\Channel 14\Diagnostics		
No supply voltage L+	False	
DI 16/DQ 16 [X11]\Inputs\Channel 14\Input parameters		
Input delay	3.2ms	
DI 16/DQ 16 [X11]\Inputs\Channel 14\Hardware interrupts		
Enable rising edge detection	0	RidPrefixRisingEdgeEvent 49166
Hardware interrupt:	0	Rising edge14 Rising edge14
HwEventTypeRisingEdge	1	Event name: Channel number 14
DI 16/DQ 16 [X11]\Inputs\Channel 14\Hardware interrupts		
Enable falling edge detection	0	RidPrefixFallingEdgeEvent 49294
Hardware interrupt:	0	Falling edge14 Falling edge14
HwEventTypeFallingEdge	2	Event name: Channel number 14
DI 16/DQ 16 [X11]\Inputs\Channel 15		
Parameter settings	From template	
DI 16/DQ 16 [X11]\Inputs\Channel 15\Diagnostics		
No supply voltage L+	False	
DI 16/DQ 16 [X11]\Inputs\Channel 15\Input parameters		
Input delay	3.2ms	
DI 16/DQ 16 [X11]\Inputs\Channel 15\Hardware interrupts		
Enable rising edge detection	0	RidPrefixRisingEdgeEvent 49167
Hardware interrupt:	0	Rising edge15 Rising edge15
HwEventTypeRisingEdge	1	Event name: Channel number 15
DI 16/DQ 16 [X11]\Inputs\Channel 15\Hardware interrupts		
Enable falling edge detection	0	RidPrefixFallingEdgeEvent 49295
Hardware interrupt:	0	Falling edge15 Falling edge15
HwEventTypeFallingEdge	2	Event name: Channel number 15
DI 16/DQ 16 [X11]\Outputs\Channel 0		
Parameter settings	From template	
DI 16/DQ 16 [X11]\Outputs\Channel 0\Diagnostics		
No supply voltage L+	False	
DI 16/DQ 16 [X11]\Outputs\Channel 0\Output parameters		
Reaction to CPU STOP	Shutdown	
DI 16/DQ 16 [X11]\Outputs\Channel 1		
Parameter settings	From template	
DI 16/DQ 16 [X11]\Outputs\Channel 1\Diagnostics		
No supply voltage L+	False	
DI 16/DQ 16 [X11]\Outputs\Channel 1\Output parameters		
Reaction to CPU STOP	Shutdown	
DI 16/DQ 16 [X11]\Outputs\Channel 2		
Parameter settings	From template	
DI 16/DQ 16 [X11]\Outputs\Channel 2\Diagnostics		
No supply voltage L+	False	
DI 16/DQ 16 [X11]\Outputs\Channel 2\Output parameters		
Reaction to CPU STOP	Shutdown	
DI 16/DQ 16 [X11]\Outputs\Channel 3		
Parameter settings	From template	
DI 16/DQ 16 [X11]\Outputs\Channel 3\Diagnostics		
No supply voltage L+	False	
DI 16/DQ 16 [X11]\Outputs\Channel 3\Output parameters		
Reaction to CPU STOP	Shutdown	
DI 16/DQ 16 [X11]\Outputs\Channel 4		
Parameter settings	From template	
DI 16/DQ 16 [X11]\Outputs\Channel 4\Diagnostics		
No supply voltage L+	False	
DI 16/DQ 16 [X11]\Outputs\Channel 4\Output parameters		
Reaction to CPU STOP	Shutdown	
DI 16/DQ 16 [X11]\Outputs\Channel 5		
Parameter settings	From template	
DI 16/DQ 16 [X11]\Outputs\Channel 5\Diagnostics		
No supply voltage L+	False	
DI 16/DQ 16 [X11]\Outputs\Channel 5\Output parameters		
Reaction to CPU STOP	Shutdown	

Instrumentation Tools

Totally Integrated Automation Portal					
DI 16/DQ 16 [X11]\Outputs\Channel 6					
Parameter settings	From template				
DI 16/DQ 16 [X11]\Outputs\Channel 6\Diagnostics					
No supply voltage L+	False				
DI 16/DQ 16 [X11]\Outputs\Channel 6\Output parameters					
Reaction to CPU STOP	Shutdown				
DI 16/DQ 16 [X11]\Outputs\Channel 7					
Parameter settings	From template				
DI 16/DQ 16 [X11]\Outputs\Channel 7\Diagnostics					
No supply voltage L+	False				
DI 16/DQ 16 [X11]\Outputs\Channel 7\Output parameters					
Reaction to CPU STOP	Shutdown				
DI 16/DQ 16 [X11]\Outputs\Channel 8					
Parameter settings	From template				
DI 16/DQ 16 [X11]\Outputs\Channel 8\Diagnostics					
No supply voltage L+	False				
DI 16/DQ 16 [X11]\Outputs\Channel 8\Output parameters					
Reaction to CPU STOP	Shutdown				
DI 16/DQ 16 [X11]\Outputs\Channel 9					
Parameter settings	From template				
DI 16/DQ 16 [X11]\Outputs\Channel 9\Diagnostics					
No supply voltage L+	False				
DI 16/DQ 16 [X11]\Outputs\Channel 9\Output parameters					
Reaction to CPU STOP	Shutdown				
DI 16/DQ 16 [X11]\Outputs\Channel 10					
Parameter settings	From template				
DI 16/DQ 16 [X11]\Outputs\Channel 10\Diagnostics					
No supply voltage L+	False				
DI 16/DQ 16 [X11]\Outputs\Channel 10\Output parameters					
Reaction to CPU STOP	Shutdown				
DI 16/DQ 16 [X11]\Outputs\Channel 11					
Parameter settings	From template				
DI 16/DQ 16 [X11]\Outputs\Channel 11\Diagnostics					
No supply voltage L+	False				
DI 16/DQ 16 [X11]\Outputs\Channel 11\Output parameters					
Reaction to CPU STOP	Shutdown				
DI 16/DQ 16 [X11]\Outputs\Channel 12					
Parameter settings	From template				
DI 16/DQ 16 [X11]\Outputs\Channel 12\Diagnostics					
No supply voltage L+	False				
DI 16/DQ 16 [X11]\Outputs\Channel 12\Output parameters					
Reaction to CPU STOP	Shutdown				
DI 16/DQ 16 [X11]\Outputs\Channel 13					
Parameter settings	From template				
DI 16/DQ 16 [X11]\Outputs\Channel 13\Diagnostics					
No supply voltage L+	False				
DI 16/DQ 16 [X11]\Outputs\Channel 13\Output parameters					
Reaction to CPU STOP	Shutdown				
DI 16/DQ 16 [X11]\Outputs\Channel 14					
Parameter settings	From template				
DI 16/DQ 16 [X11]\Outputs\Channel 14\Diagnostics					
No supply voltage L+	False				
DI 16/DQ 16 [X11]\Outputs\Channel 14\Output parameters					
Reaction to CPU STOP	Shutdown				
DI 16/DQ 16 [X11]\Outputs\Channel 15					
Parameter settings	From template				
DI 16/DQ 16 [X11]\Outputs\Channel 15\Diagnostics					
No supply voltage L+	False				
DI 16/DQ 16 [X11]\Outputs\Channel 15\Output parameters					
Reaction to CPU STOP	Shutdown				
DI 16/DQ 16 [X11]\I/O addresses\Input addresses					
Start address	10.0	End address	11.7	Organization block	0
Process image	0				
DI 16/DQ 16 [X11]\I/O addresses\Output addresses					
Start address	4.0	End address	5.7	Organization block	0
Process image	0				
DI 16/DQ 16 [X12]\General					
Name	DI 16/DQ 16_2		Comment		
DI 16/DQ 16 [X12]\Channel template\Inputs\Apply to all channels that use the template\Diagnostics					
No supply voltage L+	False				
DI 16/DQ 16 [X12]\Channel template\Inputs\Apply to all channels that use the template\Input parameters					
Input delay	3.2ms				
DI 16/DQ 16 [X12]\Channel template\Outputs\Apply to all channels that use the template\Diagnostics					
No supply voltage L+	False				
DI 16/DQ 16 [X12]\Channel template\Outputs\Apply to all channels that use the template\Output parameters					
Reaction to CPU STOP	Shutdown				
DI 16/DQ 16 [X12]\DI/DQ configuration\Value status (Quality Information)					
Value status	False				
DI 16/DQ 16 [X12]\Inputs\Channel 0					
Parameter settings	From template				
DI 16/DQ 16 [X12]\Inputs\Channel 0\Diagnostics					
No supply voltage L+	False				
DI 16/DQ 16 [X12]\Inputs\Channel 0\Input parameters					
Input delay	3.2ms				

Instrumentation Tools

Totally Integrated Automation Portal					
DI 16/DQ 16 [X12]\Inputs\Channel 0\Hardware interrupts\					
Enable rising edge detection	0	RidPrefixRisingEdgeEvent	49152	Event name:	
Hardware interrupt:	0	Rising edge0	Rising edge0	Channel number	0
HwEventTypeRisingEdge	1				
DI 16/DQ 16 [X12]\Inputs\Channel 0\Hardware interrupts\					
Enable falling edge detection	0	RidPrefixFallingEdgeEvent	49280	Event name:	
Hardware interrupt:	0	Falling edge0	Falling edge0	Channel number	0
HwEventTypeFallingEdge	2				
DI 16/DQ 16 [X12]\Inputs\Channel 1					
Parameter settings	From template				
DI 16/DQ 16 [X12]\Inputs\Channel 1\Diagnostics					
No supply voltage L+	False				
DI 16/DQ 16 [X12]\Inputs\Channel 1\Input parameters					
Input delay	3.2ms				
DI 16/DQ 16 [X12]\Inputs\Channel 1\Hardware interrupts\					
Enable rising edge detection	0	RidPrefixRisingEdgeEvent	49153	Event name:	
Hardware interrupt:	0	Rising edge1	Rising edge1	Channel number	1
HwEventTypeRisingEdge	1				
DI 16/DQ 16 [X12]\Inputs\Channel 1\Hardware interrupts\					
Enable falling edge detection	0	RidPrefixFallingEdgeEvent	49281	Event name:	
Hardware interrupt:	0	Falling edge1	Falling edge1	Channel number	1
HwEventTypeFallingEdge	2				
DI 16/DQ 16 [X12]\Inputs\Channel 2					
Parameter settings	From template				
DI 16/DQ 16 [X12]\Inputs\Channel 2\Diagnostics					
No supply voltage L+	False				
DI 16/DQ 16 [X12]\Inputs\Channel 2\Input parameters					
Input delay	3.2ms				
DI 16/DQ 16 [X12]\Inputs\Channel 2\Hardware interrupts\					
Enable rising edge detection	0	RidPrefixRisingEdgeEvent	49154	Event name:	
Hardware interrupt:	0	Rising edge2	Rising edge2	Channel number	2
HwEventTypeRisingEdge	1				
DI 16/DQ 16 [X12]\Inputs\Channel 2\Hardware interrupts\					
Enable falling edge detection	0	RidPrefixFallingEdgeEvent	49282	Event name:	
Hardware interrupt:	0	Falling edge2	Falling edge2	Channel number	2
HwEventTypeFallingEdge	2				
DI 16/DQ 16 [X12]\Inputs\Channel 3					
Parameter settings	From template				
DI 16/DQ 16 [X12]\Inputs\Channel 3\Diagnostics					
No supply voltage L+	False				
DI 16/DQ 16 [X12]\Inputs\Channel 3\Input parameters					
Input delay	3.2ms				
DI 16/DQ 16 [X12]\Inputs\Channel 3\Hardware interrupts\					
Enable rising edge detection	0	RidPrefixRisingEdgeEvent	49155	Event name:	
Hardware interrupt:	0	Rising edge3	Rising edge3	Channel number	3
HwEventTypeRisingEdge	1				
DI 16/DQ 16 [X12]\Inputs\Channel 3\Hardware interrupts\					
Enable falling edge detection	0	RidPrefixFallingEdgeEvent	49283	Event name:	
Hardware interrupt:	0	Falling edge3	Falling edge3	Channel number	3
HwEventTypeFallingEdge	2				
DI 16/DQ 16 [X12]\Inputs\Channel 4					
Parameter settings	From template				
DI 16/DQ 16 [X12]\Inputs\Channel 4\Diagnostics					
No supply voltage L+	False				
DI 16/DQ 16 [X12]\Inputs\Channel 4\Input parameters					
Input delay	3.2ms				
DI 16/DQ 16 [X12]\Inputs\Channel 4\Hardware interrupts\					
Enable rising edge detection	0	RidPrefixRisingEdgeEvent	49156	Event name:	
Hardware interrupt:	0	Rising edge4	Rising edge4	Channel number	4
HwEventTypeRisingEdge	1				
DI 16/DQ 16 [X12]\Inputs\Channel 4\Hardware interrupts\					
Enable falling edge detection	0	RidPrefixFallingEdgeEvent	49284	Event name:	
Hardware interrupt:	0	Falling edge4	Falling edge4	Channel number	4
HwEventTypeFallingEdge	2				
DI 16/DQ 16 [X12]\Inputs\Channel 5					
Parameter settings	From template				
DI 16/DQ 16 [X12]\Inputs\Channel 5\Diagnostics					
No supply voltage L+	False				

Instrumentation Tools

Totally Integrated Automation Portal					
DI 16/DQ 16 [X12]\Inputs\Channel 5\Input parameters					
Input delay	3.2ms				
DI 16/DQ 16 [X12]\Inputs\Channel 5\Hardware interrupts\					
Enable rising edge detection	0	RidPrefixRisingEdgeEvent	49157	Event name:	
Hardware interrupt:	0	Rising edge5	Rising edge5	Channel number	5
HwEventTypeRisingEdge	1				
DI 16/DQ 16 [X12]\Inputs\Channel 5\Hardware interrupts\					
Enable falling edge detection	0	RidPrefixFallingEdgeEvent	49285	Event name:	
Hardware interrupt:	0	Falling edge5	Falling edge5	Channel number	5
HwEventTypeFallingEdge	2				
DI 16/DQ 16 [X12]\Inputs\Channel 6					
Parameter settings	From template				
DI 16/DQ 16 [X12]\Inputs\Channel 6\Diagnostics					
No supply voltage L+	False				
DI 16/DQ 16 [X12]\Inputs\Channel 6\Input parameters					
Input delay	3.2ms				
DI 16/DQ 16 [X12]\Inputs\Channel 6\Hardware interrupts\					
Enable rising edge detection	0	RidPrefixRisingEdgeEvent	49158	Event name:	
Hardware interrupt:	0	Rising edge6	Rising edge6	Channel number	6
HwEventTypeRisingEdge	1				
DI 16/DQ 16 [X12]\Inputs\Channel 6\Hardware interrupts\					
Enable falling edge detection	0	RidPrefixFallingEdgeEvent	49286	Event name:	
Hardware interrupt:	0	Falling edge6	Falling edge6	Channel number	6
HwEventTypeFallingEdge	2				
DI 16/DQ 16 [X12]\Inputs\Channel 7					
Parameter settings	From template				
DI 16/DQ 16 [X12]\Inputs\Channel 7\Diagnostics					
No supply voltage L+	False				
DI 16/DQ 16 [X12]\Inputs\Channel 7\Input parameters					
Input delay	3.2ms				
DI 16/DQ 16 [X12]\Inputs\Channel 7\Hardware interrupts\					
Enable rising edge detection	0	RidPrefixRisingEdgeEvent	49159	Event name:	
Hardware interrupt:	0	Rising edge7	Rising edge7	Channel number	7
HwEventTypeRisingEdge	1				
DI 16/DQ 16 [X12]\Inputs\Channel 7\Hardware interrupts\					
Enable falling edge detection	0	RidPrefixFallingEdgeEvent	49287	Event name:	
Hardware interrupt:	0	Falling edge7	Falling edge7	Channel number	7
HwEventTypeFallingEdge	2				
DI 16/DQ 16 [X12]\Inputs\Channel 8					
Parameter settings	From template				
DI 16/DQ 16 [X12]\Inputs\Channel 8\Diagnostics					
No supply voltage L+	False				
DI 16/DQ 16 [X12]\Inputs\Channel 8\Input parameters					
Input delay	3.2ms				
DI 16/DQ 16 [X12]\Inputs\Channel 8\Hardware interrupts\					
Enable rising edge detection	0	RidPrefixRisingEdgeEvent	49160	Event name:	
Hardware interrupt:	0	Rising edge8	Rising edge8	Channel number	8
HwEventTypeRisingEdge	1				
DI 16/DQ 16 [X12]\Inputs\Channel 8\Hardware interrupts\					
Enable falling edge detection	0	RidPrefixFallingEdgeEvent	49288	Event name:	
Hardware interrupt:	0	Falling edge8	Falling edge8	Channel number	8
HwEventTypeFallingEdge	2				
DI 16/DQ 16 [X12]\Inputs\Channel 9					
Parameter settings	From template				
DI 16/DQ 16 [X12]\Inputs\Channel 9\Diagnostics					
No supply voltage L+	False				
DI 16/DQ 16 [X12]\Inputs\Channel 9\Input parameters					
Input delay	3.2ms				
DI 16/DQ 16 [X12]\Inputs\Channel 9\Hardware interrupts\					
Enable rising edge detection	0	RidPrefixRisingEdgeEvent	49161	Event name:	
Hardware interrupt:	0	Rising edge9	Rising edge9	Channel number	9
HwEventTypeRisingEdge	1				
DI 16/DQ 16 [X12]\Inputs\Channel 9\Hardware interrupts\					
Enable falling edge detection	0	RidPrefixFallingEdgeEvent	49289	Event name:	
Hardware interrupt:	0	Falling edge9	Falling edge9	Channel number	9
HwEventTypeFallingEdge	2				
DI 16/DQ 16 [X12]\Inputs\Channel 10					
Parameter settings	From template				

Instrumentation Tools

Totally Integrated Automation Portal					
DI 16/DQ 16 [X12]\Inputs\Channel 10\Diagnostics					
No supply voltage L+	False				
DI 16/DQ 16 [X12]\Inputs\Channel 10\Input parameters					
Input delay	3.2ms				
DI 16/DQ 16 [X12]\Inputs\Channel 10\Hardware interrupts\					
Enable rising edge detection	0	RidPrefixRisingEdgeEvent	49162	Event name:	
Hardware interrupt:	0	Rising edge10	Rising edge10	Channel number	10
HwEventTypeRisingEdge	1				
DI 16/DQ 16 [X12]\Inputs\Channel 10\Hardware interrupts\					
Enable falling edge detection	0	RidPrefixFallingEdgeEvent	49290	Event name:	0
Hardware interrupt:	0	Falling edge10	Falling edge10	Channel number	10
HwEventTypeFallingEdge	2				
DI 16/DQ 16 [X12]\Inputs\Channel 11					
Parameter settings	From template				
DI 16/DQ 16 [X12]\Inputs\Channel 11\Diagnostics					
No supply voltage L+	False				
DI 16/DQ 16 [X12]\Inputs\Channel 11\Input parameters					
Input delay	3.2ms				
DI 16/DQ 16 [X12]\Inputs\Channel 11\Hardware interrupts\					
Enable rising edge detection	0	RidPrefixRisingEdgeEvent	49163	Event name:	
Hardware interrupt:	0	Rising edge11	Rising edge11	Channel number	11
HwEventTypeRisingEdge	1				
DI 16/DQ 16 [X12]\Inputs\Channel 11\Hardware interrupts\					
Enable falling edge detection	0	RidPrefixFallingEdgeEvent	49291	Event name:	
Hardware interrupt:	0	Falling edge11	Falling edge11	Channel number	11
HwEventTypeFallingEdge	2				
DI 16/DQ 16 [X12]\Inputs\Channel 12					
Parameter settings	From template				
DI 16/DQ 16 [X12]\Inputs\Channel 12\Diagnostics					
No supply voltage L+	False				
DI 16/DQ 16 [X12]\Inputs\Channel 12\Input parameters					
Input delay	3.2ms				
DI 16/DQ 16 [X12]\Inputs\Channel 12\Hardware interrupts\					
Enable rising edge detection	0	RidPrefixRisingEdgeEvent	49164	Event name:	
Hardware interrupt:	0	Rising edge12	Rising edge12	Channel number	12
HwEventTypeRisingEdge	1				
DI 16/DQ 16 [X12]\Inputs\Channel 12\Hardware interrupts\					
Enable falling edge detection	0	RidPrefixFallingEdgeEvent	49292	Event name:	
Hardware interrupt:	0	Falling edge12	Falling edge12	Channel number	12
HwEventTypeFallingEdge	2				
DI 16/DQ 16 [X12]\Inputs\Channel 13					
Parameter settings	From template				
DI 16/DQ 16 [X12]\Inputs\Channel 13\Diagnostics					
No supply voltage L+	False				
DI 16/DQ 16 [X12]\Inputs\Channel 13\Input parameters					
Input delay	3.2ms				
DI 16/DQ 16 [X12]\Inputs\Channel 13\Hardware interrupts\					
Enable rising edge detection	0	RidPrefixRisingEdgeEvent	49165	Event name:	
Hardware interrupt:	0	Rising edge13	Rising edge13	Channel number	13
HwEventTypeRisingEdge	1				
DI 16/DQ 16 [X12]\Inputs\Channel 13\Hardware interrupts\					
Enable falling edge detection	0	RidPrefixFallingEdgeEvent	49293	Event name:	
Hardware interrupt:	0	Falling edge13	Falling edge13	Channel number	13
HwEventTypeFallingEdge	2				
DI 16/DQ 16 [X12]\Inputs\Channel 14					
Parameter settings	From template				
DI 16/DQ 16 [X12]\Inputs\Channel 14\Diagnostics					
No supply voltage L+	False				
DI 16/DQ 16 [X12]\Inputs\Channel 14\Input parameters					
Input delay	3.2ms				
DI 16/DQ 16 [X12]\Inputs\Channel 14\Hardware interrupts\					
Enable rising edge detection	0	RidPrefixRisingEdgeEvent	49166	Event name:	
Hardware interrupt:	0	Rising edge14	Rising edge14	Channel number	14
HwEventTypeRisingEdge	1				
DI 16/DQ 16 [X12]\Inputs\Channel 14\Hardware interrupts\					
Enable falling edge detection	0	RidPrefixFallingEdgeEvent	49294	Event name:	
Hardware interrupt:	0	Falling edge14	Falling edge14	Channel number	14
HwEventTypeFallingEdge	2				

Instrumentation Tools

Totally Integrated Automation Portal		
DI 16/DQ 16 [X12]\Inputs\Channel 15		
Parameter settings	From template	
DI 16/DQ 16 [X12]\Inputs\Channel 15\Diagnostics		
No supply voltage L+	False	
DI 16/DQ 16 [X12]\Inputs\Channel 15\Input parameters		
Input delay	3.2ms	
DI 16/DQ 16 [X12]\Inputs\Channel 15\Hardware interrupts\		
Enable rising edge detection	0	RidPrefixRisingEdgeEvent 49167
Hardware interrupt:	0	Rising edge15 Rising edge15
HwEventTypeRisingEdge	1	Channel number 15
DI 16/DQ 16 [X12]\Inputs\Channel 15\Hardware interrupts\		
Enable falling edge detection	0	RidPrefixFallingEdgeEvent 49295
Hardware interrupt:	0	Falling edge15 Falling edge15
HwEventTypeFallingEdge	2	Channel number 15
DI 16/DQ 16 [X12]\Outputs\Channel 0		
Parameter settings	From template	
DI 16/DQ 16 [X12]\Outputs\Channel 0\Diagnostics		
No supply voltage L+	False	
DI 16/DQ 16 [X12]\Outputs\Channel 0\Output parameters		
Reaction to CPU STOP	Shutdown	
DI 16/DQ 16 [X12]\Outputs\Channel 1		
Parameter settings	From template	
DI 16/DQ 16 [X12]\Outputs\Channel 1\Diagnostics		
No supply voltage L+	False	
DI 16/DQ 16 [X12]\Outputs\Channel 1\Output parameters		
Reaction to CPU STOP	Shutdown	
DI 16/DQ 16 [X12]\Outputs\Channel 2		
Parameter settings	From template	
DI 16/DQ 16 [X12]\Outputs\Channel 2\Diagnostics		
No supply voltage L+	False	
DI 16/DQ 16 [X12]\Outputs\Channel 2\Output parameters		
Reaction to CPU STOP	Shutdown	
DI 16/DQ 16 [X12]\Outputs\Channel 3		
Parameter settings	From template	
DI 16/DQ 16 [X12]\Outputs\Channel 3\Diagnostics		
No supply voltage L+	False	
DI 16/DQ 16 [X12]\Outputs\Channel 3\Output parameters		
Reaction to CPU STOP	Shutdown	
DI 16/DQ 16 [X12]\Outputs\Channel 4		
Parameter settings	From template	
DI 16/DQ 16 [X12]\Outputs\Channel 4\Diagnostics		
No supply voltage L+	False	
DI 16/DQ 16 [X12]\Outputs\Channel 4\Output parameters		
Reaction to CPU STOP	Shutdown	
DI 16/DQ 16 [X12]\Outputs\Channel 5		
Parameter settings	From template	
DI 16/DQ 16 [X12]\Outputs\Channel 5\Diagnostics		
No supply voltage L+	False	
DI 16/DQ 16 [X12]\Outputs\Channel 5\Output parameters		
Reaction to CPU STOP	Shutdown	
DI 16/DQ 16 [X12]\Outputs\Channel 6		
Parameter settings	From template	
DI 16/DQ 16 [X12]\Outputs\Channel 6\Diagnostics		
No supply voltage L+	False	
DI 16/DQ 16 [X12]\Outputs\Channel 6\Output parameters		
Reaction to CPU STOP	Shutdown	
DI 16/DQ 16 [X12]\Outputs\Channel 7		
Parameter settings	From template	
DI 16/DQ 16 [X12]\Outputs\Channel 7\Diagnostics		
No supply voltage L+	False	
DI 16/DQ 16 [X12]\Outputs\Channel 7\Output parameters		
Reaction to CPU STOP	Shutdown	
DI 16/DQ 16 [X12]\Outputs\Channel 8		
Parameter settings	From template	
DI 16/DQ 16 [X12]\Outputs\Channel 8\Diagnostics		
No supply voltage L+	False	
DI 16/DQ 16 [X12]\Outputs\Channel 8\Output parameters		
Reaction to CPU STOP	Shutdown	
DI 16/DQ 16 [X12]\Outputs\Channel 9		
Parameter settings	From template	
DI 16/DQ 16 [X12]\Outputs\Channel 9\Diagnostics		
No supply voltage L+	False	
DI 16/DQ 16 [X12]\Outputs\Channel 9\Output parameters		
Reaction to CPU STOP	Shutdown	
DI 16/DQ 16 [X12]\Outputs\Channel 10		
Parameter settings	From template	
DI 16/DQ 16 [X12]\Outputs\Channel 10\Diagnostics		
No supply voltage L+	False	
DI 16/DQ 16 [X12]\Outputs\Channel 10\Output parameters		
Reaction to CPU STOP	Shutdown	
DI 16/DQ 16 [X12]\Outputs\Channel 11		
Parameter settings	From template	

Instrumentation Tools

Totally Integrated Automation Portal					
DI 16/DQ 16 [X12]\Outputs\Channel 11\Diagnostics					
No supply voltage L+	False				
DI 16/DQ 16 [X12]\Outputs\Channel 11\Output parameters					
Reaction to CPU STOP	Shutdown				
DI 16/DQ 16 [X12]\Outputs\Channel 12					
Parameter settings	From template				
DI 16/DQ 16 [X12]\Outputs\Channel 12\Diagnostics					
No supply voltage L+	False				
DI 16/DQ 16 [X12]\Outputs\Channel 12\Output parameters					
Reaction to CPU STOP	Shutdown				
DI 16/DQ 16 [X12]\Outputs\Channel 13					
Parameter settings	From template				
DI 16/DQ 16 [X12]\Outputs\Channel 13\Diagnostics					
No supply voltage L+	False				
DI 16/DQ 16 [X12]\Outputs\Channel 13\Output parameters					
Reaction to CPU STOP	Shutdown				
DI 16/DQ 16 [X12]\Outputs\Channel 14					
Parameter settings	From template				
DI 16/DQ 16 [X12]\Outputs\Channel 14\Diagnostics					
No supply voltage L+	False				
DI 16/DQ 16 [X12]\Outputs\Channel 14\Output parameters					
Reaction to CPU STOP	Shutdown				
DI 16/DQ 16 [X12]\Outputs\Channel 15					
Parameter settings	From template				
DI 16/DQ 16 [X12]\Outputs\Channel 15\Diagnostics					
No supply voltage L+	False				
DI 16/DQ 16 [X12]\Outputs\Channel 15\Output parameters					
Reaction to CPU STOP	Shutdown				
DI 16/DQ 16 [X12]\I/O addresses\Input addresses					
Start address	12.0	End address	13.7	Organization block	0
Process image	0				
DI 16/DQ 16 [X12]\I/O addresses\Output addresses					
Start address	6.0	End address	7.7	Organization block	0
Process image	0				
High speed counters (HSC)\CPU 1511C compatibility					
Front connector assignment like CPU 1511C	False				
High speed counters (HSC)\HSC 1\General\Enable					
Activate this high-speed counter	False				
High speed counters (HSC)\HSC 1\General\Project information					
Name	HSC_1	Author	Mmuhammed	Comment	
High speed counters (HSC)\HSC 1\Channel 0\Operating mode					
Selection of operating mode	Operating with technology object "Counting and measurement"				
High speed counters (HSC)\HSC 1\Channel 0\Reaction to CPU STOP					
Reaction to CPU STOP	Output substitute value	Substitute value for DQ0	0	Substitute value for DQ1	0
High speed counters (HSC)\HSC 1\Channel 0\Diagnostic interrupts					
Enable diagnostic interrupts	False				
High speed counters (HSC)\HSC 1\Channel 0\Hardware interrupts\Hardware interrupt triggered by external events\					
New capture value available	0	RidPrefixCaptureEvent	49280	Event name	
Hardware interrupt	0	Capture value0	Capture value0	Channel number	0
HwEventTypeCapture	8				
High speed counters (HSC)\HSC 1\Channel 0\Hardware interrupts\Hardware interrupt triggered by external events\					
Synchronization of the counter by an external signal	0	RidPrefixSyncEvent	49296	Event name	
Hardware interrupt	0	Synchronization0	Synchronization0	Channel number	0
HwEventTypeSync	9				
High speed counters (HSC)\HSC 1\Channel 0\Hardware interrupts\Hardware interrupt triggered by external events\					
Gate start	0	RidPrefixGateStartEvent	49168	Event name	
Hardware interrupt	0	Gate start0	Gate start0	Channel number	0
HwEventTypeGateStart	1				
High speed counters (HSC)\HSC 1\Channel 0\Hardware interrupts\Hardware interrupt triggered by external events\					
Gate stop	0	RidPrefixGateStopEvent	49184	Event name	
Hardware interrupt	0	Gate stop0	Gate stop0	Channel number	0
HwEventTypeGateStop	2				
High speed counters (HSC)\HSC 1\Channel 0\Hardware interrupts\Hardware interrupt by counter value/position value\					
Overflow (high counting limit violated)	0	RidPrefixOverflowEvent	49200	Event name	
Hardware interrupt	0	Overflow0	Overflow0	Channel number	0
HwEventTypeOverflow	3				
High speed counters (HSC)\HSC 1\Channel 0\Hardware interrupts\Hardware interrupt by counter value/position value\					
Underflow (low counting limit violated)	0	RidPrefixUnderflowEvent	49216	Event name	
Hardware interrupt	0	Underflow0	Underflow0	Channel number	0
HwEventTypeUnderflow	4				

Instrumentation Tools

Totally Integrated Automation Portal					
High speed counters (HSC)\HSC 1\Channel 0\Hardware interrupts\Hardware interrupt by counter value/position value\					
Direction reversal	0	RidPrefixDirection-ChangedEvent	49312	Event name	
Hardware interrupt	0	Direction reversal0	Direction reversal0	Channel number	0
HwEventTypeDirectionChanged	10				
High speed counters (HSC)\HSC 1\Channel 0\Hardware interrupts\Hardware interrupt by counter value/position value\					
Zero crossing	0	RidPrefixZeroCrossingEvent	49264	Event name	
Hardware interrupt	0	Zero crossing0	Zero crossing0	Channel number	0
HwEventTypeZeroCrossing	7				
High speed counters (HSC)\HSC 1\Channel 0\Hardware interrupts\Hardware interrupt by counter value/position value\					
Comparison event for DQ0 occurred	0	RidPrefixCompare0Event	49232	Event name	
Hardware interrupt	0	Compare event DQ00	Compare event DQ00	Channel number	0
HwEventTypeCompare0	5				
High speed counters (HSC)\HSC 1\Channel 0\Hardware interrupts\Hardware interrupt by counter value/position value\					
Comparison event for DQ1 occurred	0	RidPrefixCompare1Event	49248	Event name	
Hardware interrupt	0	Compare event DQ10	Compare event DQ10	Channel number	0
HwEventTypeCompare1	6				
High speed counters (HSC)\HSC 1\Channel 0\Counter inputs\Specify input signals/encoder type					
Signal type	Pulse (A) and direction (B)		Invert direction	False	
High speed counters (HSC)\HSC 1\Channel 0\Counter inputs\Additional parameters					
Signal evaluation	Single	Filter frequency	100 kHz	Reaction to signal N	No reaction to signal N
High speed counters (HSC)\HSC 1\Channel 0\Counter behavior\Counting limits and start value					
High counting limit	2147483647	Start value	0	Low counting limit	-2147483648
High speed counters (HSC)\HSC 1\Channel 0\Counter behavior\Counter behavior at limits and gate start					
Reaction to violation of a counting limit	Continue counting	Reset when counting limit is violated	To opposite counting limit	Reaction to gate start	Continue with current value
High speed counters (HSC)\HSC 1\Channel 0\Behavior of inputs\Behavior of DI0\Function of DI0					
Set function of DI	Digital input without function	HSC DI0	None	Input delay	No input for DI0 selected
High speed counters (HSC)\HSC 1\Channel 0\Behavior of inputs\Behavior of DI1\Function of DI1					
Set function of DI	Digital input without function	HSC DI1	None	Input delay	No input for DI1 selected
High speed counters (HSC)\HSC 1\Channel 0\Behavior of outputs\Behavior of DQ0\Function of DQ0					
Set output	Between comparison value 0 and high limit	Comparison value 0	0	Comparison value 1	10
Count direction	In both directions	Pulse duration	500.0ms	Substitute value for DQ0	0
HSC DQ0	Only available via feedback interface				
High speed counters (HSC)\HSC 1\Channel 0\Behavior of outputs\Behavior of DQ1\Function of DQ1					
Set output	Between comparison value 1 and high limit	Comparison value 0	0	Comparison value 1	10
Count direction	In both directions	Pulse duration	500.0ms	Substitute value for DQ1	0
HSC DQ1	None				
High speed counters (HSC)\HSC 1\Channel 0\Hysteresis\Set hysteresis range					
Hysteresis (in increments)	0				
High speed counters (HSC)\HSC 1\Channel 0\Measured value\Specify measured value					
Measured variable	Frequency	Update time	10.000ms		
High speed counters (HSC)\HSC 1\Hardware inputs/outputs					
Pulse input (A)	X11, Clamp 1 (DI0 / %I10.0)	Direction input (B)	X11, Clamp 2 (DI1 / %I10.1)	Reset input (N)	None
HSC DI0	None	HSC DI1	None	HSC DQ0	Only available via feedback interface
HSC DQ1	None				
High speed counters (HSC)\HSC 1\I/O addresses\Input addresses					
Start address	14.0	End address	29.7	Organization block	0
Process image	0				
High speed counters (HSC)\HSC 1\I/O addresses\Output addresses					
Start address	8.0	End address	19.7	Organization block	0
Process image	0				
High speed counters (HSC)\HSC 2\General\Enable					
Activate this high-speed counter	False				
High speed counters (HSC)\HSC 2\General\Project information					
Name	HSC_2	Author	Mmuhammed	Comment	
High speed counters (HSC)\HSC 2\Channel 0\Operating mode					
Selection of operating mode	Operating with technology object "Counting and measurement"				
High speed counters (HSC)\HSC 2\Channel 0\Reaction to CPU STOP					
Reaction to CPU STOP	Output substitute value	Substitute value for DQ0	0	Substitute value for DQ1	0
High speed counters (HSC)\HSC 2\Channel 0\Diagnostic interrupts					
Enable diagnostic interrupts	False				
High speed counters (HSC)\HSC 2\Channel 0\Hardware interrupts\Hardware interrupt triggered by external events\					
New capture value available	0	RidPrefixCaptureEvent	49280	Event name	
Hardware interrupt	0	Capture value0	Capture value0	Channel number	0
HwEventTypeCapture	8				
High speed counters (HSC)\HSC 2\Channel 0\Hardware interrupts\Hardware interrupt triggered by external events\					
Synchronization of the counter by an external signal	0	RidPrefixSyncEvent	49296	Event name	
Hardware interrupt	0	Synchronization0	Synchronization0	Channel number	0
HwEventTypeSync	9				

Instrumentation Tools

Totally Integrated Automation Portal					
High speed counters (HSC)\HSC 2\Channel 0\Hardware interrupts\Hardware interrupt triggered by external events\					
Gate start	0	RidPrefixGateStartEvent	49168	Event name	
Hardware interrupt	0	Gate start0	Gate start0	Channel number	0
HwEventTypeGateStart	1				
High speed counters (HSC)\HSC 2\Channel 0\Hardware interrupts\Hardware interrupt triggered by external events\					
Gate stop	0	RidPrefixGateStopEvent	49184	Event name	
Hardware interrupt	0	Gate stop0	Gate stop0	Channel number	0
HwEventTypeGateStop	2				
High speed counters (HSC)\HSC 2\Channel 0\Hardware interrupts\Hardware interrupt by counter value/position value\					
Overflow (high counting limit violated)	0	RidPrefixOverflowEvent	49200	Event name	
Hardware interrupt	0	Overflow0	Overflow0	Channel number	0
HwEventTypeOverflow	3				
High speed counters (HSC)\HSC 2\Channel 0\Hardware interrupts\Hardware interrupt by counter value/position value\					
Underflow (low counting limit violated)	0	RidPrefixUnderflowEvent	49216	Event name	
Hardware interrupt	0	Underflow0	Underflow0	Channel number	0
HwEventTypeUnderflow	4				
High speed counters (HSC)\HSC 2\Channel 0\Hardware interrupts\Hardware interrupt by counter value/position value\					
Direction reversal	0	RidPrefixDirectionChangedEvent	49312	Event name	
Hardware interrupt	0	Direction reversal0	Direction reversal0	Channel number	0
HwEventTypeDirectionChanged	10				
High speed counters (HSC)\HSC 2\Channel 0\Hardware interrupts\Hardware interrupt by counter value/position value\					
Zero crossing	0	RidPrefixZeroCrossingEvent	49264	Event name	
Hardware interrupt	0	Zero crossing0	Zero crossing0	Channel number	0
HwEventTypeZeroCrossing	7				
High speed counters (HSC)\HSC 2\Channel 0\Hardware interrupts\Hardware interrupt by counter value/position value\					
Comparison event for DQ0 occurred	0	RidPrefixCompare0Event	49232	Event name	
Hardware interrupt	0	Compare event DQ00	Compare event DQ00	Channel number	0
HwEventTypeCompare0	5				
High speed counters (HSC)\HSC 2\Channel 0\Hardware interrupts\Hardware interrupt by counter value/position value\					
Comparison event for DQ1 occurred	0	RidPrefixCompare1Event	49248	Event name	
Hardware interrupt	0	Compare event DQ10	Compare event DQ10	Channel number	0
HwEventTypeCompare1	6				
High speed counters (HSC)\HSC 2\Channel 0\Counter inputs\Specify input signals/encoder type					
Signal type	Pulse (A) and direction (B)	Invert direction	False		
High speed counters (HSC)\HSC 2\Channel 0\Counter inputs\Additional parameters					
Signal evaluation	Single	Filter frequency	100 kHz	Reaction to signal N	No reaction to signal N
High speed counters (HSC)\HSC 2\Channel 0\Counter behavior\Counting limits and start value					
High counting limit	2147483647	Start value	0	Low counting limit	-2147483648
High speed counters (HSC)\HSC 2\Channel 0\Counter behavior\Counter behavior at limits and gate start					
Reaction to violation of a counting limit	Continue counting	Reset when counting limit is violated	To opposite counting limit	Reaction to gate start	Continue with current value
High speed counters (HSC)\HSC 2\Channel 0\Behavior of inputs\Behavior of DI0\Function of DI0					
Set function of DI	Digital input without function	HSC DI0	None	Input delay	No input for DI0 selected
High speed counters (HSC)\HSC 2\Channel 0\Behavior of inputs\Behavior of DI1\Function of DI1					
Set function of DI	Digital input without function	HSC DI1	None	Input delay	No input for DI1 selected
High speed counters (HSC)\HSC 2\Channel 0\Behavior of outputs\Behavior of DQ0\Function of DQ0					
Set output	Between comparison value 0 and high limit	Comparison value 0	0	Comparison value 1	10
Count direction	In both directions	Pulse duration	500.0ms	Substitute value for DQ0	0
HSC DQ0	Only available via feedback interface				
High speed counters (HSC)\HSC 2\Channel 0\Behavior of outputs\Behavior of DQ1\Function of DQ1					
Set output	Between comparison value 1 and high limit	Comparison value 0	0	Comparison value 1	10
Count direction	In both directions	Pulse duration	500.0ms	Substitute value for DQ1	0
HSC DQ1	None				
High speed counters (HSC)\HSC 2\Channel 0\Hysteresis\Set hysteresis range					
Hysteresis (in increments)	0				
High speed counters (HSC)\HSC 2\Channel 0\Measured value\Specify measured value					
Measured variable	Frequency	Update time	10.000ms		
High speed counters (HSC)\HSC 2\Hardware inputs/outputs					
Pulse input (A)	X11, Clamp 4 (DI3 / %I10.3)	Direction input (B)	X11, Clamp 5 (DI4 / %I10.4)	Reset input (N)	None
HSC DI0	None	HSC DI1	None	HSC DQ0	Only available via feedback interface
HSC DQ1	None				
High speed counters (HSC)\HSC 2\I/O addresses\Input addresses					
Start address	30.0	End address	45.7	Organization block	0
Process image	0				
High speed counters (HSC)\HSC 2\I/O addresses\Output addresses					
Start address	20.0	End address	31.7	Organization block	0
Process image	0				

Instrumentation Tools

Totally Integrated Automation Portal					
High speed counters (HSC)\HSC 3\General\Enable					
Activate this high-speed counter	False				
High speed counters (HSC)\HSC 3\General\Project information					
Name	HSC_3	Author	Mmuhammed	Comment	
High speed counters (HSC)\HSC 3\Channel 0\Operating mode					
Selection of operating mode	Operating with technology object "Counting and measurement"				
High speed counters (HSC)\HSC 3\Channel 0\Reaction to CPU STOP					
Reaction to CPU STOP	Output substitute value	Substitute value for DQ0	0	Substitute value for DQ1	0
High speed counters (HSC)\HSC 3\Channel 0\Diagnostic interrupts					
Enable diagnostic interrupts	False				
High speed counters (HSC)\HSC 3\Channel 0\Hardware interrupts\Hardware interrupt triggered by external events\					
New capture value available	0	RidPrefixCaptureEvent	49280	Event name	
Hardware interrupt	0	Capture value0	Capture value0	Channel number	0
HwEventTypeCapture	8				
High speed counters (HSC)\HSC 3\Channel 0\Hardware interrupts\Hardware interrupt triggered by external events\					
Synchronization of the counter by an external signal	0	RidPrefixSyncEvent	49296	Event name	
Hardware interrupt	0	Synchronization0	Synchronization0	Channel number	0
HwEventTypeSync	9				
High speed counters (HSC)\HSC 3\Channel 0\Hardware interrupts\Hardware interrupt triggered by external events\					
Gate start	0	RidPrefixGateStartEvent	49168	Event name	
Hardware interrupt	0	Gate start0	Gate start0	Channel number	0
HwEventTypeGateStart	1				
High speed counters (HSC)\HSC 3\Channel 0\Hardware interrupts\Hardware interrupt triggered by external events\					
Gate stop	0	RidPrefixGateStopEvent	49184	Event name	
Hardware interrupt	0	Gate stop0	Gate stop0	Channel number	0
HwEventTypeGateStop	2				
High speed counters (HSC)\HSC 3\Channel 0\Hardware interrupts\Hardware interrupt by counter value/position value\					
Overflow (high counting limit violated)	0	RidPrefixOverflowEvent	49200	Event name	
Hardware interrupt	0	Overflow0	Overflow0	Channel number	0
HwEventTypeOverflow	3				
High speed counters (HSC)\HSC 3\Channel 0\Hardware interrupts\Hardware interrupt by counter value/position value\					
Underflow (low counting limit violated)	0	RidPrefixUnderflowEvent	49216	Event name	
Hardware interrupt	0	Underflow0	Underflow0	Channel number	0
HwEventTypeUnderflow	4				
High speed counters (HSC)\HSC 3\Channel 0\Hardware interrupts\Hardware interrupt by counter value/position value\					
Direction reversal	0	RidPrefixDirectionChangedEvent	49312	Event name	
Hardware interrupt	0	Direction reversal0	Direction reversal0	Channel number	0
HwEventTypeDirectionChanged	10				
High speed counters (HSC)\HSC 3\Channel 0\Hardware interrupts\Hardware interrupt by counter value/position value\					
Zero crossing	0	RidPrefixZeroCrossingEvent	49264	Event name	
Hardware interrupt	0	Zero crossing0	Zero crossing0	Channel number	0
HwEventTypeZeroCrossing	7				
High speed counters (HSC)\HSC 3\Channel 0\Hardware interrupts\Hardware interrupt by counter value/position value\					
Comparison event for DQ0 occurred	0	RidPrefixCompare0Event	49232	Event name	
Hardware interrupt	0	Compare event DQ00	Compare event DQ00	Channel number	0
HwEventTypeCompare0	5				
High speed counters (HSC)\HSC 3\Channel 0\Hardware interrupts\Hardware interrupt by counter value/position value\					
Comparison event for DQ1 occurred	0	RidPrefixCompare1Event	49248	Event name	
Hardware interrupt	0	Compare event DQ10	Compare event DQ10	Channel number	0
HwEventTypeCompare1	6				
High speed counters (HSC)\HSC 3\Channel 0\Counter inputs\Specify input signals/encoder type					
Signal type	Pulse (A) and direction (B)	Invert direction	False		
High speed counters (HSC)\HSC 3\Channel 0\Counter inputs\Additional parameters					
Signal evaluation	Single	Filter frequency	100 kHz	Reaction to signal N	No reaction to signal N
High speed counters (HSC)\HSC 3\Channel 0\Counter behavior\Counting limits and start value					
High counting limit	2147483647	Start value	0	Low counting limit	-2147483648
High speed counters (HSC)\HSC 3\Channel 0\Counter behavior\Counter behavior at limits and gate start					
Reaction to violation of a counting limit	Continue counting	Reset when counting limit is violated	To opposite counting limit	Reaction to gate start	Continue with current value
High speed counters (HSC)\HSC 3\Channel 0\Behavior of inputs\Behavior of DI0\Function of DI0					
Set function of DI	Digital input without function	HSC DI0	None	Input delay	No input for DI0 selected
High speed counters (HSC)\HSC 3\Channel 0\Behavior of inputs\Behavior of DI1\Function of DI1					
Set function of DI	Digital input without function	HSC DI1	None	Input delay	No input for DI1 selected

Instrumentation Tools

Totally Integrated Automation Portal					
High speed counters (HSC)\HSC 3\Channel 0\Behavior of outputs\Behavior of DQ0\Function of DQ0					
Set output	Between comparison value 0 and high limit	Comparison value 0	0	Comparison value 1	10
Count direction	In both directions	Pulse duration	500.0ms	Substitute value for DQ0	0
HSC DQ0	Only available via feedback interface				
High speed counters (HSC)\HSC 3\Channel 0\Behavior of outputs\Behavior of DQ1\Function of DQ1					
Set output	Between comparison value 1 and high limit	Comparison value 0	0	Comparison value 1	10
Count direction	In both directions	Pulse duration	500.0ms	Substitute value for DQ1	0
HSC DQ1	None				
High speed counters (HSC)\HSC 3\Channel 0\Hysteresis\Set hysteresis range					
Hysteresis (in increments)	0				
High speed counters (HSC)\HSC 3\Channel 0\Measured value\Specify measured value					
Measured variable	Frequency	Update time	10.000ms		
High speed counters (HSC)\HSC 3\Hardware inputs/outputs					
Pulse input (A)	X11, Clamp 7 (DI6 / %I10.6)	Direction input (B)	X11, Clamp 8 (DI7 / %I10.7)	Reset input (N)	None
HSC DI0	None	HSC DI1	None	HSC DQ0	Only available via feedback interface
HSC DQ1	None				
High speed counters (HSC)\HSC 3\I/O addresses\Input addresses					
Start address	46.0	End address	61.7	Organization block	0
Process image	0				
High speed counters (HSC)\HSC 3\I/O addresses\Output addresses					
Start address	32.0	End address	43.7	Organization block	0
Process image	0				
High speed counters (HSC)\HSC 4\General\Enable					
Activate this high-speed counter	False				
High speed counters (HSC)\HSC 4\General\Project information					
Name	HSC_4	Author	Mmuhamed	Comment	
High speed counters (HSC)\HSC 4\Channel 0\Operating mode					
Selection of operating mode	Operating with technology object "Counting and measurement"				
High speed counters (HSC)\HSC 4\Channel 0\Reaction to CPU STOP					
Reaction to CPU STOP	Output substitute value	Substitute value for DQ0	0	Substitute value for DQ1	0
High speed counters (HSC)\HSC 4\Channel 0\Diagnostic interrupts					
Enable diagnostic interrupts	False				
High speed counters (HSC)\HSC 4\Channel 0\Hardware interrupts\Hardware interrupt triggered by external events\					
New capture value available	0	RidPrefixCaptureEvent	49280	Event name	
Hardware interrupt	0	Capture value0	Capture value0	Channel number	0
HwEventTypeCapture	8				
High speed counters (HSC)\HSC 4\Channel 0\Hardware interrupts\Hardware interrupt triggered by external events\					
Synchronization of the counter by an external signal	0	RidPrefixSyncEvent	49296	Event name	
Hardware interrupt	0	Synchronization0	Synchronization0	Channel number	0
HwEventTypeSync	9				
High speed counters (HSC)\HSC 4\Channel 0\Hardware interrupts\Hardware interrupt triggered by external events\					
Gate start	0	RidPrefixGateStartEvent	49168	Event name	
Hardware interrupt	0	Gate start0	Gate start0	Channel number	0
HwEventTypeGateStart	1				
High speed counters (HSC)\HSC 4\Channel 0\Hardware interrupts\Hardware interrupt triggered by external events\					
Gate stop	0	RidPrefixGateStopEvent	49184	Event name	
Hardware interrupt	0	Gate stop0	Gate stop0	Channel number	0
HwEventTypeGateStop	2				
High speed counters (HSC)\HSC 4\Channel 0\Hardware interrupts\Hardware interrupt by counter value/position value\					
Overflow (high counting limit violated)	0	RidPrefixOverflowEvent	49200	Event name	
Hardware interrupt	0	Overflow0	Overflow0	Channel number	0
HwEventTypeOverflow	3				
High speed counters (HSC)\HSC 4\Channel 0\Hardware interrupts\Hardware interrupt by counter value/position value\					
Underflow (low counting limit violated)	0	RidPrefixUnderflowEvent	49216	Event name	
Hardware interrupt	0	Underflow0	Underflow0	Channel number	0
HwEventTypeUnderflow	4				
High speed counters (HSC)\HSC 4\Channel 0\Hardware interrupts\Hardware interrupt by counter value/position value\					
Direction reversal	0	RidPrefixDirectionChangedEvent	49312	Event name	
Hardware interrupt	0	Direction reversal0	Direction reversal0	Channel number	0
HwEventTypeDirectionChanged	10				
High speed counters (HSC)\HSC 4\Channel 0\Hardware interrupts\Hardware interrupt by counter value/position value\					
Zero crossing	0	RidPrefixZeroCrossingEvent	49264	Event name	
Hardware interrupt	0	Zero crossing0	Zero crossing0	Channel number	0
HwEventTypeZeroCrossing	7				

Instrumentation Tools

Totally Integrated Automation Portal					
High speed counters (HSC)\HSC 4\Channel 0\Hardware interrupts\Hardware interrupt by counter value/position value\					
Comparison event for DQ0 occurred	0	RidPrefixCompare0Event	49232	Event name	
Hardware interrupt	0	Compare event DQ00	Compare event DQ00	Channel number	0
HwEventTypeCompare0	5				
High speed counters (HSC)\HSC 4\Channel 0\Hardware interrupts\Hardware interrupt by counter value/position value\					
Comparison event for DQ1 occurred	0	RidPrefixCompare1Event	49248	Event name	
Hardware interrupt	0	Compare event DQ10	Compare event DQ10	Channel number	0
HwEventTypeCompare1	6				
High speed counters (HSC)\HSC 4\Channel 0\Counter inputs\Specify input signals/encoder type					
Signal type	Pulse (A) and direction (B)	Invert direction	False		
High speed counters (HSC)\HSC 4\Channel 0\Counter inputs\Additional parameters					
Signal evaluation	Single	Filter frequency	100 kHz	Reaction to signal N	No reaction to signal N
High speed counters (HSC)\HSC 4\Channel 0\Counter behavior\Counting limits and start value					
High counting limit	2147483647	Start value	0	Low counting limit	-2147483648
High speed counters (HSC)\HSC 4\Channel 0\Counter behavior\Counter behavior at limits and gate start					
Reaction to violation of a counting limit	Continue counting	Reset when counting limit is violated	To opposite counting limit	Reaction to gate start	Continue with current value
High speed counters (HSC)\HSC 4\Channel 0\Behavior of inputs\Behavior of DI0\Function of DI0					
Set function of DI	Digital input without function	HSC DI0	None	Input delay	No input for DI0 selected
High speed counters (HSC)\HSC 4\Channel 0\Behavior of inputs\Behavior of DI1\Function of DI1					
Set function of DI	Digital input without function	HSC DI1	None	Input delay	No input for DI1 selected
High speed counters (HSC)\HSC 4\Channel 0\Behavior of outputs\Behavior of DQ0\Function of DQ0					
Set output	Between comparison value 0 and high limit	Comparison value 0	0	Comparison value 1	10
Count direction	In both directions	Pulse duration	500.0ms	Substitute value for DQ0	0
HSC DQ0	Only available via feedback interface				
High speed counters (HSC)\HSC 4\Channel 0\Behavior of outputs\Behavior of DQ1\Function of DQ1					
Set output	Between comparison value 1 and high limit	Comparison value 0	0	Comparison value 1	10
Count direction	In both directions	Pulse duration	500.0ms	Substitute value for DQ1	0
HSC DQ1	None				
High speed counters (HSC)\HSC 4\Channel 0\Hysteresis\Set hysteresis range					
Hysteresis (in increments)	0				
High speed counters (HSC)\HSC 4\Channel 0\Measured value\Specify measured value					
Measured variable	Frequency	Update time	10.000ms		
High speed counters (HSC)\HSC 4\Hardware inputs/outputs					
Pulse input (A)	X12, Clamp 1 (DI0 / %I12.0)	Direction input (B)	X12, Clamp 2 (DI1 / %I12.1)	Reset input (N)	None
HSC DI0	None	HSC DI1	None	HSC DQ0	Only available via feedback interface
HSC DQ1	None				
High speed counters (HSC)\HSC 4\I/O addresses\Input addresses					
Start address	62.0	End address	77.7	Organization block	0
Process image	0				
High speed counters (HSC)\HSC 4\I/O addresses\Output addresses					
Start address	44.0	End address	55.7	Organization block	0
Process image	0				
High speed counters (HSC)\HSC 5\General\Enable					
Activate this high-speed counter	False				
High speed counters (HSC)\HSC 5\General\Project information					
Name	HSC_5	Author	Mmuhammed	Comment	
High speed counters (HSC)\HSC 5\Channel 0\Operating mode					
Selection of operating mode	Operating with technology object "Counting and measurement"				
High speed counters (HSC)\HSC 5\Channel 0\Reaction to CPU STOP					
Reaction to CPU STOP	Output substitute value	Substitute value for DQ0	0	Substitute value for DQ1	0
High speed counters (HSC)\HSC 5\Channel 0\Diagnostic interrupts					
Enable diagnostic interrupts	False				
High speed counters (HSC)\HSC 5\Channel 0\Hardware interrupts\Hardware interrupt triggered by external events\					
New capture value available	0	RidPrefixCaptureEvent	49280	Event name	
Hardware interrupt	0	Capture value0	Capture value0	Channel number	0
HwEventTypeCapture	8				
High speed counters (HSC)\HSC 5\Channel 0\Hardware interrupts\Hardware interrupt triggered by external events\					
Synchronization of the counter by an external signal	0	RidPrefixSyncEvent	49296	Event name	
Hardware interrupt	0	Synchronization0	Synchronization0	Channel number	0
HwEventTypeSync	9				
High speed counters (HSC)\HSC 5\Channel 0\Hardware interrupts\Hardware interrupt triggered by external events\					
Gate start	0	RidPrefixGateStartEvent	49168	Event name	
Hardware interrupt	0	Gate start0	Gate start0	Channel number	0
HwEventTypeGateStart	1				
High speed counters (HSC)\HSC 5\Channel 0\Hardware interrupts\Hardware interrupt triggered by external events\					
Gate stop	0	RidPrefixGateStopEvent	49184	Event name	
Hardware interrupt	0	Gate stop0	Gate stop0	Channel number	0
HwEventTypeGateStop	2				

Instrumentation Tools

Totally Integrated Automation Portal					
High speed counters (HSC)\HSC 5\Channel 0\Hardware interrupts\Hardware interrupt by counter value/position value\					
Overflow (high counting limit violated)	0	RidPrefixOverflowEvent	49200	Event name	
Hardware interrupt	0	Overflow0	Overflow0	Channel number	0
HwEventTypeOverflow	3				
High speed counters (HSC)\HSC 5\Channel 0\Hardware interrupts\Hardware interrupt by counter value/position value\					
Underflow (low counting limit violated)	0	RidPrefixUnderflowEvent	49216	Event name	
Hardware interrupt	0	Underflow0	Underflow0	Channel number	0
HwEventTypeUnderflow	4				
High speed counters (HSC)\HSC 5\Channel 0\Hardware interrupts\Hardware interrupt by counter value/position value\					
Direction reversal	0	RidPrefixDirectionChangedEvent	49312	Event name	
Hardware interrupt	0	Direction reversal0	Direction reversal0	Channel number	0
HwEventTypeDirectionChanged	10				
High speed counters (HSC)\HSC 5\Channel 0\Hardware interrupts\Hardware interrupt by counter value/position value\					
Zero crossing	0	RidPrefixZeroCrossingEvent	49264	Event name	
Hardware interrupt	0	Zero crossing0	Zero crossing0	Channel number	0
HwEventTypeZeroCrossing	7				
High speed counters (HSC)\HSC 5\Channel 0\Hardware interrupts\Hardware interrupt by counter value/position value\					
Comparison event for DQ0 occurred	0	RidPrefixCompare0Event	49232	Event name	
Hardware interrupt	0	Compare event DQ00	Compare event DQ00	Channel number	0
HwEventTypeCompare0	5				
High speed counters (HSC)\HSC 5\Channel 0\Hardware interrupts\Hardware interrupt by counter value/position value\					
Comparison event for DQ1 occurred	0	RidPrefixCompare1Event	49248	Event name	
Hardware interrupt	0	Compare event DQ10	Compare event DQ10	Channel number	0
HwEventTypeCompare1	6				
High speed counters (HSC)\HSC 5\Channel 0\Counter inputs\Specify input signals/encoder type					
Signal type	Pulse (A) and direction (B)		Invert direction	False	
High speed counters (HSC)\HSC 5\Channel 0\Counter inputs\Additional parameters					
Signal evaluation	Single	Filter frequency	100 kHz	Reaction to signal N	No reaction to signal N
High speed counters (HSC)\HSC 5\Channel 0\Counter behavior\Counting limits and start value					
High counting limit	2147483647	Start value	0	Low counting limit	-2147483648
High speed counters (HSC)\HSC 5\Channel 0\Counter behavior\Counter behavior at limits and gate start					
Reaction to violation of a counting limit	Continue counting	Reset when counting limit is violated	To opposite counting limit	Reaction to gate start	Continue with current value
High speed counters (HSC)\HSC 5\Channel 0\Behavior of inputs\Behavior of DI0\Function of DI0					
Set function of DI	Digital input without function	HSC DI0	None	Input delay	No input for DI0 selected
High speed counters (HSC)\HSC 5\Channel 0\Behavior of inputs\Behavior of DI1\Function of DI1					
Set function of DI	Digital input without function	HSC DI1	None	Input delay	No input for DI1 selected
High speed counters (HSC)\HSC 5\Channel 0\Behavior of outputs\Behavior of DQ0\Function of DQ0					
Set output	Between comparison value 0 and high limit	Comparison value 0	0	Comparison value 1	10
Count direction	In both directions	Pulse duration	500.0ms	Substitute value for DQ0	0
HSC DQ0	Only available via feedback interface				
High speed counters (HSC)\HSC 5\Channel 0\Behavior of outputs\Behavior of DQ1\Function of DQ1					
Set output	Between comparison value 1 and high limit	Comparison value 0	0	Comparison value 1	10
Count direction	In both directions	Pulse duration	500.0ms	Substitute value for DQ1	0
HSC DQ1	None				
High speed counters (HSC)\HSC 5\Channel 0\Hysteresis\Set hysteresis range					
Hysteresis (in increments)	0				
High speed counters (HSC)\HSC 5\Channel 0\Measured value\Specify measured value					
Measured variable	Frequency	Update time	10.000ms		
High speed counters (HSC)\HSC 5\Hardware inputs/outputs					
Pulse input (A)	X12, Clamp 4 (DI3 / %I12.3)	Direction input (B)	X12, Clamp 5 (DI4 / %I12.4)	Reset input (N)	None
HSC DI0	None	HSC DI1	None	HSC DQ0	Only available via feedback interface
HSC DQ1	None				
High speed counters (HSC)\HSC 5\I/O addresses\Input addresses					
Start address	78.0	End address	93.7	Organization block	0
Process image	0				
High speed counters (HSC)\HSC 5\I/O addresses\Output addresses					
Start address	56.0	End address	67.7	Organization block	0
Process image	0				
High speed counters (HSC)\HSC 6\General\Enable					
Activate this high-speed counter	False				
High speed counters (HSC)\HSC 6\General\Project information					
Name	HSC_6	Author	Mmuhammed	Comment	
High speed counters (HSC)\HSC 6\Channel 0\Operating mode					
Selection of operating mode	Operating with technology object "Counting and measurement"				
High speed counters (HSC)\HSC 6\Channel 0\Reaction to CPU STOP					
Reaction to CPU STOP	Output substitute value	Substitute value for DQ0	0	Substitute value for DQ1	0

Instrumentation Tools

Totally Integrated Automation Portal					
High speed counters (HSC)\HSC 6\Channel 0\Diagnostic interrupts					
Enable diagnostic interrupts	False				
High speed counters (HSC)\HSC 6\Channel 0\Hardware interrupts\Hardware interrupt triggered by external events\					
New capture value available	0	RidPrefixCaptureEvent	49280	Event name	
Hardware interrupt	0	Capture value0	Capture value0	Channel number	0
HwEventTypeCapture	8				
High speed counters (HSC)\HSC 6\Channel 0\Hardware interrupts\Hardware interrupt triggered by external events\					
Synchronization of the counter by an external signal	0	RidPrefixSyncEvent	49296	Event name	
Hardware interrupt	0	Synchronization0	Synchronization0	Channel number	0
HwEventTypeSync	9				
High speed counters (HSC)\HSC 6\Channel 0\Hardware interrupts\Hardware interrupt triggered by external events\					
Gate start	0	RidPrefixGateStartEvent	49168	Event name	
Hardware interrupt	0	Gate start0	Gate start0	Channel number	0
HwEventTypeGateStart	1				
High speed counters (HSC)\HSC 6\Channel 0\Hardware interrupts\Hardware interrupt triggered by external events\					
Gate stop	0	RidPrefixGateStopEvent	49184	Event name	
Hardware interrupt	0	Gate stop0	Gate stop0	Channel number	0
HwEventTypeGateStop	2				
High speed counters (HSC)\HSC 6\Channel 0\Hardware interrupts\Hardware interrupt by counter value/position value\					
Overflow (high counting limit violated)	0	RidPrefixOverflowEvent	49200	Event name	
Hardware interrupt	0	Overflow0	Overflow0	Channel number	0
HwEventTypeOverflow	3				
High speed counters (HSC)\HSC 6\Channel 0\Hardware interrupts\Hardware interrupt by counter value/position value\					
Underflow (low counting limit violated)	0	RidPrefixUnderflowEvent	49216	Event name	
Hardware interrupt	0	Underflow0	Underflow0	Channel number	0
HwEventTypeUnderflow	4				
High speed counters (HSC)\HSC 6\Channel 0\Hardware interrupts\Hardware interrupt by counter value/position value\					
Direction reversal	0	RidPrefixDirectionChangedEvent	49312	Event name	
Hardware interrupt	0	Direction reversal0	Direction reversal0	Channel number	0
HwEventTypeDirectionChanged	10				
High speed counters (HSC)\HSC 6\Channel 0\Hardware interrupts\Hardware interrupt by counter value/position value\					
Zero crossing	0	RidPrefixZeroCrossingEvent	49264	Event name	
Hardware interrupt	0	Zero crossing0	Zero crossing0	Channel number	0
HwEventTypeZeroCrossing	7				
High speed counters (HSC)\HSC 6\Channel 0\Hardware interrupts\Hardware interrupt by counter value/position value\					
Comparison event for DQ0 occurred	0	RidPrefixCompare0Event	49232	Event name	
Hardware interrupt	0	Compare event DQ00	Compare event DQ00	Channel number	0
HwEventTypeCompare0	5				
High speed counters (HSC)\HSC 6\Channel 0\Hardware interrupts\Hardware interrupt by counter value/position value\					
Comparison event for DQ1 occurred	0	RidPrefixCompare1Event	49248	Event name	
Hardware interrupt	0	Compare event DQ10	Compare event DQ10	Channel number	0
HwEventTypeCompare1	6				
High speed counters (HSC)\HSC 6\Channel 0\Counter inputs\Specify input signals/encoder type					
Signal type	Pulse (A) and direction (B)	Invert direction	False		
High speed counters (HSC)\HSC 6\Channel 0\Counter inputs\Additional parameters					
Signal evaluation	Single	Filter frequency	100 kHz	Reaction to signal N	No reaction to signal N
High speed counters (HSC)\HSC 6\Channel 0\Counter behavior\Counting limits and start value					
High counting limit	2147483647	Start value	0	Low counting limit	-2147483648
High speed counters (HSC)\HSC 6\Channel 0\Counter behavior\Counter behavior at limits and gate start					
Reaction to violation of a counting limit	Continue counting	Reset when counting limit is violated	To opposite counting limit	Reaction to gate start	Continue with current value
High speed counters (HSC)\HSC 6\Channel 0\Behavior of inputs\Behavior of DI0\Function of DI0					
Set function of DI	Digital input without function	HSC DI0	None	Input delay	No input for DI0 selected
High speed counters (HSC)\HSC 6\Channel 0\Behavior of inputs\Behavior of DI1\Function of DI1					
Set function of DI	Digital input without function	HSC DI1	None	Input delay	No input for DI1 selected
High speed counters (HSC)\HSC 6\Channel 0\Behavior of outputs\Behavior of DQ0\Function of DQ0					
Set output	Between comparison value 0 and high limit	Comparison value 0	0	Comparison value 1	10
Count direction	In both directions	Pulse duration	500.0ms	Substitute value for DQ0	0
HSC DQ0	Only available via feedback interface				
High speed counters (HSC)\HSC 6\Channel 0\Behavior of outputs\Behavior of DQ1\Function of DQ1					
Set output	Between comparison value 1 and high limit	Comparison value 0	0	Comparison value 1	10
Count direction	In both directions	Pulse duration	500.0ms	Substitute value for DQ1	0
HSC DQ1	None				

Instrumentation Tools

Totally Integrated Automation Portal					
High speed counters (HSC)\HSC 6\Channel 0\Hysteresis\Set hysteresis range					
Hysteresis (in increments)	0				
High speed counters (HSC)\HSC 6\Channel 0\Measured value\Specify measured value					
Measured variable	Frequency	Update time	10.000ms		
High speed counters (HSC)\HSC 6\Hardware inputs/outputs					
Pulse input (A)	X12, Clamp 7 (DI6 / %I12.6)	Direction input (B)	X12, Clamp 8 (DI7 / %I12.7)	Reset input (N)	None
HSC DI0	None	HSC DI1	None	HSC DQ0	Only available via feedback interface
HSC DQ1	None				
High speed counters (HSC)\HSC 6\I/O addresses\Input addresses					
Start address	94.0	End address	109.7	Organization block	0
Process image	0				
High speed counters (HSC)\HSC 6\I/O addresses\Output addresses					
Start address	68.0	End address	79.7	Organization block	0
Process image	0				
Pulse generators (PTO/PWM)\CPU 1511C compatibility					
Front connector assignment like CPU 1511C	False				
Pulse generators (PTO/PWM)\PTO1/PWM1\General\Project information					
Name	Pulse_1	Comment			
Pulse generators (PTO/PWM)\PTO1/PWM1\General\Operating mode					
Operating mode	Deactivated				
Pulse generators (PTO/PWM)\PTO1/PWM1\Reaction to CPU STOP					
Reaction to CPU STOP	Output substitute value	Substitute value for pulse output (DQA)	0		
Pulse generators (PTO/PWM)\PTO1/PWM1\Diagnostic interrupts					
No supply voltage L+	False				
Pulse generators (PTO/PWM)\PTO1/PWM1\Hardware inputs/outputs					
Pulse output (DQA)	X11, Clamp 21 (DQ0 / %Q4.0): 10 kHz / 0.5 A or 100 kHz / 0.1 A	High-speed output (0.1 A)	False		
Pulse generators (PTO/PWM)\PTO1/PWM1\Parameters					
Output format	Per 100				
Pulse generators (PTO/PWM)\PTO1/PWM1\I/O addresses\Input addresses					
Start address	110.0	End address	113.7	Organization block	0
Process image	0				
Pulse generators (PTO/PWM)\PTO1/PWM1\I/O addresses\Output addresses					
Start address	80.0	End address	91.7	Organization block	0
Process image	0				
Pulse generators (PTO/PWM)\PTO2/PWM2\General\Project information					
Name	Pulse_2	Comment			
Pulse generators (PTO/PWM)\PTO2/PWM2\General\Operating mode					
Operating mode	Deactivated				
Pulse generators (PTO/PWM)\PTO2/PWM2\Reaction to CPU STOP					
Reaction to CPU STOP	Output substitute value	Substitute value for pulse output (DQA)	0		
Pulse generators (PTO/PWM)\PTO2/PWM2\Diagnostic interrupts					
No supply voltage L+	False				
Pulse generators (PTO/PWM)\PTO2/PWM2\Hardware inputs/outputs					
Pulse output (DQA)	X11, Clamp 23 (DQ2 / %Q4.2): 10 kHz / 0.5 A or 100 kHz / 0.1 A	High-speed output (0.1 A)	False		
Pulse generators (PTO/PWM)\PTO2/PWM2\Parameters					
Output format	Per 100				
Pulse generators (PTO/PWM)\PTO2/PWM2\I/O addresses\Input addresses					
Start address	114.0	End address	117.7	Organization block	0
Process image	0				
Pulse generators (PTO/PWM)\PTO2/PWM2\I/O addresses\Output addresses					
Start address	92.0	End address	103.7	Organization block	0
Process image	0				
Pulse generators (PTO/PWM)\PTO3/PWM3\General\Project information					
Name	Pulse_3	Comment			
Pulse generators (PTO/PWM)\PTO3/PWM3\General\Operating mode					
Operating mode	Deactivated				
Pulse generators (PTO/PWM)\PTO3/PWM3\Reaction to CPU STOP					
Reaction to CPU STOP	Output substitute value	Substitute value for pulse output (DQA)	0		
Pulse generators (PTO/PWM)\PTO3/PWM3\Diagnostic interrupts					
No supply voltage L+	False				
Pulse generators (PTO/PWM)\PTO3/PWM3\Hardware inputs/outputs					
Pulse output (DQA)	X11, Clamp 25 (DQ4 / %Q4.4): 10 kHz / 0.5 A or 100 kHz / 0.1 A	High-speed output (0.1 A)	False		
Pulse generators (PTO/PWM)\PTO3/PWM3\Parameters					
Output format	Per 100				
Pulse generators (PTO/PWM)\PTO3/PWM3\I/O addresses\Input addresses					
Start address	118.0	End address	121.7	Organization block	0
Process image	0				
Pulse generators (PTO/PWM)\PTO3/PWM3\I/O addresses\Output addresses					
Start address	104.0	End address	115.7	Organization block	0
Process image	0				
Pulse generators (PTO/PWM)\PTO4/PWM4\General\Project information					
Name	Pulse_4	Comment			
Pulse generators (PTO/PWM)\PTO4/PWM4\General\Operating mode					
Operating mode	Deactivated				
Pulse generators (PTO/PWM)\PTO4/PWM4\Reaction to CPU STOP					
Reaction to CPU STOP	Output substitute value	Substitute value for pulse output (DQA)	0		

Instrumentation Tools

Totally Integrated Automation Portal						
Pulse generators (PTO/PWM)\PTO4/PWM4\Diagnostic interrupts						
No supply voltage L+	False					
Pulse generators (PTO/PWM)\PTO4/PWM4\Hardware inputs/outputs						
Pulse output (DQA)	X11, Clamp 27 (DQ6 / %Q4.6): 10 kHz / 0.5 A or 100 kHz / 0.1 A	High-speed output (0.1 A)	False			
Pulse generators (PTO/PWM)\PTO4/PWM4\Parameters						
Output format	Per 100					
Pulse generators (PTO/PWM)\PTO4/PWM4\I/O addresses\Input addresses						
Start address	122.0	End address	125.7	Organization block	0	
Process image	0					
Pulse generators (PTO/PWM)\PTO4/PWM4\I/O addresses\Output addresses						
Start address	116.0	End address	127.7	Organization block	0	
Process image	0					
Startup						
Startup after POWER ON	Warm restart - Operating mode before POWER OFF	Comparison preset to actual configuration	Startup CPU even if mismatch	Configuration time	60000ms	
Cycle						
Maximum cycle time	150ms			Enable minimum cycle time for cyclic OBs	True	
Minimum cycle time	1ms					
Communication load						
Cycle load due to communication	50%					
System and clock memory\System memory bits						
Enable the use of system memory byte	False	Address of system memory byte (MBx)	1	First cycle		
Diagnostic status changed		Always 1 (high)		Always 0 (low)		
System and clock memory\Clock memory bits						
Enable the use of clock memory byte	False	Address of clock memory byte (MBx)	0	10 Hz clock		
5 Hz clock		2.5 Hz clock		2 Hz clock		
1.25 Hz clock		1 Hz clock		0.625 Hz clock		
0.5 Hz clock						
SIMATIC Memory Card\Diagnostics						
Aging of the SIMATIC memory card	False	Threshold value	80%			
System diagnostics\General						
Activate system diagnostics for this device	True	Report network faults as maintenance instead of fault	False			
PLC alarms\General						
Central alarm management in the PLC	True					
Web server\General						
Activate web server on this module	False	Permit access only with HTTPS	True			
Web server\Automatic update						
Enable automatic update	True	Update interval	0s			
Web server\User management						
User name			User rights			
Everybody						
Web server\User-defined web pages						
Application name	HTML source path	Default HTML page	Files with dynamic content	Web DB number	Fragment DB number	
		index.htm	.htm;.html	333	334	
Web server\Overview of interfaces						
Device	Interface			Enabled web server access		
PLC_1	PROFINET interface_1			False		
DNS configuration						
No DNS server address is configured.						
Display\General\Display standby mode						
Time to standby mode	30 minutes					
Display\General\Energy saving mode						
Time to energy saving mode	15 minutes					
Display\General\Display language						
Default language on display	English					
Display\Automatic update						
Time to update	5 seconds					
Display>Password\Display protection						
Enable write access	True	Enable display protection	False			
Display\User-defined logo						
User logo activated	False	Adapt logo	False	Resolution	128x120	
Company logo	---					

Instrumentation Tools

Totally Integrated Automation Portal				
User interface languages				
Assign project language		User interface languages		
English (United States)		German		
English (United States)		English		
English (United States)		French		
English (United States)		Spanish		
English (United States)		Italian		
English (United States)		Japanese		
English (United States)		Chinese (simplified)		
English (United States)		Korean		
English (United States)		Russian		
English (United States)		Turkish		
English (United States)		Portuguese (Brazil)		
Time of day\Local time				
Time zone	(UTC) Dublin, Edinburgh, Lisbon, London			
Time of day\Daylight saving time				
Activate daylight saving time	True	Difference between standard and daylight saving time	60 mins	
Time of day\Daylight saving time\Start of daylight saving time				
Selection of the week	Last	Selection of the weekday	Sunday	of March
at	01:00 a.m.			
Time of day\Daylight saving time\Start of standard time				
Selection of the week	Last	Selection of the weekday	Sunday	of October
at	02:00 a.m.			
Protection				
Level of protection	Full access (no protection)			
Protection\Connection mechanisms				
Permit access with PUT/GET communication from remote partner	False			
Protection\Security event				
Summarize security events in case of high message volume	True	Length of an interval	20	Unit seconds
OPC UA\Accessibility of the server				
Activate OPC UA server	False			
System power supply\General				
General	Connection to supply voltage L+			
System power supply\Power segment overview				
Module	Slot	Supply/consumption		
PLC_1	1	10.00W		
	Summary	10.00W		
Configuration control\Configuration control for central configuration				
Allow reconfiguration of device via the user program	False			
Connection resources\				
	Station resources - Reserved - Maximum	Station resources - Reserved - Configured	Station resources - Dynamic - Configured	Module resources - PLC_1 [CPU 1512C-1 PN] - Configured
Maximum number of resources:		10	78	88
	Maximum	Configured	Configured	Configured
PG communication:	4	-	-	-
HMI communication:	4	2	0	2
S7 communication:	0	-	0	0
Open user communication:	0	-	0	0
Web communication:	2	-	-	-
OPC UA client/server communication:	0	-	-	-
Other communication:	-	-	0	0
Total resources used:		2	0	2
Available resources:		8	78	86
Overview of addresses\Overview of addresses\Overview of addresses				
Inputs	True	Outputs	True	Address gaps False
Slot	True			

Instrumentation Tools

Totally Integrated Automation Portal											
Type	Addr. from	Addr. to	Module	PIP	OB	Device name	Device number	Size	Master / IO system	Rack	Slot
I	0	9	AI 5/AQ 2_1	Automatic update	-	PLC_1 [CPU 1512C-1 PN]	-	10 Bytes	-	0	1 8
O	0	3	AI 5/AQ 2_1	Automatic update	-	PLC_1 [CPU 1512C-1 PN]	-	4 Bytes	-	0	1 8
I	10	11	DI 16/DQ 16_1	Automatic update	-	PLC_1 [CPU 1512C-1 PN]	-	2 Bytes	-	0	1 9
O	4	5	DI 16/DQ 16_1	Automatic update	-	PLC_1 [CPU 1512C-1 PN]	-	2 Bytes	-	0	1 9
I	12	13	DI 16/DQ 16_2	Automatic update	-	PLC_1 [CPU 1512C-1 PN]	-	2 Bytes	-	0	1 10
O	6	7	DI 16/DQ 16_2	Automatic update	-	PLC_1 [CPU 1512C-1 PN]	-	2 Bytes	-	0	1 10
I	14	29	HSC_1	Automatic update	-	PLC_1 [CPU 1512C-1 PN]	-	16 Bytes	-	0	1 16
O	8	19	HSC_1	Automatic update	-	PLC_1 [CPU 1512C-1 PN]	-	12 Bytes	-	0	1 16
I	30	45	HSC_2	Automatic update	-	PLC_1 [CPU 1512C-1 PN]	-	16 Bytes	-	0	1 17
O	20	31	HSC_2	Automatic update	-	PLC_1 [CPU 1512C-1 PN]	-	12 Bytes	-	0	1 17
I	46	61	HSC_3	Automatic update	-	PLC_1 [CPU 1512C-1 PN]	-	16 Bytes	-	0	1 18
O	32	43	HSC_3	Automatic update	-	PLC_1 [CPU 1512C-1 PN]	-	12 Bytes	-	0	1 18
I	62	77	HSC_4	Automatic update	-	PLC_1 [CPU 1512C-1 PN]	-	16 Bytes	-	0	1 19
O	44	55	HSC_4	Automatic update	-	PLC_1 [CPU 1512C-1 PN]	-	12 Bytes	-	0	1 19
I	78	93	HSC_5	Automatic update	-	PLC_1 [CPU 1512C-1 PN]	-	16 Bytes	-	0	1 20
O	56	67	HSC_5	Automatic update	-	PLC_1 [CPU 1512C-1 PN]	-	12 Bytes	-	0	1 20
I	94	109	HSC_6	Automatic update	-	PLC_1 [CPU 1512C-1 PN]	-	16 Bytes	-	0	1 21
O	68	79	HSC_6	Automatic update	-	PLC_1 [CPU 1512C-1 PN]	-	12 Bytes	-	0	1 21
I	110	113	Pulse_1	Automatic update	-	PLC_1 [CPU 1512C-1 PN]	-	4 Bytes	-	0	1 32
O	80	91	Pulse_1	Automatic update	-	PLC_1 [CPU 1512C-1 PN]	-	12 Bytes	-	0	1 32
I	114	117	Pulse_2	Automatic update	-	PLC_1 [CPU 1512C-1 PN]	-	4 Bytes	-	0	1 33
O	92	103	Pulse_2	Automatic update	-	PLC_1 [CPU 1512C-1 PN]	-	12 Bytes	-	0	1 33
I	118	121	Pulse_3	Automatic update	-	PLC_1 [CPU 1512C-1 PN]	-	4 Bytes	-	0	1 34
O	104	115	Pulse_3	Automatic update	-	PLC_1 [CPU 1512C-1 PN]	-	12 Bytes	-	0	1 34
I	122	125	Pulse_4	Automatic update	-	PLC_1 [CPU 1512C-1 PN]	-	4 Bytes	-	0	1 35
O	116	127	Pulse_4	Automatic update	-	PLC_1 [CPU 1512C-1 PN]	-	12 Bytes	-	0	1 35
Runtime licenses\OPC UA\Runtime licenses											
Type of required license	None		Type of purchased license	No license							
Runtime licenses\ProDiag\Supervisions											
Number of used supervisions	0										
Runtime licenses\ProDiag\Runtime licenses											
Number of required licenses	None (<= 25 supervisions)		Used ProDiag licenses	No license							
Runtime licenses\Energy Suite\Energy objects											
Number of configured energy objects	0										
Runtime licenses\Energy Suite\Runtime licenses											
Total number of licensed energy objects	0										
Runtime licenses\Energy Suite\Runtime licenses\Number of purchased licenses											
License type '5 energy objects'	No license		License type '10 energy objects'	No license							

PID_PWM and PID_Output / PLC_1 [CPU 1512C-1 PN]

Software units

This folder is empty.

PID_PWM and PID_Output / PLC_1 [CPU 1512C-1 PN] / Program blocks

Main [OB1]

Main Properties

General

Name	Main	Number	1	Type	OB	Language	LAD
------	------	--------	---	------	----	----------	-----

Numbering	Automatic
-----------	-----------

Information

Title	"Main Program Sweep (Cycle)"	Author		Comment		Family	
-------	------------------------------	--------	--	---------	--	--------	--

Version	0.1	User-defined ID	
---------	-----	-----------------	--

Name	Data type	Default value	Comment
▼ Input			
Initial_Call	Bool		Initial call of this OB
Remanence	Bool		=True, if remanent data are available
Temp			
Constant			

Network 1: simulation of TANK1 analog input of the level sensor to the PLC

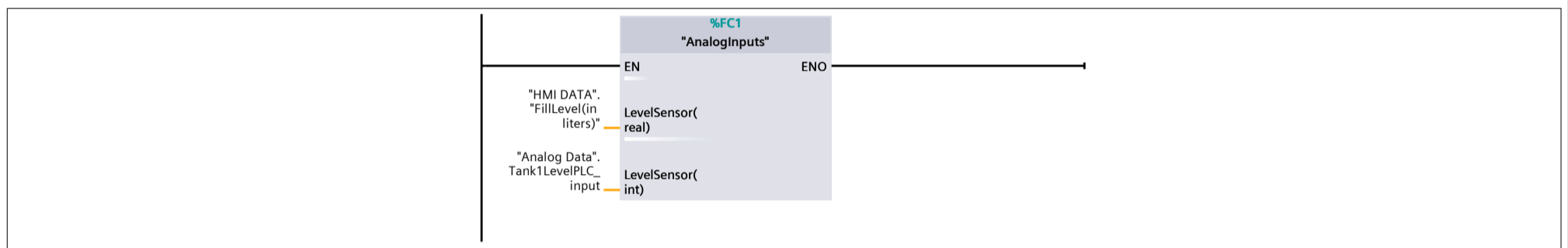

Network 2: simulation of TANK2 analog input of the level sensor to the PLC

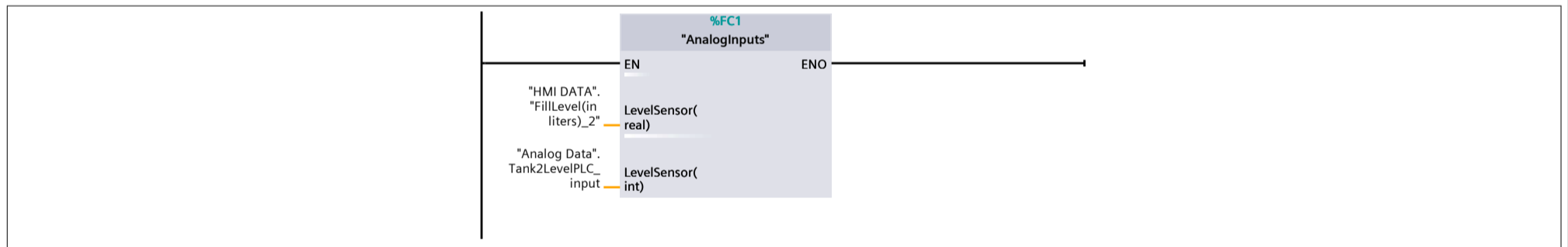

Network 3: Simulation of the behaviour of the pump of 0-10 liters/sec in corresponding to 0-10v PLC output

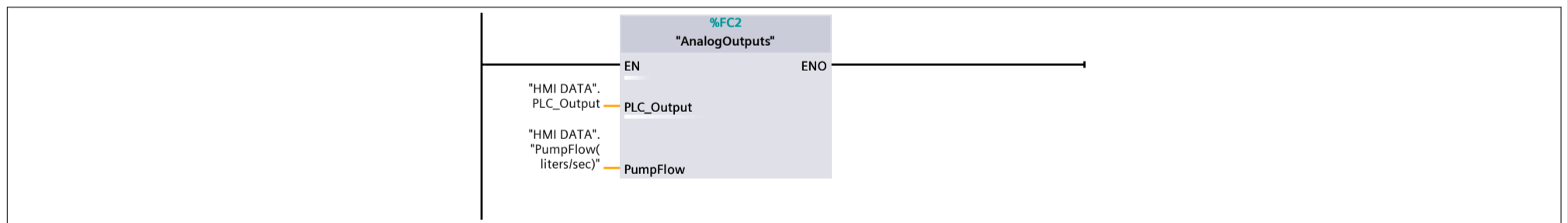

Network 4: SIMULATION OF THE TANK2 pump output corresponding to the ON/OFF behavior of the PID_PWM

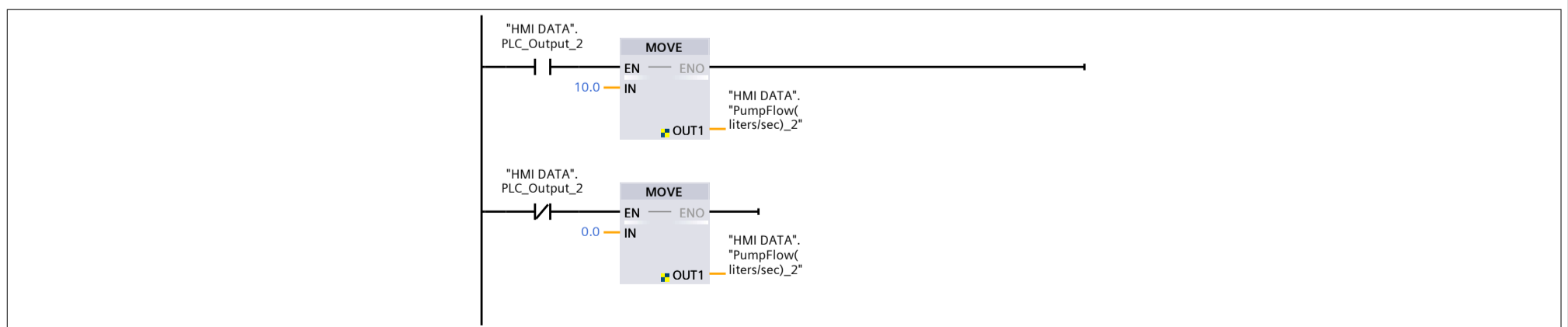

Network 5: empty tank and PID integral sum

Instrumentation Tools

Totally Integrated
Automation Portal

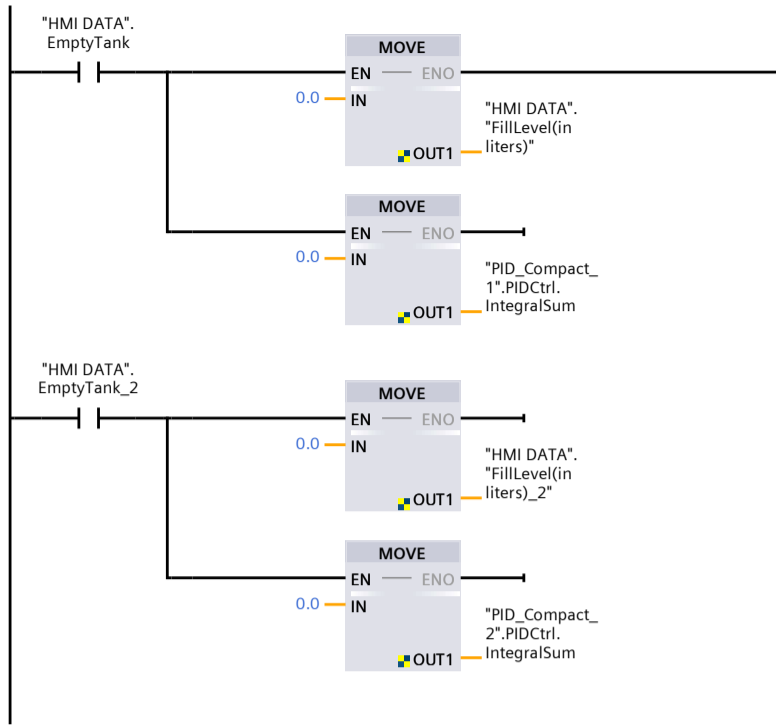

PID_PWM and PID_Output / PLC_1 [CPU 1512C-1 PN] / Program blocks

Analog Data [DB1]

Analog Data Properties

General

Name	Analog Data	Number	1	Type	DB	Language	DB
-------------	-------------	---------------	---	-------------	----	-----------------	----

Numbering	Automatic
------------------	-----------

Information

Title		Author		Comment		Family	
--------------	--	---------------	--	----------------	--	---------------	--

Version	0.1	User-defined ID	
----------------	-----	------------------------	--

Name	Data type	Start value	Retain	Accessible from HMI/OPC UA/Web API	Writ-able from HMI/ OPC UA/ Web API	Visible in HMI engi-neering	Setpoint	Supervi-sion	Comment
▼ Static									
Tank1LevelPLC_input	Int	0	False	True	True	True	False		
Tank2LevelPLC_input	Int	0	False	True	True	True	False		

PID_PWM and PID_Output / PLC_1 [CPU 1512C-1 PN] / Program blocks

AnalogInputs [FC1]

AnalogInputs Properties

General

Name	AnalogInputs	Number	1	Type	FC	Language	LAD
-------------	--------------	---------------	---	-------------	----	-----------------	-----

Numbering	Automatic
------------------	-----------

Information

Title		Author		Comment	this block will simulate the existance of a real level sensor. we don't acutally have a real level sensor, so we will simulate this sensor as fo- low	Family	
--------------	--	---------------	--	----------------	---	---------------	--

Version	0.1	User-defined ID	
----------------	-----	------------------------	--

Name	Data type	Default value	Comment
▼ Input			
LevelSensor(real)	Real		
Output			
▼ InOut			
LevelSensor(int)	Int		
▼ Temp			
calculation1	Real		
calculation2	Real		
LevelSensor(V)	Real		
Constant			
▼ Return			
AnalogInputs	Void		

Network 1:

A level sensor will convert a 0-50liters level measurements into a 0-10 V signal. which then goes into the PLC Input module

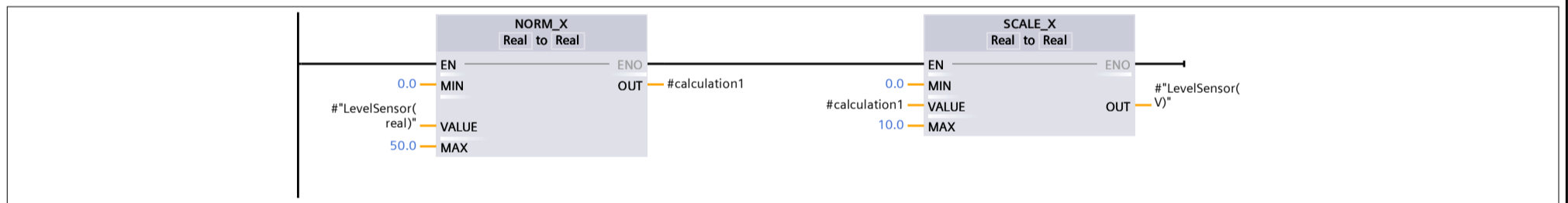

Network 2:

the 0-10V readings at the input module will be converted to the 0-50 liters measurements of the sensor

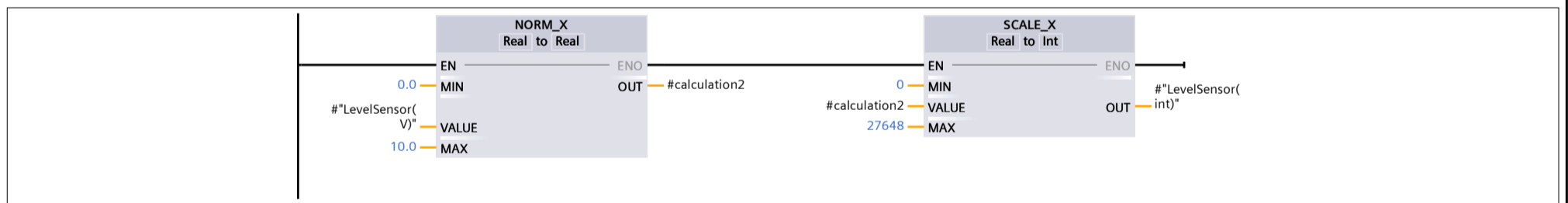

PID_PWM and PID_Output / PLC_1 [CPU 1512C-1 PN] / Program blocks

AnalogOutputs [FC2]

AnalogOutputs Properties

General

Name	AnalogOutputs	Number	2	Type	FC	Language	LAD
-------------	---------------	---------------	---	-------------	----	-----------------	-----

Numbering	Automatic
------------------	-----------

Information

Title		Author		Comment		Family	
--------------	--	---------------	--	----------------	--	---------------	--

Version	0.1	User-defined ID	
----------------	-----	------------------------	--

Name	Data type	Default value	Comment
▼ Input			
PLC_Output	Int		
Output			
▼ InOut			
PumpFlow	Real		
▼ Temp			
calculation1	Real		
calculation2	Real		
PumpOut	Real		
Constant			
▼ Return			
AnalogOutputs	Void		

Network 1:

PLC output module will take the output value 0-32767 and convert it to analog range of 0-10V

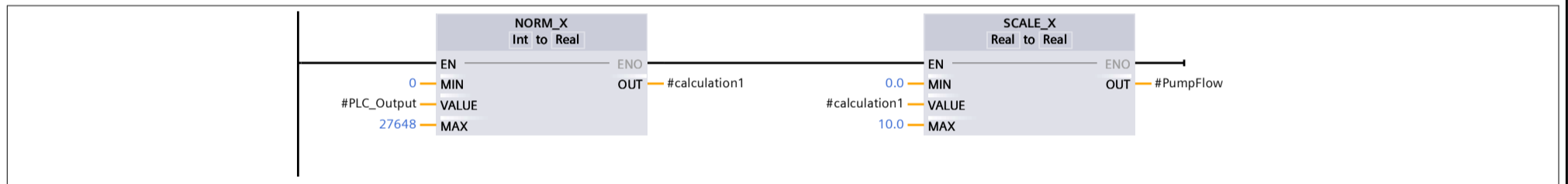

Instrumentation Tools

Totally Integrated Automation Portal

PID_PWM and PID_Output / PLC_1 [CPU 1512C-1 PN] / Program blocks

Tank Simulator [FB2]

Tank Simulator Properties

General

Name	Tank Simulator	Number	2	Type	FB	Language	LAD
Numbering	Automatic						

Information

Title		Author		Comment		Family	
Version	0.1	User-defined ID					

Name	Data type	Default value	Retain	Accessible from HMI/OPC UA/Web API	Writable from HMI/OPC UA/Web API	Visible in HMI engineering	Setpoint	Supervision	Comment
▼ Input									
OutflowDisturbance %/ms	Real	0.0	Non-retain	True	True	True	False		
RandomDisturbance (1-4)	Int	0	Non-retain	True	True	True	False		
PumpFlow (liters/sec)	Real	0.0	Non-retain	True	True	True	False		
Output									
▼ InOut									
FillLevel	Real	0.0	Non-retain	True	True	True	False		
IdleTime(ms)	Int	0	Non-retain	True	True	True	False		
Setpoint(liters)	Real	0.0	Non-retain	True	True	True	False		
▼ Static									
Pump Output real (l/ms)	Real	0.0	Non-retain	True	True	True	False		
▼ Pump Memory	Array[0..9999] of Real		Non-retain	True	True	True	False		
Pump Memory[0]	Real	0.0	Non-retain	True	True	True	False		
Pump Memory[1]	Real	0.0	Non-retain	True	True	True	False		
Pump Memory[2]	Real	0.0	Non-retain	True	True	True	False		
Pump Memory[3]	Real	0.0	Non-retain	True	True	True	False		
Pump Memory[4]	Real	0.0	Non-retain	True	True	True	False		
Pump Memory[5]	Real	0.0	Non-retain	True	True	True	False		
Pump Memory[6]	Real	0.0	Non-retain	True	True	True	False		
Pump Memory[7]	Real	0.0	Non-retain	True	True	True	False		
Pump Memory[8]	Real	0.0	Non-retain	True	True	True	False		
Pump Memory[9]	Real	0.0	Non-retain	True	True	True	False		
Pump Memory[10]	Real	0.0	Non-retain	True	True	True	False		
Pump Memory[11]	Real	0.0	Non-retain	True	True	True	False		
Pump Memory[12]	Real	0.0	Non-retain	True	True	True	False		
Pump Memory[13]	Real	0.0	Non-retain	True	True	True	False		
Pump Memory[14]	Real	0.0	Non-retain	True	True	True	False		
Pump Memory[15]	Real	0.0	Non-retain	True	True	True	False		
Pump Memory[16]	Real	0.0	Non-retain	True	True	True	False		
Pump Memory[17]	Real	0.0	Non-retain	True	True	True	False		
Pump Memory[18]	Real	0.0	Non-retain	True	True	True	False		
Pump Memory[19]	Real	0.0	Non-retain	True	True	True	False		
Pump Memory[20]	Real	0.0	Non-retain	True	True	True	False		
Pump Memory[21]	Real	0.0	Non-retain	True	True	True	False		
Pump Memory[22]	Real	0.0	Non-retain	True	True	True	False		
Pump Memory[23]	Real	0.0	Non-retain	True	True	True	False		
Pump Memory[24]	Real	0.0	Non-retain	True	True	True	False		
Pump Memory[25]	Real	0.0	Non-retain	True	True	True	False		
Pump Memory[26]	Real	0.0	Non-retain	True	True	True	False		
Pump Memory[27]	Real	0.0	Non-retain	True	True	True	False		
Pump Memory[28]	Real	0.0	Non-retain	True	True	True	False		
Pump Memory[29]	Real	0.0	Non-retain	True	True	True	False		
Pump Memory[30]	Real	0.0	Non-retain	True	True	True	False		
Pump Memory[31]	Real	0.0	Non-retain	True	True	True	False		
Pump Memory[32]	Real	0.0	Non-retain	True	True	True	False		
Pump Memory[33]	Real	0.0	Non-retain	True	True	True	False		
Pump Memory[34]	Real	0.0	Non-retain	True	True	True	False		
Pump Memory[35]	Real	0.0	Non-retain	True	True	True	False		
Pump Memory[36]	Real	0.0	Non-retain	True	True	True	False		
Pump Memory[37]	Real	0.0	Non-retain	True	True	True	False		
Pump Memory[38]	Real	0.0	Non-retain	True	True	True	False		
Pump Memory[39]	Real	0.0	Non-retain	True	True	True	False		
Pump Memory[40]	Real	0.0	Non-retain	True	True	True	False		
Pump Memory[41]	Real	0.0	Non-retain	True	True	True	False		
Pump Memory[42]	Real	0.0	Non-retain	True	True	True	False		
Pump Memory[43]	Real	0.0	Non-retain	True	True	True	False		
Pump Memory[44]	Real	0.0	Non-retain	True	True	True	False		
Pump Memory[45]	Real	0.0	Non-retain	True	True	True	False		
Pump Memory[46]	Real	0.0	Non-retain	True	True	True	False		

Instrumentation Tools

Name	Data type	Default value	Retain	Accessible from HMI/OPC UA/Web API	Writ-able from HMI/OPC UA/ Web API	Visible in HMI engi-neering	Setpoint	Supervi-sion	Comment
Pump Memory[9975]	Real	0.0	Non-retain	True	True	True	False		
Pump Memory[9976]	Real	0.0	Non-retain	True	True	True	False		
Pump Memory[9977]	Real	0.0	Non-retain	True	True	True	False		
Pump Memory[9978]	Real	0.0	Non-retain	True	True	True	False		
Pump Memory[9979]	Real	0.0	Non-retain	True	True	True	False		
Pump Memory[9980]	Real	0.0	Non-retain	True	True	True	False		
Pump Memory[9981]	Real	0.0	Non-retain	True	True	True	False		
Pump Memory[9982]	Real	0.0	Non-retain	True	True	True	False		
Pump Memory[9983]	Real	0.0	Non-retain	True	True	True	False		
Pump Memory[9984]	Real	0.0	Non-retain	True	True	True	False		
Pump Memory[9985]	Real	0.0	Non-retain	True	True	True	False		
Pump Memory[9986]	Real	0.0	Non-retain	True	True	True	False		
Pump Memory[9987]	Real	0.0	Non-retain	True	True	True	False		
Pump Memory[9988]	Real	0.0	Non-retain	True	True	True	False		
Pump Memory[9989]	Real	0.0	Non-retain	True	True	True	False		
Pump Memory[9990]	Real	0.0	Non-retain	True	True	True	False		
Pump Memory[9991]	Real	0.0	Non-retain	True	True	True	False		
Pump Memory[9992]	Real	0.0	Non-retain	True	True	True	False		
Pump Memory[9993]	Real	0.0	Non-retain	True	True	True	False		
Pump Memory[9994]	Real	0.0	Non-retain	True	True	True	False		
Pump Memory[9995]	Real	0.0	Non-retain	True	True	True	False		
Pump Memory[9996]	Real	0.0	Non-retain	True	True	True	False		
Pump Memory[9997]	Real	0.0	Non-retain	True	True	True	False		
Pump Memory[9998]	Real	0.0	Non-retain	True	True	True	False		
Pump Memory[9999]	Real	0.0	Non-retain	True	True	True	False		
Pump Memory i	Int	0	Non-retain	True	True	True	False		
Pump Memory Result	Real	0.0	Non-retain	True	True	True	False		
▼ Temp									
Disturbance power	Real								
Random	Int								
SytemTime	DWord								
Constant									

Network 1: setpoint clamping

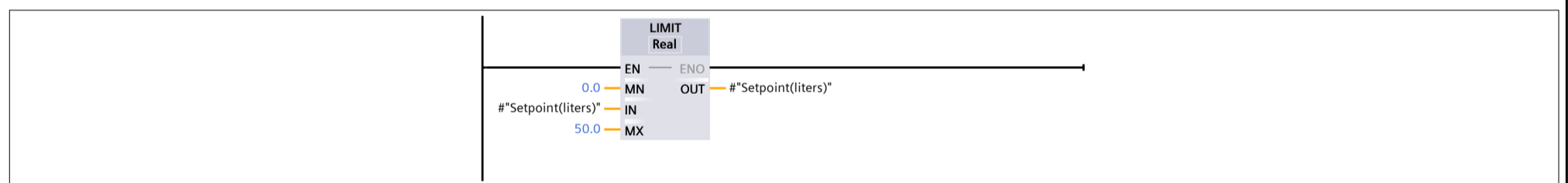

Network 2: Idle time clamping

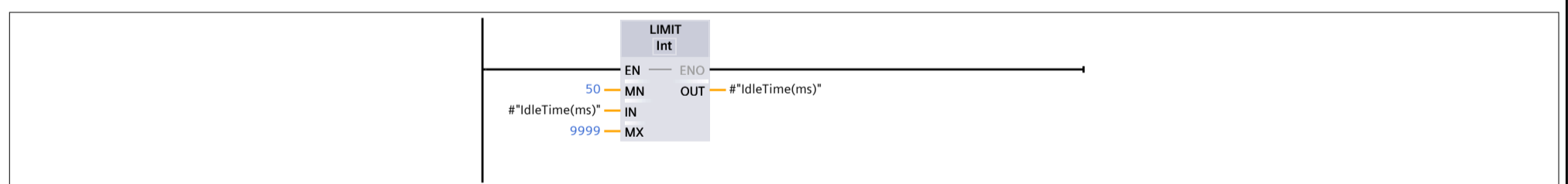

Network 3: pump output memory

This code is collecting and processing pump flow rates and tank status. It calculates the average pump flow rate over a 1ms(which is the calling interval of the cyclic interrupt) interval and resets the data if the tank is empty is activ.

```

0001 #Pump Memory Result" := 0;
0002 FOR #Pump Memory i" := 1 TO #IdleTime (ms)" DO
0003     #Pump Memory"[#Pump Memory i" - 1] := #Pump Memory"[#Pump Memory i"];
0004     #Pump Memory Result" += #Pump Memory"[#Pump Memory i" - 1];
0005 END_FOR;
0006
0007 #Pump Memory"[#IdleTime (ms)"] := #PumpFlow (liters/sec)";
0008 #Pump Memory Result" += #Pump Memory"[#IdleTime (ms)"];
0009 #Pump Memory Result" /= #IdleTime (ms)";
0010
0011
0012 IF "HMI DATA".EmptyTank THEN
0013     FOR #Pump Memory i" := 0 TO #IdleTime (ms)" DO
0014         #Pump Memory"[#Pump Memory i"] := 0;
0015     END_FOR;
0016 END_IF;
    
```

Network 4: Tank level progress

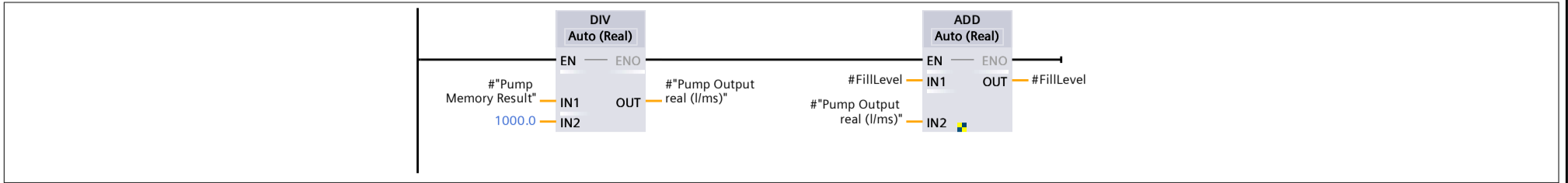

Network 5: Random value for disturbance - 1st step

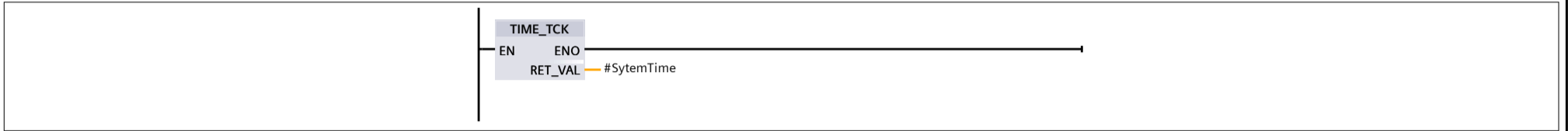

Network 6: random value of disturbance- 2nd step

```
0001 #Random := (DWORD_TO_DINT(#SytemTime) MOD 10);
```

Network 7: random disturbance strength

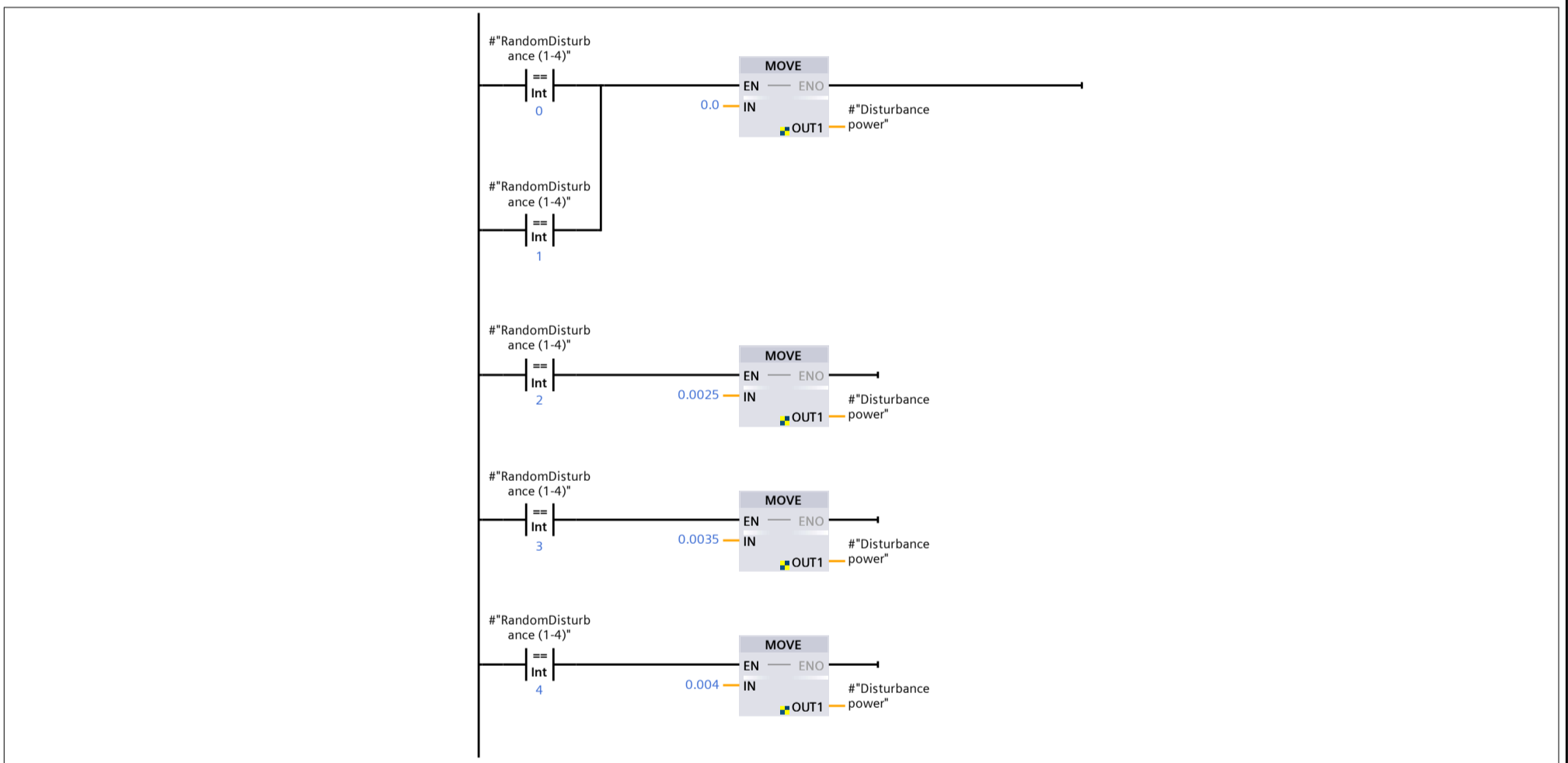

Network 8: Disturbance- random

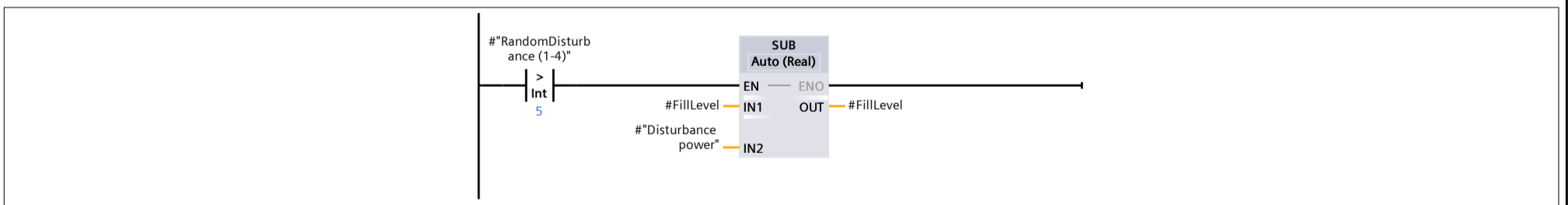

Network 9: Disturbance- outflow

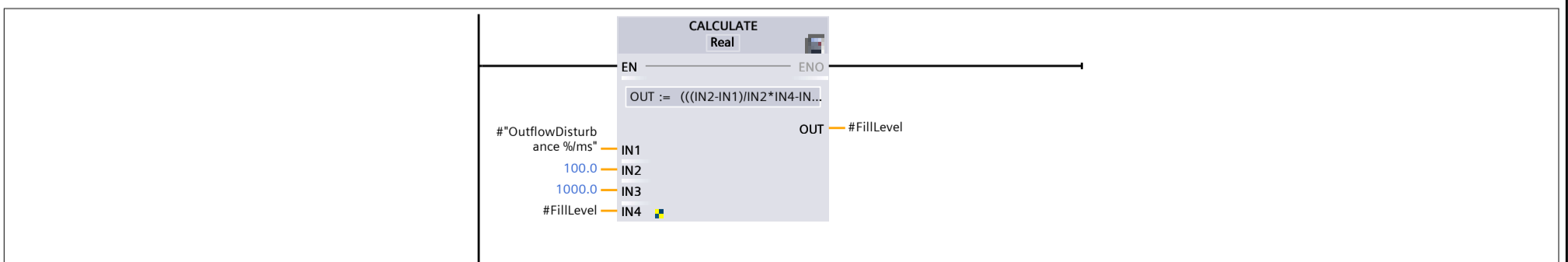

Network 10: fill level clamping

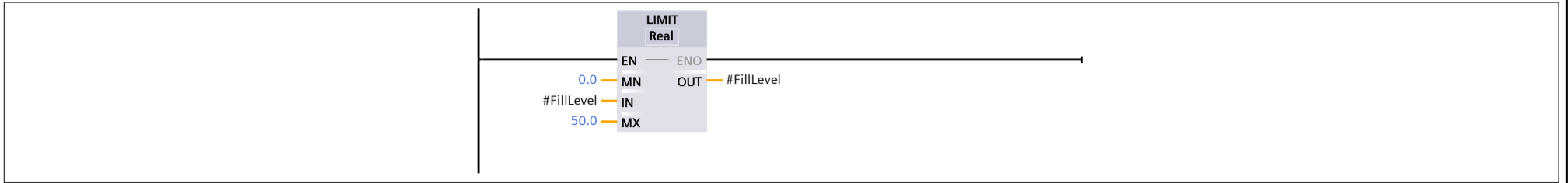

PID_PWM and PID_Output / PLC_1 [CPU 1512C-1 PN] / Program blocks

Cyclic_interrupt_1ms_TANK2Simulation [OB30]

Cyclic_interrupt_1ms_TANK2Simulation Properties

General

Name	Cyclic_interrupt_1ms_TANK2Simulation	Number	30	Type	OB	Language	LAD
-------------	--------------------------------------	---------------	----	-------------	----	-----------------	-----

Numbering Automatic

Information

Title		Author		Comment		Family	
Version	0.1	User-defined ID					

Name	Data type	Default value	Comment
▼ Input			
Initial_Call	Bool		Initial call of this OB
Event_Count	Int		Events discarded
Temp			
Constant			

Network 1:

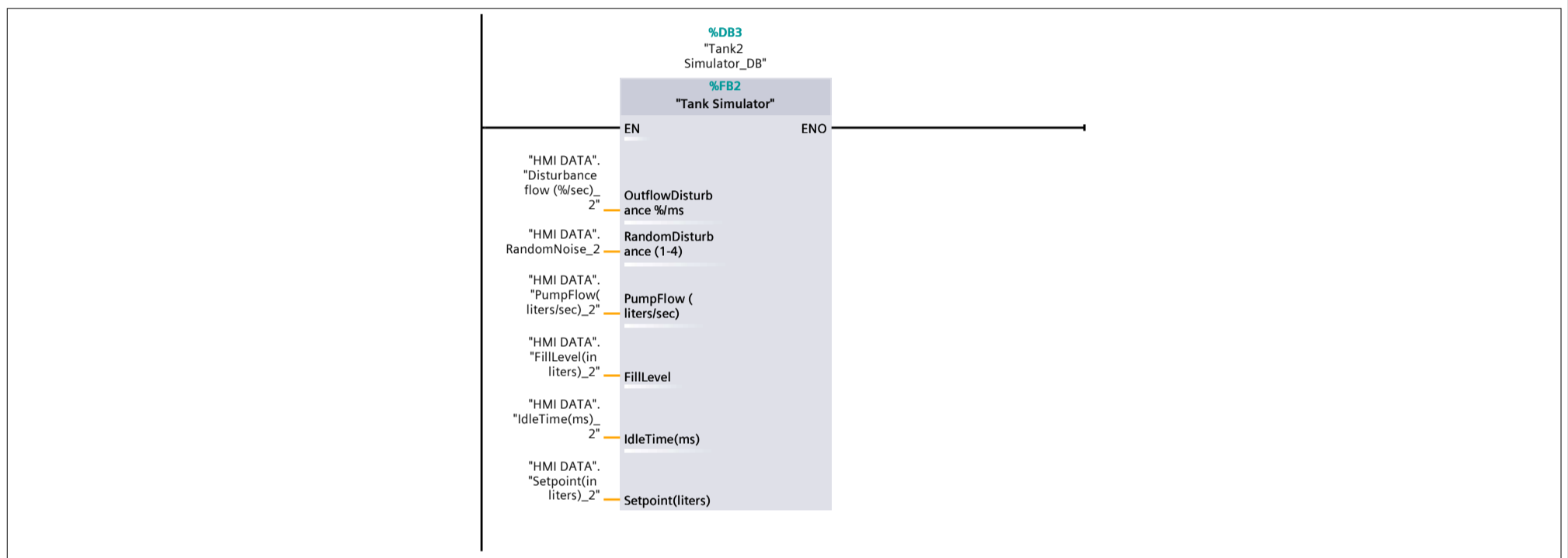

Instrumentation Tools

Totally Integrated Automation Portal

PID_PWM and PID_Output / PLC_1 [CPU 1512C-1 PN] / Program blocks

HMI DATA [DB2]

HMI DATA Properties

General

Name	HMI DATA	Number	2	Type	DB	Language	DB
------	----------	--------	---	------	----	----------	----

Numbering	Automatic
-----------	-----------

Information

Title		Author		Comment		Family	
-------	--	--------	--	---------	--	--------	--

Version	0.1	User-defined ID	
---------	-----	-----------------	--

Name	Data type	Start value	Retain	Accessible from HMI/OPC UA/Web API	Writ-able from HMI/ OPC UA/ Web API	Visible in HMI engi-neering	Setpoint	Supervi-sion	Comment
▼ Static									
FillLevel(in liters)	Real	0.0	False	True	True	True	False		
Setpoint(in liters)	Real	0.0	False	True	True	True	False		
PumpFlow(liters/sec)	Real	0.0	False	True	True	True	False		
PLC_Output	Int	0	False	True	True	True	False		
SystemNoise	Real	0.0	False	True	True	True	False		
Tolerance(in liters)	Real	0.0	False	True	True	True	False		
IdleTime(ms)	Int	0	False	True	True	True	False		
RandomNoise	Int	0	False	True	True	True	False		
EmptyTank	Bool	false	False	True	True	True	False		
Disturbance flow (%/sec)	Real	0.0	False	True	True	True	False		
Disturbance flow (%/sec)_2	Real	0.0	False	True	True	True	False		
FillLevel(in liters)_2	Real	0.0	False	True	True	True	False		
Setpoint(in liters)_2	Real	0.0	False	True	True	True	False		
PumpFlow(liters/sec)_2	Real	0.0	False	True	True	True	False		
PLC_Output_2	Bool	false	False	True	True	True	False		
SystemNoise_2	Real	0.0	False	True	True	True	False		
Tolerance(in liters)_2	Real	0.0	False	True	True	True	False		
IdleTime(ms)_2	Int	0	False	True	True	True	False		
RandomNoise_2	Int	0	False	True	True	True	False		
EmptyTank_2	Bool	false	False	True	True	True	False		

Instrumentation Tools

Totally Integrated Automation Portal

PID_PWM and PID_Output / PLC_1 [CPU 1512C-1 PN] / Program blocks

Tank Simulator_DB [DB5]

Tank Simulator_DB Properties

General

Name	Tank Simulator_DB	Number	5	Type	DB	Language	DB
Numbering	Automatic						

Information

Title		Author		Comment		Family	
Version	0.1	User-defined ID					

Name	Data type	Start value	Retain	Accessible from HMI/OPC UA/Web API	Writable from HMI/OPC UA/Web API	Visible in HMI engineering	Setpoint	Supervision	Comment
▼ Input									
OutflowDisturbance %/ms	Real	0.0	False	True	True	True	False		
RandomDisturbance (1-4)	Int	0	False	True	True	True	False		
PumpFlow (liters/sec)	Real	0.0	False	True	True	True	False		
Output									
▼ InOut									
FillLevel	Real	0.0	False	True	True	True	False		
IdleTime(ms)	Int	0	False	True	True	True	False		
Setpoint(liters)	Real	0.0	False	True	True	True	False		
▼ Static									
Pump Output real (l/ms)	Real	0.0	False	True	True	True	False		
▼ Pump Memory	Array[0..9999] of Real		False	True	True	True	False		
Pump Memory[0]	Real	0.0	False	True	True	True	False		
Pump Memory[1]	Real	0.0	False	True	True	True	False		
Pump Memory[2]	Real	0.0	False	True	True	True	False		
Pump Memory[3]	Real	0.0	False	True	True	True	False		
Pump Memory[4]	Real	0.0	False	True	True	True	False		
Pump Memory[5]	Real	0.0	False	True	True	True	False		
Pump Memory[6]	Real	0.0	False	True	True	True	False		
Pump Memory[7]	Real	0.0	False	True	True	True	False		
Pump Memory[8]	Real	0.0	False	True	True	True	False		
Pump Memory[9]	Real	0.0	False	True	True	True	False		
Pump Memory[10]	Real	0.0	False	True	True	True	False		
Pump Memory[11]	Real	0.0	False	True	True	True	False		
Pump Memory[12]	Real	0.0	False	True	True	True	False		
Pump Memory[13]	Real	0.0	False	True	True	True	False		
Pump Memory[14]	Real	0.0	False	True	True	True	False		
Pump Memory[15]	Real	0.0	False	True	True	True	False		
Pump Memory[16]	Real	0.0	False	True	True	True	False		
Pump Memory[17]	Real	0.0	False	True	True	True	False		
Pump Memory[18]	Real	0.0	False	True	True	True	False		
Pump Memory[19]	Real	0.0	False	True	True	True	False		
Pump Memory[20]	Real	0.0	False	True	True	True	False		
Pump Memory[21]	Real	0.0	False	True	True	True	False		
Pump Memory[22]	Real	0.0	False	True	True	True	False		
Pump Memory[23]	Real	0.0	False	True	True	True	False		
Pump Memory[24]	Real	0.0	False	True	True	True	False		
Pump Memory[25]	Real	0.0	False	True	True	True	False		
Pump Memory[26]	Real	0.0	False	True	True	True	False		
Pump Memory[27]	Real	0.0	False	True	True	True	False		
Pump Memory[28]	Real	0.0	False	True	True	True	False		
Pump Memory[29]	Real	0.0	False	True	True	True	False		
Pump Memory[30]	Real	0.0	False	True	True	True	False		
Pump Memory[31]	Real	0.0	False	True	True	True	False		
Pump Memory[32]	Real	0.0	False	True	True	True	False		
Pump Memory[33]	Real	0.0	False	True	True	True	False		
Pump Memory[34]	Real	0.0	False	True	True	True	False		
Pump Memory[35]	Real	0.0	False	True	True	True	False		
Pump Memory[36]	Real	0.0	False	True	True	True	False		
Pump Memory[37]	Real	0.0	False	True	True	True	False		
Pump Memory[38]	Real	0.0	False	True	True	True	False		
Pump Memory[39]	Real	0.0	False	True	True	True	False		
Pump Memory[40]	Real	0.0	False	True	True	True	False		
Pump Memory[41]	Real	0.0	False	True	True	True	False		
Pump Memory[42]	Real	0.0	False	True	True	True	False		
Pump Memory[43]	Real	0.0	False	True	True	True	False		
Pump Memory[44]	Real	0.0	False	True	True	True	False		
Pump Memory[45]	Real	0.0	False	True	True	True	False		
Pump Memory[46]	Real	0.0	False	True	True	True	False		

Instrumentation Tools

Totally Integrated Automation Portal										
Name	Data type	Start value	Retain	Accessible from HMI/OPC UA/Web API	Writ-able from HMI/ OPC UA/ Web API	Visible in HMI engi-neering	Setpoint	Supervi-sion	Comment	
Pump Memory[47]	Real	0.0	False	True	True	True	False			
Pump Memory[48]	Real	0.0	False	True	True	True	False			
Pump Memory[49]	Real	0.0	False	True	True	True	False			
Pump Memory[50]	Real	0.0	False	True	True	True	False			
Pump Memory[51]	Real	0.0	False	True	True	True	False			
Pump Memory[52]	Real	0.0	False	True	True	True	False			
Pump Memory[53]	Real	0.0	False	True	True	True	False			
Pump Memory[54]	Real	0.0	False	True	True	True	False			
Pump Memory[55]	Real	0.0	False	True	True	True	False			
Pump Memory[56]	Real	0.0	False	True	True	True	False			
Pump Memory[57]	Real	0.0	False	True	True	True	False			
Pump Memory[58]	Real	0.0	False	True	True	True	False			
Pump Memory[59]	Real	0.0	False	True	True	True	False			
Pump Memory[60]	Real	0.0	False	True	True	True	False			
Pump Memory[61]	Real	0.0	False	True	True	True	False			
Pump Memory[62]	Real	0.0	False	True	True	True	False			
Pump Memory[63]	Real	0.0	False	True	True	True	False			
Pump Memory[64]	Real	0.0	False	True	True	True	False			
Pump Memory[65]	Real	0.0	False	True	True	True	False			
Pump Memory[66]	Real	0.0	False	True	True	True	False			
Pump Memory[67]	Real	0.0	False	True	True	True	False			
Pump Memory[68]	Real	0.0	False	True	True	True	False			
Pump Memory[69]	Real	0.0	False	True	True	True	False			
Pump Memory[70]	Real	0.0	False	True	True	True	False			
Pump Memory[71]	Real	0.0	False	True	True	True	False			
Pump Memory[72]	Real	0.0	False	True	True	True	False			
Pump Memory[73]	Real	0.0	False	True	True	True	False			
Pump Memory[74]	Real	0.0	False	True	True	True	False			
Pump Memory[75]	Real	0.0	False	True	True	True	False			
Pump Memory[76]	Real	0.0	False	True	True	True	False			
Pump Memory[77]	Real	0.0	False	True	True	True	False			
Pump Memory[78]	Real	0.0	False	True	True	True	False			
Pump Memory[79]	Real	0.0	False	True	True	True	False			
Pump Memory[80]	Real	0.0	False	True	True	True	False			
Pump Memory[81]	Real	0.0	False	True	True	True	False			
Pump Memory[82]	Real	0.0	False	True	True	True	False			
Pump Memory[83]	Real	0.0	False	True	True	True	False			
Pump Memory[84]	Real	0.0	False	True	True	True	False			
Pump Memory[85]	Real	0.0	False	True	True	True	False			
Pump Memory[86]	Real	0.0	False	True	True	True	False			
Pump Memory[87]	Real	0.0	False	True	True	True	False			
Pump Memory[88]	Real	0.0	False	True	True	True	False			
Pump Memory[89]	Real	0.0	False	True	True	True	False			
Pump Memory[90]	Real	0.0	False	True	True	True	False			
Pump Memory[91]	Real	0.0	False	True	True	True	False			
Pump Memory[92]	Real	0.0	False	True	True	True	False			
Pump Memory[93]	Real	0.0	False	True	True	True	False			
Pump Memory[94]	Real	0.0	False	True	True	True	False			
Pump Memory[95]	Real	0.0	False	True	True	True	False			
Pump Memory[96]	Real	0.0	False	True	True	True	False			
Pump Memory[97]	Real	0.0	False	True	True	True	False			
Pump Memory[98]	Real	0.0	False	True	True	True	False			
Pump Memory[99]	Real	0.0	False	True	True	True	False			
Pump Memory[100]	Real	0.0	False	True	True	True	False			
Pump Memory[101]	Real	0.0	False	True	True	True	False			
Pump Memory[102]	Real	0.0	False	True	True	True	False			
Pump Memory[103]	Real	0.0	False	True	True	True	False			
Pump Memory[104]	Real	0.0	False	True	True	True	False			
Pump Memory[105]	Real	0.0	False	True	True	True	False			
Pump Memory[106]	Real	0.0	False	True	True	True	False			
Pump Memory[107]	Real	0.0	False	True	True	True	False			
Pump Memory[108]	Real	0.0	False	True	True	True	False			
Pump Memory[109]	Real	0.0	False	True	True	True	False			
Pump Memory[110]	Real	0.0	False	True	True	True	False			
Pump Memory[111]	Real	0.0	False	True	True	True	False			
Pump Memory[112]	Real	0.0	False	True	True	True	False			
Pump Memory[113]	Real	0.0	False	True	True	True	False			
Pump Memory[114]	Real	0.0	False	True	True	True	False			
Pump Memory[115]	Real	0.0	False	True	True	True	False			
Pump Memory[116]	Real	0.0	False	True	True	True	False			
Pump Memory[117]	Real	0.0	False	True	True	True	False			
Pump Memory[118]	Real	0.0	False	True	True	True	False			
Pump Memory[119]	Real	0.0	False	True	True	True	False			

Instrumentation Tools

Totally Integrated Automation Portal										
Name	Data type	Start value	Retain	Accessible from HMI/OPC UA/Web API	Writ-able from HMI/ OPC UA/ Web API	Visible in HMI engi-neering	Setpoint	Supervi-sion	Comment	
Pump Memory[9975]	Real	0.0	False	True	True	True	False			
Pump Memory[9976]	Real	0.0	False	True	True	True	False			
Pump Memory[9977]	Real	0.0	False	True	True	True	False			
Pump Memory[9978]	Real	0.0	False	True	True	True	False			
Pump Memory[9979]	Real	0.0	False	True	True	True	False			
Pump Memory[9980]	Real	0.0	False	True	True	True	False			
Pump Memory[9981]	Real	0.0	False	True	True	True	False			
Pump Memory[9982]	Real	0.0	False	True	True	True	False			
Pump Memory[9983]	Real	0.0	False	True	True	True	False			
Pump Memory[9984]	Real	0.0	False	True	True	True	False			
Pump Memory[9985]	Real	0.0	False	True	True	True	False			
Pump Memory[9986]	Real	0.0	False	True	True	True	False			
Pump Memory[9987]	Real	0.0	False	True	True	True	False			
Pump Memory[9988]	Real	0.0	False	True	True	True	False			
Pump Memory[9989]	Real	0.0	False	True	True	True	False			
Pump Memory[9990]	Real	0.0	False	True	True	True	False			
Pump Memory[9991]	Real	0.0	False	True	True	True	False			
Pump Memory[9992]	Real	0.0	False	True	True	True	False			
Pump Memory[9993]	Real	0.0	False	True	True	True	False			
Pump Memory[9994]	Real	0.0	False	True	True	True	False			
Pump Memory[9995]	Real	0.0	False	True	True	True	False			
Pump Memory[9996]	Real	0.0	False	True	True	True	False			
Pump Memory[9997]	Real	0.0	False	True	True	True	False			
Pump Memory[9998]	Real	0.0	False	True	True	True	False			
Pump Memory[9999]	Real	0.0	False	True	True	True	False			
Pump Memory i	Int	0	False	True	True	True	False			
Pump Memory Result	Real	0.0	False	True	True	True	False			

PID_PWM and PID_Output / PLC_1 [CPU 1512C-1 PN] / Program blocks

Cyclic interrupt_TankLevel_PID_Output [OB31]

Cyclic interrupt_TankLevel_PID_Output Properties

General

Name	Cyclic interrupt_TankLevel_PID_Output	Number	31	Type	OB	Language	LAD
-------------	---------------------------------------	---------------	----	-------------	----	-----------------	-----

Numbering	Automatic
------------------	-----------

Information

Title		Author		Comment		Family	
Version	0.1	User-defined ID					

Name	Data type	Default value	Comment
▼ Input			
Initial_Call	Bool		Initial call of this OB
Event_Count	Int		Events discarded
Temp			
Constant			

Network 1:

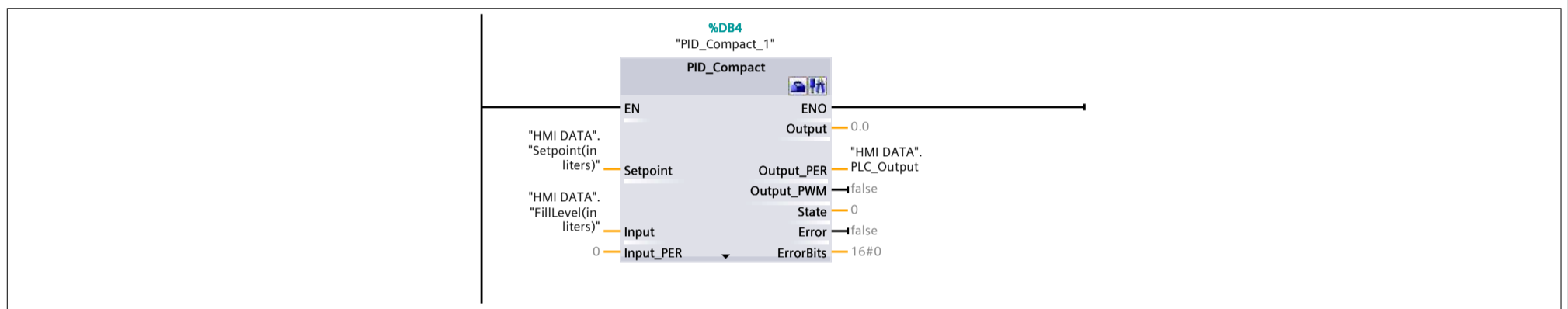

PID_PWM and PID_Output / PLC_1 [CPU 1512C-1 PN] / Program blocks

Cyclic interrupt_TankLevel_PID_PWM [OB33]

Cyclic interrupt_TankLevel_PID_PWM Properties

General

Name	Cyclic interrupt_TankLevel_PID_PWM	Number	33	Type	OB	Language	LAD
-------------	------------------------------------	---------------	----	-------------	----	-----------------	-----

Numbering	Automatic
------------------	-----------

Information

Title		Author		Comment		Family	
Version	0.1	User-defined ID					

Name	Data type	Default value	Comment
▼ Input			
Initial_Call	Bool		Initial call of this OB
Event_Count	Int		Events discarded
Temp			
Constant			

Network 1: PID controller for TANK2

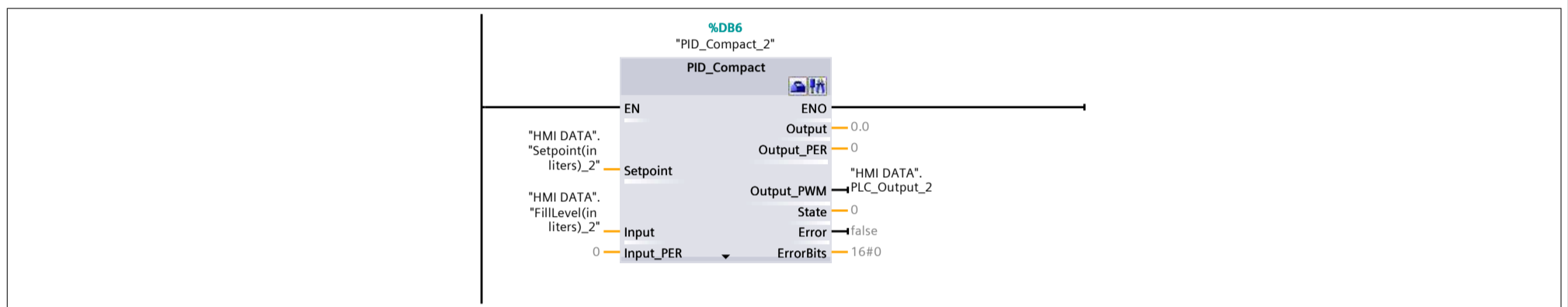

PID_PWM and PID_Output / PLC_1 [CPU 1512C-1 PN] / Program blocks

Cyclic_interrupt_1ms_TANK1Simulation [OB32]

Cyclic_interrupt_1ms_TANK1Simulation Properties

General

Name	Cyclic_interrupt_1ms_TANK1Simulation	Number	32	Type	OB	Language	LAD
-------------	--------------------------------------	---------------	----	-------------	----	-----------------	-----

Numbering Automatic

Information

Title		Author		Comment		Family	
Version	0.1	User-defined ID					

Name	Data type	Default value	Comment
▼ Input			
Initial_Call	Bool		Initial call of this OB
Event_Count	Int		Events discarded
Temp			
Constant			

Network 1: tank 1 simulator

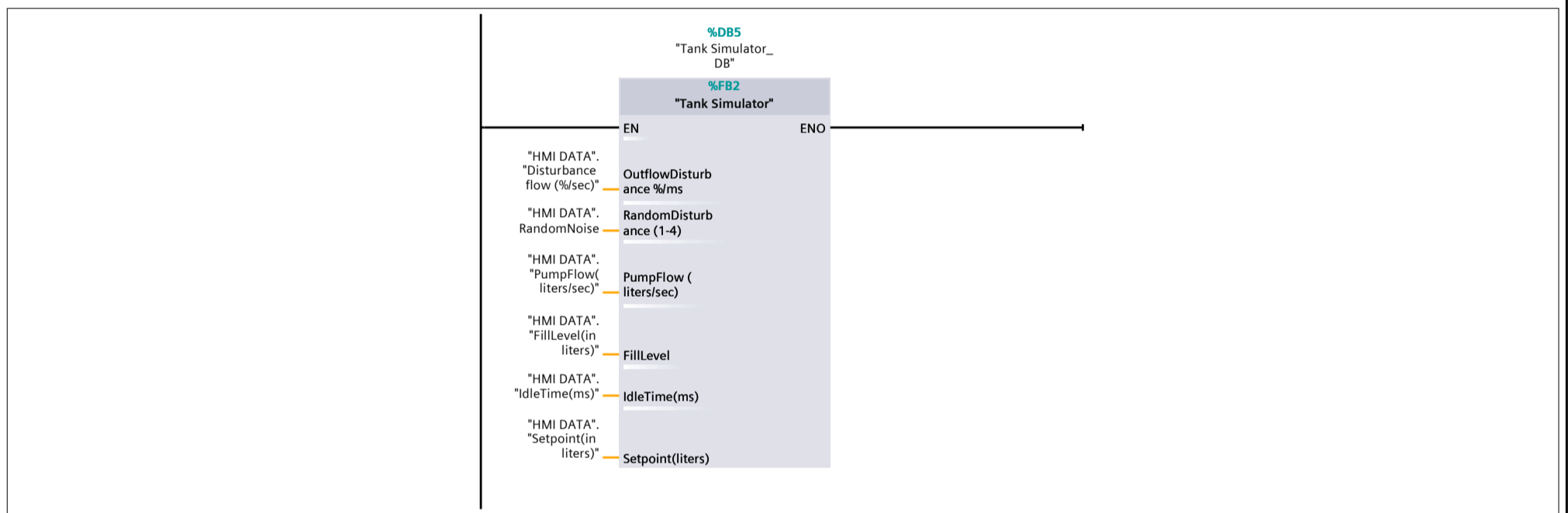

PID_PWM and PID_Output / PLC_1 [CPU 1512C-1 PN] / Program blocks

Tank2 Simulator_DB [DB3]

Tank2 Simulator_DB Properties

General

Name	Tank2 Simulator_DB	Number	3	Type	DB	Language	DB
Numbering	Automatic						

Information

Title		Author		Comment		Family	
Version	0.1	User-defined ID					

Name	Data type	Start value	Retain	Accessible from HMI/OPC UA/Web API	Writable from HMI/OPC UA/Web API	Visible in HMI engineering	Setpoint	Supervision	Comment
▼ Input									
OutflowDisturbance %/ms	Real	0.0	False	True	True	True	False		
RandomDisturbance (1-4)	Int	0	False	True	True	True	False		
PumpFlow (liters/sec)	Real	0.0	False	True	True	True	False		
Output									
▼ InOut									
FillLevel	Real	0.0	False	True	True	True	False		
IdleTime(ms)	Int	0	False	True	True	True	False		
Setpoint(liters)	Real	0.0	False	True	True	True	False		
▼ Static									
Pump Output real (l/ms)	Real	0.0	False	True	True	True	False		
▼ Pump Memory	Array[0..9999] of Real		False	True	True	True	False		
Pump Memory[0]	Real	0.0	False	True	True	True	False		
Pump Memory[1]	Real	0.0	False	True	True	True	False		
Pump Memory[2]	Real	0.0	False	True	True	True	False		
Pump Memory[3]	Real	0.0	False	True	True	True	False		
Pump Memory[4]	Real	0.0	False	True	True	True	False		
Pump Memory[5]	Real	0.0	False	True	True	True	False		
Pump Memory[6]	Real	0.0	False	True	True	True	False		
Pump Memory[7]	Real	0.0	False	True	True	True	False		
Pump Memory[8]	Real	0.0	False	True	True	True	False		
Pump Memory[9]	Real	0.0	False	True	True	True	False		
Pump Memory[10]	Real	0.0	False	True	True	True	False		
Pump Memory[11]	Real	0.0	False	True	True	True	False		
Pump Memory[12]	Real	0.0	False	True	True	True	False		
Pump Memory[13]	Real	0.0	False	True	True	True	False		
Pump Memory[14]	Real	0.0	False	True	True	True	False		
Pump Memory[15]	Real	0.0	False	True	True	True	False		
Pump Memory[16]	Real	0.0	False	True	True	True	False		
Pump Memory[17]	Real	0.0	False	True	True	True	False		
Pump Memory[18]	Real	0.0	False	True	True	True	False		
Pump Memory[19]	Real	0.0	False	True	True	True	False		
Pump Memory[20]	Real	0.0	False	True	True	True	False		
Pump Memory[21]	Real	0.0	False	True	True	True	False		
Pump Memory[22]	Real	0.0	False	True	True	True	False		
Pump Memory[23]	Real	0.0	False	True	True	True	False		
Pump Memory[24]	Real	0.0	False	True	True	True	False		
Pump Memory[25]	Real	0.0	False	True	True	True	False		
Pump Memory[26]	Real	0.0	False	True	True	True	False		
Pump Memory[27]	Real	0.0	False	True	True	True	False		
Pump Memory[28]	Real	0.0	False	True	True	True	False		
Pump Memory[29]	Real	0.0	False	True	True	True	False		
Pump Memory[30]	Real	0.0	False	True	True	True	False		
Pump Memory[31]	Real	0.0	False	True	True	True	False		
Pump Memory[32]	Real	0.0	False	True	True	True	False		
Pump Memory[33]	Real	0.0	False	True	True	True	False		
Pump Memory[34]	Real	0.0	False	True	True	True	False		
Pump Memory[35]	Real	0.0	False	True	True	True	False		
Pump Memory[36]	Real	0.0	False	True	True	True	False		
Pump Memory[37]	Real	0.0	False	True	True	True	False		
Pump Memory[38]	Real	0.0	False	True	True	True	False		
Pump Memory[39]	Real	0.0	False	True	True	True	False		
Pump Memory[40]	Real	0.0	False	True	True	True	False		
Pump Memory[41]	Real	0.0	False	True	True	True	False		
Pump Memory[42]	Real	0.0	False	True	True	True	False		
Pump Memory[43]	Real	0.0	False	True	True	True	False		
Pump Memory[44]	Real	0.0	False	True	True	True	False		
Pump Memory[45]	Real	0.0	False	True	True	True	False		
Pump Memory[46]	Real	0.0	False	True	True	True	False		

Instrumentation Tools

Totally Integrated Automation Portal										
Name	Data type	Start value	Retain	Accessible from HMI/OPC UA/Web API	Writ-able from HMI/ OPC UA/ Web API	Visible in HMI engi-neering	Setpoint	Supervi-sion	Comment	
Pump Memory[47]	Real	0.0	False	True	True	True	False			
Pump Memory[48]	Real	0.0	False	True	True	True	False			
Pump Memory[49]	Real	0.0	False	True	True	True	False			
Pump Memory[50]	Real	0.0	False	True	True	True	False			
Pump Memory[51]	Real	0.0	False	True	True	True	False			
Pump Memory[52]	Real	0.0	False	True	True	True	False			
Pump Memory[53]	Real	0.0	False	True	True	True	False			
Pump Memory[54]	Real	0.0	False	True	True	True	False			
Pump Memory[55]	Real	0.0	False	True	True	True	False			
Pump Memory[56]	Real	0.0	False	True	True	True	False			
Pump Memory[57]	Real	0.0	False	True	True	True	False			
Pump Memory[58]	Real	0.0	False	True	True	True	False			
Pump Memory[59]	Real	0.0	False	True	True	True	False			
Pump Memory[60]	Real	0.0	False	True	True	True	False			
Pump Memory[61]	Real	0.0	False	True	True	True	False			
Pump Memory[62]	Real	0.0	False	True	True	True	False			
Pump Memory[63]	Real	0.0	False	True	True	True	False			
Pump Memory[64]	Real	0.0	False	True	True	True	False			
Pump Memory[65]	Real	0.0	False	True	True	True	False			
Pump Memory[66]	Real	0.0	False	True	True	True	False			
Pump Memory[67]	Real	0.0	False	True	True	True	False			
Pump Memory[68]	Real	0.0	False	True	True	True	False			
Pump Memory[69]	Real	0.0	False	True	True	True	False			
Pump Memory[70]	Real	0.0	False	True	True	True	False			
Pump Memory[71]	Real	0.0	False	True	True	True	False			
Pump Memory[72]	Real	0.0	False	True	True	True	False			
Pump Memory[73]	Real	0.0	False	True	True	True	False			
Pump Memory[74]	Real	0.0	False	True	True	True	False			
Pump Memory[75]	Real	0.0	False	True	True	True	False			
Pump Memory[76]	Real	0.0	False	True	True	True	False			
Pump Memory[77]	Real	0.0	False	True	True	True	False			
Pump Memory[78]	Real	0.0	False	True	True	True	False			
Pump Memory[79]	Real	0.0	False	True	True	True	False			
Pump Memory[80]	Real	0.0	False	True	True	True	False			
Pump Memory[81]	Real	0.0	False	True	True	True	False			
Pump Memory[82]	Real	0.0	False	True	True	True	False			
Pump Memory[83]	Real	0.0	False	True	True	True	False			
Pump Memory[84]	Real	0.0	False	True	True	True	False			
Pump Memory[85]	Real	0.0	False	True	True	True	False			
Pump Memory[86]	Real	0.0	False	True	True	True	False			
Pump Memory[87]	Real	0.0	False	True	True	True	False			
Pump Memory[88]	Real	0.0	False	True	True	True	False			
Pump Memory[89]	Real	0.0	False	True	True	True	False			
Pump Memory[90]	Real	0.0	False	True	True	True	False			
Pump Memory[91]	Real	0.0	False	True	True	True	False			
Pump Memory[92]	Real	0.0	False	True	True	True	False			
Pump Memory[93]	Real	0.0	False	True	True	True	False			
Pump Memory[94]	Real	0.0	False	True	True	True	False			
Pump Memory[95]	Real	0.0	False	True	True	True	False			
Pump Memory[96]	Real	0.0	False	True	True	True	False			
Pump Memory[97]	Real	0.0	False	True	True	True	False			
Pump Memory[98]	Real	0.0	False	True	True	True	False			
Pump Memory[99]	Real	0.0	False	True	True	True	False			
Pump Memory[100]	Real	0.0	False	True	True	True	False			
Pump Memory[101]	Real	0.0	False	True	True	True	False			
Pump Memory[102]	Real	0.0	False	True	True	True	False			
Pump Memory[103]	Real	0.0	False	True	True	True	False			
Pump Memory[104]	Real	0.0	False	True	True	True	False			
Pump Memory[105]	Real	0.0	False	True	True	True	False			
Pump Memory[106]	Real	0.0	False	True	True	True	False			
Pump Memory[107]	Real	0.0	False	True	True	True	False			
Pump Memory[108]	Real	0.0	False	True	True	True	False			
Pump Memory[109]	Real	0.0	False	True	True	True	False			
Pump Memory[110]	Real	0.0	False	True	True	True	False			
Pump Memory[111]	Real	0.0	False	True	True	True	False			
Pump Memory[112]	Real	0.0	False	True	True	True	False			
Pump Memory[113]	Real	0.0	False	True	True	True	False			
Pump Memory[114]	Real	0.0	False	True	True	True	False			
Pump Memory[115]	Real	0.0	False	True	True	True	False			
Pump Memory[116]	Real	0.0	False	True	True	True	False			
Pump Memory[117]	Real	0.0	False	True	True	True	False			
Pump Memory[118]	Real	0.0	False	True	True	True	False			
Pump Memory[119]	Real	0.0	False	True	True	True	False			

Instrumentation Tools

Totally Integrated Automation Portal										
Name	Data type	Start value	Retain	Accessible from HMI/OPC UA/Web API	Writ-able from HMI/ OPC UA/ Web API	Visible in HMI engi-neering	Setpoint	Supervi-sion	Comment	
Pump Memory[9975]	Real	0.0	False	True	True	True	False			
Pump Memory[9976]	Real	0.0	False	True	True	True	False			
Pump Memory[9977]	Real	0.0	False	True	True	True	False			
Pump Memory[9978]	Real	0.0	False	True	True	True	False			
Pump Memory[9979]	Real	0.0	False	True	True	True	False			
Pump Memory[9980]	Real	0.0	False	True	True	True	False			
Pump Memory[9981]	Real	0.0	False	True	True	True	False			
Pump Memory[9982]	Real	0.0	False	True	True	True	False			
Pump Memory[9983]	Real	0.0	False	True	True	True	False			
Pump Memory[9984]	Real	0.0	False	True	True	True	False			
Pump Memory[9985]	Real	0.0	False	True	True	True	False			
Pump Memory[9986]	Real	0.0	False	True	True	True	False			
Pump Memory[9987]	Real	0.0	False	True	True	True	False			
Pump Memory[9988]	Real	0.0	False	True	True	True	False			
Pump Memory[9989]	Real	0.0	False	True	True	True	False			
Pump Memory[9990]	Real	0.0	False	True	True	True	False			
Pump Memory[9991]	Real	0.0	False	True	True	True	False			
Pump Memory[9992]	Real	0.0	False	True	True	True	False			
Pump Memory[9993]	Real	0.0	False	True	True	True	False			
Pump Memory[9994]	Real	0.0	False	True	True	True	False			
Pump Memory[9995]	Real	0.0	False	True	True	True	False			
Pump Memory[9996]	Real	0.0	False	True	True	True	False			
Pump Memory[9997]	Real	0.0	False	True	True	True	False			
Pump Memory[9998]	Real	0.0	False	True	True	True	False			
Pump Memory[9999]	Real	0.0	False	True	True	True	False			
Pump Memory i	Int	0	False	True	True	True	False			
Pump Memory Result	Real	0.0	False	True	True	True	False			

Instrumentation Tools

Totally Integrated Automation Portal

PID_PWM and PID_Output / PLC_1 [CPU 1512C-1 PN] / Program blocks / System blocks / Program resources

PID_Compact [FB1130]

PID_Compact Properties

General

Name	PID_Compact	Number	1130	Type	FB	Language	SCL
Numbering	Automatic						

Information

Title	Compact PID_Controller with self-tuning	Author	SIMATIC	Comment		Family	COMPPID
Version	2.4	User-defined ID	PID_Cmpt				

Name	Data type	Default value	Retain	Accessible from HMI/OPC UA/Web API	Writ-able from HMI/OPC UA/ Web API	Visible in HMI engi-neering	Setpoint	Supervi-sion	Comment
▼ Input									
Setpoint	Real	0.0	Non-retain	True	True	True	False		controller setpoint input
Input	Real	0.0	Non-retain	True	True	True	False		current value from process in REAL format
Input_PER	Int	0	Non-retain	True	True	True	False		current value from peripheral input
Disturbance	Real	0.0	Non-retain	True	True	True	False		disturbance intrusion
ManualEnable	Bool	false	Non-retain	True	True	True	False		activate manual value to overwrite output value
ManualValue	Real	0.0	Non-retain	True	True	True	False		manual value
ErrorAck	Bool	false	Non-retain	True	True	True	False		reset error message
Reset	Bool	false	Non-retain	True	True	True	False		reset the controller
ModeActivate	Bool	false	Non-retain	True	True	True	False		enable mode
▼ Output									
ScaledInput	Real	0.0	Non-retain	True	False	True	False		current value after scaling
Output	Real	0.0	Non-retain	True	False	True	False		output value in REAL format
Output_PER	Int	0	Non-retain	True	False	True	False		analog output value
Output_PWM	Bool	false	Non-retain	True	False	True	False		pulse width modulated output value
SetpointLimit_H	Bool	false	Non-retain	True	False	True	False		setpoint reached upper limit
SetpointLimit_L	Bool	false	Non-retain	True	False	True	False		setpoint reached lower limit
InputWarning_H	Bool	false	Non-retain	True	False	True	False		current value reached upper warning level
InputWarning_L	Bool	false	Non-retain	True	False	True	False		current value reached lower warning level
State	Int	0	Non-retain	True	False	True	False		current mode of operation (0-Inactive, 1-SUT, 2-TIR, 3-Automatic, 4-Manual, 5-Substitute output)
Error	Bool	false	Non-retain	True	False	True	False		error flag
ErrorBits	DWord	16#0	Retain	True	False	True	False		error message
▼ InOut									
Mode	Int	4	Retain	True	True	True	False		mode selection
▼ Static									
InternalDiagnostic	DWord	0	Non-retain	False	False	False	False		internal diagnostic and version handling
InternalVersion	DWord	DW#16#02040001	Non-retain	True	False	True	False		version of controller
InternalRTVersion	DWord	0	Non-retain	False	False	False	False		version of runtime
IntegralResetMode	Int	4	Non-retain	True	True	True	True		0 smooth, 1 clear, 2 keep, 3 overwrite initial output, 4 like setpoint change
OverwriteInitialOutputValue	Real	0.0	Non-retain	True	True	True	False		initialisation of output value for override control
RunModeByStartup	Bool	true	Non-retain	True	True	True	True		activate Mode after CPU restart
LoadBackUp	Bool	false	Non-retain	True	True	True	False		restore last parameter set
SetSubstituteOutput	Bool	true	Non-retain	True	True	True	True		assignment of output value in State = 5 (FALSE - last valid value, TRUE - SubstituteOutput)
PhysicalUnit	Int	0	Non-retain	True	False	True	True		unit of measurement of the process value and setpoint
PhysicalQuantity	Int	0	Non-retain	True	False	True	True		physical quantity of the process value and setpoint
ActivateRecoverMode	Bool	true	Non-retain	True	True	True	True		FALSE - go to inactive by error, TRUE - activate error treatment
Warning	DWord	16#0	Retain	True	False	True	False		warning message
WarningInternal	DWord	16#0	Retain	True	False	True	False		warning message
Progress	Real	0.0	Non-retain	True	False	True	False		progress of current phase in percent
CurrentSetpoint	Real	0.0	Non-retain	True	False	True	False		current active setpoint value
CancelTuningLevel	Real	10.0	Non-retain	True	True	True	True		cancel level for setpoint change during tuning

Instrumentation Tools

Totally Integrated Automation Portal									
Name	Data type	Default value	Retain	Accessible from HMI/OPC UA/Web API	Writ-able from HMI/OPC UA/ Web API	Visible in HMI engi-neering	Setpoint	Supervi-sion	Comment
SubstituteOutput	Real	0.0	Non-retain	True	True	True	True		substitute output value in case of error
▼ Config	PID_Compact-Config		Non-retain	True	True	True	True		configuration data set
InputPerOn	Bool	true	Non-retain	True	True	True	True		activate peripheral input
InvertControl	Bool	false	Non-retain	True	True	True	True		invert control direction
InputUpperLimit	Real	120.0	Non-retain	True	True	True	True		input (process value) upper limit
InputLowerLimit	Real	0.0	Non-retain	True	True	True	True		input (process value) lower limit
InputUpperWarning	Real	3.402822e+38	Non-retain	True	True	True	True		input (process value) upper level warning
InputLowerWarning	Real	-3.402822e+38	Non-retain	True	True	True	True		input (process value) lower level warning
OutputUpperLimit	Real	100.0	Non-retain	True	True	True	True		output value upper limit
OutputLowerLimit	Real	0.0	Non-retain	True	True	True	True		output value lower limit
SetpointUpperLimit	Real	3.402822e+38	Non-retain	True	True	True	True		setpoint upper limit value
SetpointLowerLimit	Real	-3.402822e+38	Non-retain	True	True	True	True		setpoint lower limit value
MinimumOnTime	Real	0.0	Non-retain	True	True	True	True		PWM minimum on time
MinimumOffTime	Real	0.0	Non-retain	True	True	True	True		PWM minimum off time
▼ InputScaling	PID_Scaling		Non-retain	True	True	True	True		input scaling
UpperPointIn	Real	27648.0	Non-retain	True	True	True	True		high value (input range of scaling)
LowerPointIn	Real	0.0	Non-retain	True	True	True	True		low value (input range of scaling)
UpperPointOut	Real	100.0	Non-retain	True	True	True	True		high value (output range of scaling)
LowerPointOut	Real	0.0	Non-retain	True	True	True	True		low value (output range of scaling)
▼ CycleTime	PID_CycleTime		Non-retain	True	True	True	True		data set for cycle time estimation
StartEstimation	Bool	true	Non-retain	True	True	True	False		start automatic estimation of call cycle time
EnEstimation	Bool	true	Non-retain	True	True	True	True		enable estimation of call cycle time
EnMonitoring	Bool	true	Non-retain	True	True	True	True		enable monitoring of call cycle time
Value	Real	0.1	Non-retain	True	True	True	True		call cycle time
▼ CtrlParamsBackUp	PID_Compact-ControlParams		Non-retain	True	True	True	True		saved parameter set
Gain	Real	1.0	Non-retain	True	True	True	True		proportional gain
Ti	Real	20.0	Non-retain	True	True	True	True		reset time
Td	Real	0.0	Non-retain	True	True	True	True		derivative time
TdFiltRatio	Real	0.2	Non-retain	True	True	True	True		filter coefficient for derivative part
PWeighting	Real	1.0	Non-retain	True	True	True	True		weighting of proportional part in direct, feedback path
DWeighting	Real	1.0	Non-retain	True	True	True	True		weighting of derivative part in direct, feedback path
Cycle	Real	1.0	Non-retain	True	True	True	True		PID Controller cycle time
▼ PIDSelfTune	PID_Compact-SelfTune		Non-retain	True	True	True	True		data set for self tuning
▼ SUT	PID_Compact-SUT		Non-retain	True	True	True	True		data set for start up tuning
CalculateParams	Bool	false	Non-retain	True	True	True	False		recalculate control parameters with parameters of startup tuning
TuneRule	Int	0	Non-retain	True	True	True	True		tuning rule for SUT (0-CHR PID,1-CHR PI)
State	Int	0	Non-retain	True	False	True	False		current phase of start up tuning
▼ TIR	PID_Compact-TIR		Non-retain	True	True	True	True		data set for tuning in run
RunIn	Bool	false	Non-retain	True	True	True	False		activate run in setpoint without controlling
CalculateParams	Bool	false	Non-retain	True	True	True	False		recalculate control parameters with parameters of tuning in run
TuneRule	Int	0	Non-retain	True	True	True	True		tuning rule for TIR (0-2-A PID auto,fast,slow;3-ZN PID;4-ZN PI;5-ZN P)
State	Int	0	Non-retain	True	False	True	False		current phase of tuning in run
▼ PIDCtrl	PID_Compact-Control		Non-retain	True	True	True	True		data for controlling part
PIDInit	Bool	false	Non-retain	True	True	True	False		initialization of controller
IntegralSum	Real	0.0	Non-retain	True	True	True	False		signal of integral part
▼ Retain	PID_Compact-Retain		Retain	True	True	True	True		retain data
▼ CtrlParams	PID_Compact-ControlParams		Retain	True	True	True	True		actual parameter set

Instrumentation Tools

Totally Integrated Automation Portal										
Name	Data type	Default value	Retain	Accessible from HMI/OPC UA/Web API	Writ-able from HMI/OPC UA/ Web API	Visible in HMI engi-neering	Setpoint	Supervi-sion	Comment	
Gain	Real	1.0	Retain	True	True	True	True		proportional gain	
Ti	Real	20.0	Retain	True	True	True	True		reset time	
Td	Real	0.0	Retain	True	True	True	True		derivative time	
TdFiltRatio	Real	0.2	Retain	True	True	True	True		filter coefficient for deriva-tive part	
PWeighting	Real	1.0	Retain	True	True	True	True		weigthing of proportional part in direct, feedback path	
DWeighting	Real	1.0	Retain	True	True	True	True		weigthing of derivative part in direct, feedback path	
Cycle	Real	1.0	Retain	True	True	True	True		PID Controller cycle time	

PID_PWM and PID_Output / PLC_1 [CPU 1512C-1 PN] / Technology objects

PID_Compact_1 [DB4]

PID_Compact_1 Properties

General

Name	PID_Compact_1	Number	4	Type	DB	Language	DB
Numbering	Automatic						

Information

Title		Author	SIMATIC	Comment		Family	COMPPID
Version	2.4	User-defined ID	PID_Cmpt				

Name	Data type	Start value	Retain	Accessible from HMI/OPC UA/Web API	Writ-able from HMI/OPC UA/ Web API	Visible in HMI engi-neering	Setpoint	Supervi-sion	Comment
▼ Input									
Setpoint	Real	0.0	False	True	True	True	False		controller setpoint input
Input	Real	0.0	False	True	True	True	False		current value from process in REAL format
Input_PER	Int	0	False	True	True	True	False		current value from peripheral input
Disturbance	Real	0.0	False	True	True	True	False		disturbance intrusion
ManualEnable	Bool	false	False	True	True	True	False		activate manual value to overwrite output value
ManualValue	Real	0.0	False	True	True	True	False		manual value
ErrorAck	Bool	false	False	True	True	True	False		reset error message
Reset	Bool	false	False	True	True	True	False		reset the controller
ModeActivate	Bool	false	False	True	True	True	False		enable mode
▼ Output									
ScaledInput	Real	0.0	False	True	False	True	False		current value after scaling
Output	Real	0.0	False	True	False	True	False		output value in REAL format
Output_PER	Int	0	False	True	False	True	False		analog output value
Output_PWM	Bool	false	False	True	False	True	False		pulse width modulated output value
SetpointLimit_H	Bool	false	False	True	False	True	False		setpoint reached upper limit
SetpointLimit_L	Bool	false	False	True	False	True	False		setpoint reached lower limit
InputWarning_H	Bool	false	False	True	False	True	False		current value reached upper warning level
InputWarning_L	Bool	false	False	True	False	True	False		current value reached lower warning level
State	Int	0	False	True	False	True	False		current mode of operation (0-Inac-tive, 1-SUT, 2-TIR, 3-Automatic, 4-Manual, 5-Substitute output)
Error	Bool	false	False	True	False	True	False		error flag
ErrorBits	DWord	16#0	True	True	False	True	False		error message
▼ InOut									
Mode	Int	3	True	True	True	True	False		mode selection
▼ Static									
InternalDiagnostic	DWord	0	False	False	False	False	False		internal diagnostic and version han-dling
InternalVersion	DWord	DW#16#02040001	False	True	False	True	False		version of controller
InternalRTVersion	DWord	0	False	False	False	False	False		version of runtime
IntegralResetMode	Int	4	False	True	True	True	True		0 smooth, 1 clear, 2 keep, 3 overwrite initial output, 4 like setpoint change
OverwriteInitialOutputValue	Real	0.0	False	True	True	True	False		initialisation of output value for over-ride control
RunModeByStartup	Bool	true	False	True	True	True	True		activate Mode after CPU restart
LoadBackUp	Bool	false	False	True	True	True	False		restore last parameter set
SetSubstituteOutput	Bool	true	False	True	True	True	True		assignment of output value in State = 5 (FALSE - last valid value, TRUE - Sub-stituteOutput)
PhysicalUnit	Int	0	False	True	False	True	True		unit of measurement of the process value and setpoint
PhysicalQuantity	Int	14	False	True	False	True	True		physical quantity of the process value and setpoint
ActivateRecoverMode	Bool	true	False	True	True	True	True		FALSE - go to inactive by error, TRUE - activate error treatment
Warning	DWord	16#0	True	True	False	True	False		warning message
WarningInternal	DWord	16#0	True	True	False	True	False		warning message
Progress	Real	0.0	False	True	False	True	False		progress of current phase in percent
CurrentSetpoint	Real	0.0	False	True	False	True	False		current active setpoint value
CancelTuningLevel	Real	10.0	False	True	True	True	True		cancel level for setpoint change dur-ing tuning
SubstituteOutput	Real	0.0	False	True	True	True	True		substitute output value in case of er-ror
▼ Config	PID_Compact-Config		False	True	True	True	True		configuration data set
InputPerOn	Bool	FALSE	False	True	True	True	True		activate peripheral input
InvertControl	Bool	false	False	True	True	True	True		invert control direction
InputUpperLimit	Real	50.0	False	True	True	True	True		input (process value) upper limit
InputLowerLimit	Real	0.0	False	True	True	True	True		input (process value) lower limit

Instrumentation Tools

Totally Integrated Automation Portal									
Name	Data type	Start value	Retain	Accessible from HMI/OPC UA/Web API	Writable from HMI/OPC UA/Web API	Visible in HMI engineering	Setpoint	Supervision	Comment
InputUpperWarning	Real	3.402822e+38	False	True	True	True	True		input (process value) upper level warning
InputLowerWarning	Real	-3.402822e+38	False	True	True	True	True		input (process value) lower level warning
OutputUpperLimit	Real	100.0	False	True	True	True	True		output value upper limit
OutputLowerLimit	Real	0.0	False	True	True	True	True		output value lower limit
SetpointUpperLimit	Real	3.402822e+38	False	True	True	True	True		setpoint upper limit value
SetpointLowerLimit	Real	-3.402822e+38	False	True	True	True	True		setpoint lower limit value
MinimumOnTime	Real	0.0	False	True	True	True	True		PWM minimum on time
MinimumOffTime	Real	0.0	False	True	True	True	True		PWM minimum off time
▼ InputScaling	PID_Scaling		False	True	True	True	True		input scaling
UpperPointIn	Real	27648.0	False	True	True	True	True		high value (input range of scaling)
LowerPointIn	Real	0.0	False	True	True	True	True		low value (input range of scaling)
UpperPointOut	Real	50.0	False	True	True	True	True		high value (output range of scaling)
LowerPointOut	Real	0.0	False	True	True	True	True		low value (output range of scaling)
▼ CycleTime	PID_CycleTime		False	True	True	True	True		data set for cycle time estimation
StartEstimation	Bool	true	False	True	True	True	False		start automatic estimation of call cycle time
EnEstimation	Bool	true	False	True	True	True	True		enable estimation of call cycle time
EnMonitoring	Bool	true	False	True	True	True	True		enable monitoring of call cycle time
Value	Real	0.1	False	True	True	True	True		call cycle time
▼ CtrlParamsBackUp	PID_Compact-ControlParams		False	True	True	True	True		saved parameter set
Gain	Real	1.0	False	True	True	True	True		proportional gain
Ti	Real	20.0	False	True	True	True	True		reset time
Td	Real	0.0	False	True	True	True	True		derivative time
TdFiltRatio	Real	0.2	False	True	True	True	True		filter coefficient for derivative part
PWeighting	Real	1.0	False	True	True	True	True		weighting of proportional part in direct, feedback path
DWeighting	Real	1.0	False	True	True	True	True		weighting of derivative part in direct, feedback path
Cycle	Real	1.0	False	True	True	True	True		PID Controller cycle time
▼ PIDSelfTune	PID_Compact-SelfTune		False	True	True	True	True		data set for self tuning
▼ SUT	PID_Compact-SUT		False	True	True	True	True		data set for start up tuning
CalculateParams	Bool	false	False	True	True	True	False		recalculate control parameters with parameters of startup tuning
TuneRule	Int	0	False	True	True	True	True		tuning rule for SUT (0-CHR PID,1-CHR PI)
State	Int	0	False	True	False	True	False		current phase of start up tuning
▼ TIR	PID_Compact-TIR		False	True	True	True	True		data set for tuning in run
RunIn	Bool	false	False	True	True	True	False		activate run in setpoint without controlling
CalculateParams	Bool	false	False	True	True	True	False		recalculate control parameters with parameters of tuning in run
TuneRule	Int	0	False	True	True	True	True		tuning rule for TIR (0-2-A PID auto,fast,slow;3-ZN PID;4-ZN PI;5-ZN P)
State	Int	0	False	True	False	True	False		current phase of tuning in run
▼ PIDCtrl	PID_Compact-Control		False	True	True	True	True		data for controlling part
PIDInit	Bool	false	False	True	True	True	False		initialization of controller
IntegralSum	Real	0.0	False	True	True	True	False		signal of integral part
▼ Retain	PID_CompactRetain		True	True	True	True	True		retain data
▼ CtrlParams	PID_Compact-ControlParams		True	True	True	True	True		actual parameter set
Gain	Real	8.990374	True	True	True	True	True		proportional gain
Ti	Real	3.748347	True	True	True	True	True		reset time
Td	Real	0.6559607	True	True	True	True	True		derivative time
TdFiltRatio	Real	0.1	True	True	True	True	True		filter coefficient for derivative part
PWeighting	Real	0.8	True	True	True	True	True		weighting of proportional part in direct, feedback path
DWeighting	Real	0.0	True	True	True	True	True		weighting of derivative part in direct, feedback path
Cycle	Real	0.0767546	True	True	True	True	True		PID Controller cycle time

PID_PWM and PID_Output / PLC_1 [CPU 1512C-1 PN] / Technology objects

PID_Compact_2 [DB6]

PID_Compact_2 Properties

General

Name	PID_Compact_2	Number	6	Type	DB	Language	DB
Numbering	Automatic						

Information

Title		Author	SIMATIC	Comment		Family	COMPPID
Version	2.4	User-defined ID	PID_Cmpt				

Name	Data type	Start value	Retain	Accessible from HMI/OPC UA/Web API	Writable from HMI/OPC UA/Web API	Visible in HMI engineering	Setpoint	Supervision	Comment
▼ Input									
Setpoint	Real	0.0	False	True	True	True	False		controller setpoint input
Input	Real	0.0	False	True	True	True	False		current value from process in REAL format
Input_PER	Int	0	False	True	True	True	False		current value from peripheral input
Disturbance	Real	0.0	False	True	True	True	False		disturbance intrusion
ManualEnable	Bool	false	False	True	True	True	False		activate manual value to overwrite output value
ManualValue	Real	0.0	False	True	True	True	False		manual value
ErrorAck	Bool	false	False	True	True	True	False		reset error message
Reset	Bool	false	False	True	True	True	False		reset the controller
ModeActivate	Bool	false	False	True	True	True	False		enable mode
▼ Output									
ScaledInput	Real	0.0	False	True	False	True	False		current value after scaling
Output	Real	0.0	False	True	False	True	False		output value in REAL format
Output_PER	Int	0	False	True	False	True	False		analog output value
Output_PWM	Bool	false	False	True	False	True	False		pulse width modulated output value
SetpointLimit_H	Bool	false	False	True	False	True	False		setpoint reached upper limit
SetpointLimit_L	Bool	false	False	True	False	True	False		setpoint reached lower limit
InputWarning_H	Bool	false	False	True	False	True	False		current value reached upper warning level
InputWarning_L	Bool	false	False	True	False	True	False		current value reached lower warning level
State	Int	0	False	True	False	True	False		current mode of operation (0-Inactive, 1-SUT, 2-TIR, 3-Automatic, 4-Manual, 5-Substitute output)
Error	Bool	false	False	True	False	True	False		error flag
ErrorBits	DWord	16#0	True	True	False	True	False		error message
▼ InOut									
Mode	Int	3	True	True	True	True	False		mode selection
▼ Static									
InternalDiagnostic	DWord	0	False	False	False	False	False		internal diagnostic and version handling
InternalVersion	DWord	DW#16#02040001	False	True	False	True	False		version of controller
InternalRTVersion	DWord	0	False	False	False	False	False		version of runtime
IntegralResetMode	Int	4	False	True	True	True	True		0 smooth, 1 clear, 2 keep, 3 overwrite initial output, 4 like setpoint change
OverwriteInitialOutputValue	Real	0.0	False	True	True	True	False		initialisation of output value for override control
RunModeByStartup	Bool	true	False	True	True	True	True		activate Mode after CPU restart
LoadBackUp	Bool	false	False	True	True	True	False		restore last parameter set
SetSubstituteOutput	Bool	true	False	True	True	True	True		assignment of output value in State = 5 (FALSE - last valid value, TRUE - SubstituteOutput)
PhysicalUnit	Int	0	False	True	False	True	True		unit of measurement of the process value and setpoint
PhysicalQuantity	Int	14	False	True	False	True	True		physical quantity of the process value and setpoint
ActivateRecoverMode	Bool	true	False	True	True	True	True		FALSE - go to inactive by error, TRUE - activate error treatment
Warning	DWord	16#0	True	True	False	True	False		warning message
WarningInternal	DWord	16#0	True	True	False	True	False		warning message
Progress	Real	0.0	False	True	False	True	False		progress of current phase in percent
CurrentSetpoint	Real	0.0	False	True	False	True	False		current active setpoint value
CancelTuningLevel	Real	10.0	False	True	True	True	True		cancel level for setpoint change during tuning
SubstituteOutput	Real	0.0	False	True	True	True	True		substitute output value in case of error
▼ Config	PID_Compact-Config		False	True	True	True	True		configuration data set
InputPerOn	Bool	FALSE	False	True	True	True	True		activate peripheral input
InvertControl	Bool	false	False	True	True	True	True		invert control direction
InputUpperLimit	Real	50.0	False	True	True	True	True		input (process value) upper limit
InputLowerLimit	Real	0.0	False	True	True	True	True		input (process value) lower limit

Instrumentation Tools

Totally Integrated Automation Portal									
Name	Data type	Start value	Retain	Accessible from HMI/OPC UA/Web API	Writable from HMI/OPC UA/Web API	Visible in HMI engineering	Setpoint	Supervision	Comment
InputUpperWarning	Real	3.402822e+38	False	True	True	True	True		input (process value) upper level warning
InputLowerWarning	Real	-3.402822e+38	False	True	True	True	True		input (process value) lower level warning
OutputUpperLimit	Real	100.0	False	True	True	True	True		output value upper limit
OutputLowerLimit	Real	0.0	False	True	True	True	True		output value lower limit
SetpointUpperLimit	Real	3.402822e+38	False	True	True	True	True		setpoint upper limit value
SetpointLowerLimit	Real	-3.402822e+38	False	True	True	True	True		setpoint lower limit value
MinimumOnTime	Real	0.1	False	True	True	True	True		PWM minimum on time
MinimumOffTime	Real	0.1	False	True	True	True	True		PWM minimum off time
▼ InputScaling	PID_Scaling		False	True	True	True	True		input scaling
UpperPointIn	Real	27648.0	False	True	True	True	True		high value (input range of scaling)
LowerPointIn	Real	0.0	False	True	True	True	True		low value (input range of scaling)
UpperPointOut	Real	100.0	False	True	True	True	True		high value (output range of scaling)
LowerPointOut	Real	0.0	False	True	True	True	True		low value (output range of scaling)
▼ CycleTime	PID_CycleTime		False	True	True	True	True		data set for cycle time estimation
StartEstimation	Bool	true	False	True	True	True	False		start automatic estimation of call cycle time
EnEstimation	Bool	true	False	True	True	True	True		enable estimation of call cycle time
EnMonitoring	Bool	true	False	True	True	True	True		enable monitoring of call cycle time
Value	Real	0.1	False	True	True	True	True		call cycle time
▼ CtrlParamsBackUp	PID_Compact-ControlParams		False	True	True	True	True		saved parameter set
Gain	Real	1.0	False	True	True	True	True		proportional gain
Ti	Real	20.0	False	True	True	True	True		reset time
Td	Real	0.0	False	True	True	True	True		derivative time
TdFiltRatio	Real	0.2	False	True	True	True	True		filter coefficient for derivative part
PWeighting	Real	1.0	False	True	True	True	True		weighting of proportional part in direct, feedback path
DWeighting	Real	1.0	False	True	True	True	True		weighting of derivative part in direct, feedback path
Cycle	Real	1.0	False	True	True	True	True		PID Controller cycle time
▼ PIDSelfTune	PID_Compact-SelfTune		False	True	True	True	True		data set for self tuning
▼ SUT	PID_Compact-SUT		False	True	True	True	True		data set for start up tuning
CalculateParams	Bool	false	False	True	True	True	False		recalculate control parameters with parameters of startup tuning
TuneRule	Int	0	False	True	True	True	True		tuning rule for SUT (0-CHR PID,1-CHR PI)
State	Int	0	False	True	False	True	False		current phase of start up tuning
▼ TIR	PID_Compact-TIR		False	True	True	True	True		data set for tuning in run
RunIn	Bool	false	False	True	True	True	False		activate run in setpoint without controlling
CalculateParams	Bool	false	False	True	True	True	False		recalculate control parameters with parameters of tuning in run
TuneRule	Int	0	False	True	True	True	True		tuning rule for TIR (0-2-A PID auto,fast,slow;3-ZN PID;4-ZN PI;5-ZN P)
State	Int	0	False	True	False	True	False		current phase of tuning in run
▼ PIDCtrl	PID_Compact-Control		False	True	True	True	True		data for controlling part
PIDInit	Bool	false	False	True	True	True	False		initialization of controller
IntegralSum	Real	0.0	False	True	True	True	False		signal of integral part
▼ Retain	PID_CompactRetain		True	True	True	True	True		retain data
▼ CtrlParams	PID_Compact-ControlParams		True	True	True	True	True		actual parameter set
Gain	Real	44.38819	True	True	True	True	True		proportional gain
Ti	Real	2.026601	True	True	True	True	True		reset time
Td	Real	0.3546551	True	True	True	True	True		derivative time
TdFiltRatio	Real	0.1	True	True	True	True	True		filter coefficient for derivative part
PWeighting	Real	0.8	True	True	True	True	True		weighting of proportional part in direct, feedback path
DWeighting	Real	0.0	True	True	True	True	True		weighting of derivative part in direct, feedback path
Cycle	Real	0.1013425	True	True	True	True	True		PID Controller cycle time

PID_PWM and PID_Output / PLC_1 [CPU 1512C-1 PN]

PLC tags

PLC tags						
Icon	Name	Data type	Address	Visible in HMI engineering	Accessible from HMI/OPC UA/Web API	Comment

PID_PWM and PID_Output / PLC_1 [CPU 1512C-1 PN] / PLC tags

Default tag table [63]

PLC tags

Icon	Name	Data type	Address	Visible in HMI engineering	Accessible from HMI/OPC UA/Web API	Comment
------	------	-----------	---------	----------------------------	------------------------------------	---------

PID_PWM and PID_Output / PLC_1 [CPU 1512C-1 PN] / PLC data types / System data types

PID_CompactConfig

PID_CompactConfig Properties

General

Name	PID_CompactConfig	Number	1134	Type	UDT	Language	
-------------	-------------------	---------------	------	-------------	-----	-----------------	--

Numbering

Information

Title	configuration data set	Author		Comment		Family	
--------------	------------------------	---------------	--	----------------	--	---------------	--

Version		User-defined ID	
----------------	--	------------------------	--

Name	Data type	Default value	Accessible from HMI/OPC UA/Web API	Writ-able from HMI/ OPC UA/ Web API	Visible in HMI engi-neering	Setpoint	Comment
InputPerOn	Bool	true	True	True	True	True	activate peripheral input
InvertControl	Bool	false	True	True	True	True	invert control direction
InputUpperLimit	Real	120.0	True	True	True	True	input (process value) upper limit
InputLowerLimit	Real	0.0	True	True	True	True	input (process value) lower limit
InputUpperWarning	Real	3.402822e+38	True	True	True	True	input (process value) upper level warning
InputLowerWarning	Real	-3.402822e+38	True	True	True	True	input (process value) lower level warning
OutputUpperLimit	Real	100.0	True	True	True	True	output value upper limit
OutputLowerLimit	Real	0.0	True	True	True	True	output value lower limit
SetpointUpperLimit	Real	3.402822e+38	True	True	True	True	setpoint upper limit value
SetpointLowerLimit	Real	-3.402822e+38	True	True	True	True	setpoint lower limit value
MinimumOnTime	Real	0.0	True	True	True	True	PWM minimum on time
MinimumOffTime	Real	0.0	True	True	True	True	PWM minimum off time
▼ InputScaling	PID_Scaling		True	True	True	True	input scaling
UpperPointIn	Real	27648.0	True	True	True	True	high value (input range of scaling)
LowerPointIn	Real	0.0	True	True	True	True	low value (input range of scaling)
UpperPointOut	Real	100.0	True	True	True	True	high value (output range of scaling)
LowerPointOut	Real	0.0	True	True	True	True	low value (output range of scaling)

PID_PWM and PID_Output / PLC_1 [CPU 1512C-1 PN] / PLC data types / System data types

PID_Scaling

PID_Scaling Properties

General

Name	PID_Scaling	Number	1135	Type	UDT	Language	
-------------	-------------	---------------	------	-------------	-----	-----------------	--

Numbering

Information

Title	data for scaling	Author		Comment		Family	
--------------	------------------	---------------	--	----------------	--	---------------	--

Version		User-defined ID	
----------------	--	------------------------	--

Name	Data type	Default value	Accessible from HMI/OPC UA/Web API	Writ-able from HMI/ OPC UA/ Web API	Visible in HMI engi-neering	Setpoint	Comment
UpperPointIn	Real	27648.0	True	True	True	True	high value (input range of scaling)
LowerPointIn	Real	0.0	True	True	True	True	low value (input range of scaling)
UpperPointOut	Real	100.0	True	True	True	True	high value (output range of scaling)
LowerPointOut	Real	0.0	True	True	True	True	low value (output range of scaling)

PID_PWM and PID_Output / PLC_1 [CPU 1512C-1 PN] / PLC data types / System data types

PID_CycleTime

PID_CycleTime Properties

General

Name	PID_CycleTime	Number	1137	Type	UDT	Language	
-------------	---------------	---------------	------	-------------	-----	-----------------	--

Numbering

Information

Title	data set for cycle time estimation	Author		Comment		Family	
--------------	------------------------------------	---------------	--	----------------	--	---------------	--

Version		User-defined ID	
----------------	--	------------------------	--

Name	Data type	Default value	Accessible from HMI/OPC UA/Web API	Writ-able from HMI/OPC UA/ Web API	Visible in HMI engineering	Setpoint	Comment
StartEstimation	Bool	true	True	True	True	False	start automatic estimation of call cycle time
EnEstimation	Bool	true	True	True	True	True	enable estimation of call cycle time
EnMonitoring	Bool	true	True	True	True	True	enable monitoring of call cycle time
Value	Real	0.1	True	True	True	True	call cycle time

PID_PWM and PID_Output / PLC_1 [CPU 1512C-1 PN] / PLC data types / System data types

PID_CompactControlParams

PID_CompactControlParams Properties

General

Name	PID_CompactControlParams	Number	1138	Type	UDT	Language	
-------------	--------------------------	---------------	------	-------------	-----	-----------------	--

Numbering

Information

Title	controlling parameter set	Author		Comment		Family	
--------------	---------------------------	---------------	--	----------------	--	---------------	--

Version		User-defined ID	
----------------	--	------------------------	--

Name	Data type	Default value	Accessible from HMI/OPC UA/Web API	Writ-able from HMI/ OPC UA/ Web API	Visible in HMI engi-neering	Setpoint	Comment
Gain	Real	1.0	True	True	True	True	proportional gain
Ti	Real	20.0	True	True	True	True	reset time
Td	Real	0.0	True	True	True	True	derivative time
TdFiltRatio	Real	0.2	True	True	True	True	filter coefficient for derivative part
PWeighting	Real	1.0	True	True	True	True	weighthing of proportional part in direct, feedback path
DWeighting	Real	1.0	True	True	True	True	weighthing of derivative part in direct, feedback path
Cycle	Real	1.0	True	True	True	True	PID Controller cycle time

PID_PWM and PID_Output / PLC_1 [CPU 1512C-1 PN] / PLC data types / System data types

PID_CompactSelfTune

PID_CompactSelfTune Properties

General

Name	PID_CompactSelfTune	Number	1139	Type	UDT	Language	
-------------	---------------------	---------------	------	-------------	-----	-----------------	--

Numbering

Information

Title	data set for self tuning	Author		Comment		Family	
--------------	--------------------------	---------------	--	----------------	--	---------------	--

Version		User-defined ID	
----------------	--	------------------------	--

Name	Data type	Default value	Accessible from HMI/OPC UA/Web API	Writ-able from HMI/ OPC UA/ Web API	Visible in HMI engi-neering	Setpoint	Comment
▼ SUT	PID_Compact_SUT		True	True	True	True	data set for start up tuning
CalculateParams	Bool	false	True	True	True	False	recalculate control parameters with parameters of startup tuning
TuneRule	Int	0	True	True	True	True	tuning rule for SUT (0-CHR PID,1-CHR PI)
State	Int	0	True	False	True	False	current phase of start up tuning
▼ TIR	PID_Compact_TIR		True	True	True	True	data set for tuning in run
RunIn	Bool	false	True	True	True	False	activate run in setpoint without controlling
CalculateParams	Bool	false	True	True	True	False	recalculate control parameters with parameters of tuning in run
TuneRule	Int	0	True	True	True	True	tuning rule for TIR (0-2-A PID auto,fast,slow;3-ZN PID;4-ZN PI;5-ZN P)
State	Int	0	True	False	True	False	current phase of tuning in run

PID_PWM and PID_Output / PLC_1 [CPU 1512C-1 PN] / PLC data types / System data types

PID_GradientEstimation

PID_GradientEstimation Properties

General

Name	PID_GradientEstimation	Number	1508	Type	UDT	Language	
-------------	------------------------	---------------	------	-------------	-----	-----------------	--

Numbering

Information

Title	structure for gradient estimation	Author		Comment		Family	
--------------	-----------------------------------	---------------	--	----------------	--	---------------	--

Version		User-defined ID	
----------------	--	------------------------	--

Name	Data type	Default value	Accessible from HMI/OPC UA/Web API	Writ-able from HMI/OPC UA/ Web API	Visible in HMI engineering	Setpoint	Comment

PID_PWM and PID_Output / PLC_1 [CPU 1512C-1 PN] / PLC data types / System data types

PID_GradientParams

PID_GradientParams Properties

General

Name	PID_GradientParams	Number	1511	Type	UDT	Language	
-------------	--------------------	---------------	------	-------------	-----	-----------------	--

Numbering

Information

Title	dataset of parameters for gradient estimation	Author		Comment		Family	
--------------	---	---------------	--	----------------	--	---------------	--

Version		User-defined ID	
----------------	--	------------------------	--

Name	Data type	Default value	Accessible from HMI/OPC UA/Web API	Writ-able from HMI/OPC UA/ Web API	Visible in HMI engineering	Setpoint	Comment

PID_PWM and PID_Output / PLC_1 [CPU 1512C-1 PN] / PLC data types / System data types

PID_StandardDeviation

PID_StandardDeviation Properties

General

Name	PID_StandardDeviation	Number	1509	Type	UDT	Language	
-------------	-----------------------	---------------	------	-------------	-----	-----------------	--

Numbering

Information

Title	data for estimation of deviance	Author		Comment		Family	
--------------	---------------------------------	---------------	--	----------------	--	---------------	--

Version		User-defined ID	
----------------	--	------------------------	--

Name	Data type	Default value	Accessible from HMI/OPC UA/Web API	Writ-able from HMI/OPC UA/ Web API	Visible in HMI engineering	Setpoint	Comment

PID_PWM and PID_Output / PLC_1 [CPU 1512C-1 PN] / PLC data types / System data types

PID_Compact_SUT

PID_Compact_SUT Properties

General

Name	PID_Compact_SUT	Number	1142	Type	UDT	Language	
-------------	-----------------	---------------	------	-------------	-----	-----------------	--

Numbering

Information

Title	data set for start up tuning	Author		Comment		Family	
--------------	------------------------------	---------------	--	----------------	--	---------------	--

Version		User-defined ID	
----------------	--	------------------------	--

Name	Data type	Default value	Accessible from HMI/OPC UA/Web API	Writ-able from HMI/ OPC UA/ Web API	Visible in HMI engi-neering	Setpoint	Comment
CalculateParams	Bool	false	True	True	True	False	recalculate control parameters with parameters of startup tuning
TuneRule	Int	0	True	True	True	True	tuning rule for SUT (0-CHR PID,1-CHR PI)
State	Int	0	True	False	True	False	current phase of start up tuning

PID_PWM and PID_Output / PLC_1 [CPU 1512C-1 PN] / PLC data types / System data types

PID_Compact_TIR

PID_Compact_TIR Properties

General

Name	PID_Compact_TIR	Number	1143	Type	UDT	Language	
-------------	-----------------	---------------	------	-------------	-----	-----------------	--

Numbering

Information

Title	data set for tuning in run	Author		Comment		Family	
--------------	----------------------------	---------------	--	----------------	--	---------------	--

Version		User-defined ID	
----------------	--	------------------------	--

Name	Data type	Default value	Accessible from HMI/OPC UA/Web API	Writ-able from HMI/ OPC UA/ Web API	Visible in HMI engi-neering	Setpoint	Comment
RunIn	Bool	false	True	True	True	False	activate run in setpoint without controlling
CalculateParams	Bool	false	True	True	True	False	recalculate control parameters with parameters of tuning in run
TuneRule	Int	0	True	True	True	True	tuning rule for TIR (0-2-A PID auto,fast,slow;3-ZN PID;4-ZN PI;5-ZN P)
State	Int	0	True	False	True	False	current phase of tuning in run

PID_PWM and PID_Output / PLC_1 [CPU 1512C-1 PN] / PLC data types / System data types

PID_CompactControl

PID_CompactControl Properties

General

Name	PID_CompactControl	Number	1144	Type	UDT	Language	
-------------	--------------------	---------------	------	-------------	-----	-----------------	--

Numbering

Information

Title	data for controlling part	Author		Comment		Family	
--------------	---------------------------	---------------	--	----------------	--	---------------	--

Version		User-defined ID	
----------------	--	------------------------	--

Name	Data type	Default value	Accessible from HMI/OPC UA/Web API	Writ-able from HMI/ OPC UA/ Web API	Visible in HMI engi-neering	Setpoint	Comment
PIDInit	Bool	false	True	True	True	False	initialization of controller
IntegralSum	Real	0.0	True	True	True	False	signal of integral part

PID_PWM and PID_Output / PLC_1 [CPU 1512C-1 PN] / PLC data types / System data types

PID_CompactRetain

PID_CompactRetain Properties

General

Name	PID_CompactRetain	Number	1145	Type	UDT	Language	
-------------	-------------------	---------------	------	-------------	-----	-----------------	--

Numbering

Information

Title	retain data	Author		Comment		Family	
--------------	-------------	---------------	--	----------------	--	---------------	--

Version		User-defined ID	
----------------	--	------------------------	--

Name	Data type	Default value	Accessible from HMI/OPC UA/Web API	Writ-able from HMI/ OPC UA/ Web API	Visible in HMI engi-neering	Setpoint	Comment
▼ CtrlParams	PID_CompactControlPar-ams		True	True	True	True	actual parameter set
Gain	Real	1.0	True	True	True	True	proportional gain
Ti	Real	20.0	True	True	True	True	reset time
Td	Real	0.0	True	True	True	True	derivative time
TdFiltRatio	Real	0.2	True	True	True	True	filter coefficient for derivative part
PWeighting	Real	1.0	True	True	True	True	weighting of proportional part in direct, feedback path
DWeighting	Real	1.0	True	True	True	True	weighting of derivative part in direct, feedback path
Cycle	Real	1.0	True	True	True	True	PID Controller cycle time

PID_PWM and PID_Output / PLC_1 [CPU 1512C-1 PN] / Watch and force tables

Force table

Name	Address	Display format	Force value	Comment
------	---------	----------------	-------------	---------

PID_PWM and PID_Output / PLC_1 [CPU 1512C-1 PN]

Traces

Name

PID_PWM and PID_Output / PLC_1 [CPU 1512C-1 PN] / Traces

Measurements

This folder is empty.

PID_PWM and PID_Output / PLC_1 [CPU 1512C-1 PN] / Traces

Combined measurements

Name

PID_PWM and PID_Output / PLC_1 [CPU 1512C-1 PN] / OPC UA communication

Server interfaces

This folder is empty.

PID_PWM and PID_Output / PLC_1 [CPU 1512C-1 PN] / OPC UA communication

Client interfaces

This folder is empty.

PID_PWM and PID_Output / PLC_1 [CPU 1512C-1 PN] / PLC supervisions & alarms

Supervisions

This folder is empty.

PID_PWM and PID_Output / PLC_1 [CPU 1512C-1 PN] / PLC supervisions & alarms



PLC alarms

PLC alarms



No entries

PID_PWM and PID_Output / PLC_1 [CPU 1512C-1 PN] / PLC supervisions & alarms

System alarms

System alarms			
Name	 SDIAG_ALCAT_SUBMODUL_MSG_0002	Type	PLC alarm
ID	1	Location	PLC_1
Alarm text	Error: @1W%t#7W@ @5W%t#7W@ @6W%t#257K@ / @6W%t#258K@.@6W%t#259K@ @6W%t#262K@ @6W%t#263K@	Info text	Short name: @6W%t#260K@ Order number: @6W%t#265K@
Alarm class	No Acknowledgement	Acknowledgment	False
Information only	True	Priority	0
Report	False	Created by	System diagnostics
Date created	8/13/2023 2:50 PM	Last change	8/13/2023 2:50 PM
Group ID	0	Additional text 1	PLC_1
Additional text 2		Additional text 3	
Additional text 4		Additional text 5	
Additional text 6		Additional text 7	
Additional text 8		Additional text 9	
Name	 SDIAG_ALCAT_MODUL_MSG_0003	Type	PLC alarm
ID	2	Location	PLC_1
Alarm text	Error: @1W%t#7W@ @5W%t#7W@ @6W%t#257K@ / @6W%t#258K@ @6W%t#262K@ @6W%t#263K@	Info text	Short name: @6W%t#260K@ Order number: @6W%t#265K@
Alarm class	No Acknowledgement	Acknowledgment	False
Information only	True	Priority	0
Report	False	Created by	System diagnostics
Date created	8/13/2023 2:50 PM	Last change	8/13/2023 2:50 PM
Group ID	0	Additional text 1	PLC_1
Additional text 2		Additional text 3	
Additional text 4		Additional text 5	
Additional text 6		Additional text 7	
Additional text 8		Additional text 9	
Name	 SDIAG_ALCAT_RACK_MSG_0004	Type	PLC alarm
ID	3	Location	PLC_1
Alarm text	Error: @1W%t#7W@ @5W%t#7W@ @6W%t#257K@ @6W%t#262K@ @6W%t#263K@	Info text	Short name: @6W%t#260K@ Order number: @6W%t#265K@
Alarm class	No Acknowledgement	Acknowledgment	False
Information only	True	Priority	0
Report	False	Created by	System diagnostics
Date created	8/13/2023 2:50 PM	Last change	8/13/2023 2:50 PM
Group ID	0	Additional text 1	PLC_1
Additional text 2		Additional text 3	
Additional text 4		Additional text 5	
Additional text 6		Additional text 7	
Additional text 8		Additional text 9	
Name	 SDIAG_ALCAT_DEVICE_MSG_0005	Type	PLC alarm
ID	4	Location	PLC_1
Alarm text	Error: @1W%t#7W@ @5W%t#7W@ @6W%t#257K@ @6W%t#262K@ @6W%t#263K@ @8W%t#7W@	Info text	Short name: @6W%t#260K@ Order number: @6W%t#265K@
Alarm class	No Acknowledgement	Acknowledgment	False
Information only	True	Priority	0
Report	False	Created by	System diagnostics
Date created	8/13/2023 2:50 PM	Last change	8/13/2023 2:50 PM
Group ID	0	Additional text 1	PLC_1
Additional text 2		Additional text 3	
Additional text 4		Additional text 5	
Additional text 6		Additional text 7	
Additional text 8		Additional text 9	
Name	 SDIAG_ALCAT_IOSYSTEM_MSG_0006	Type	PLC alarm
ID	5	Location	PLC_1
Alarm text	Error: @1W%t#7W@ @5W%t#7W@ @6W%t#276K@ @6W%t#262K@ @6W%t#263K@ @8W%t#7W@	Info text	Short name: @6W%t#260K@ Order number: @6W%t#265K@
Alarm class	No Acknowledgement	Acknowledgment	False
Information only	True	Priority	0
Report	False	Created by	System diagnostics
Date created	8/13/2023 2:50 PM	Last change	8/13/2023 2:50 PM
Group ID	0	Additional text 1	PLC_1
Additional text 2		Additional text 3	
Additional text 4		Additional text 5	
Additional text 6		Additional text 7	
Additional text 8		Additional text 9	
Name	 SDIAG_ALCAT_CPU_OST_MSG_000D	Type	PLC alarm
ID	6	Location	PLC_1
Alarm text	CPU status message: @1W%t#7W@ @5W%t#7W@ @6W%t#257K@ / @6W%t#258K@ @6W%t#262K@ @6W%t#263K@ @8W%t#7W@	Info text	Short name: @6W%t#260K@ Order number: @6W%t#265K@
Alarm class	No Acknowledgement	Acknowledgment	False
Information only	True	Priority	0
Report	False	Created by	System diagnostics
Date created	8/13/2023 2:50 PM	Last change	8/13/2023 2:50 PM
Group ID	0	Additional text 1	PLC_1
Additional text 2		Additional text 3	
Additional text 4		Additional text 5	
Additional text 6		Additional text 7	





Instrumentation Tools

Totally Integrated Automation Portal			
Additional text 8		Additional text 9	
Name	 SDIAG_ALCAT_CPU_INFO_MSG_000F	Type	PLC alarm
ID	7	Location	PLC_1
Alarm text	CPU info: @1W%t#7W@ @5W%t#7W@ @6W%t#257K@ / @6W%t#258K@ @6W%t#262K@ @6W%t#263K@ @8W%t#7W@	Info text	Short name: @6W%t#260K@ Order number: @6W%t#265K@
Alarm class	No Acknowledgement	Acknowledgment	False
Information only	True	Priority	0
Report	False	Created by	System diagnostics
Date created	8/13/2023 2:50 PM	Last change	8/13/2023 2:50 PM
Group ID	0	Additional text 1	PLC_1
Additional text 2		Additional text 3	
Additional text 4		Additional text 5	
Additional text 6		Additional text 7	
Additional text 8		Additional text 9	
Name	 SDIAG_ALCAT_CPU_ERR_MSG_0010	Type	PLC alarm
ID	8	Location	PLC_1
Alarm text	CPU error: @1W%t#7W@ @5W%t#7W@ @6W%t#257K@ / @6W%t#258K@ @6W%t#262K@ @6W%t#263K@ @8W%t#7W@	Info text	Short name: @6W%t#260K@ Order number: @6W%t#265K@
Alarm class	No Acknowledgement	Acknowledgment	False
Information only	True	Priority	0
Report	False	Created by	System diagnostics
Date created	8/13/2023 2:50 PM	Last change	8/13/2023 2:50 PM
Group ID	0	Additional text 1	PLC_1
Additional text 2		Additional text 3	
Additional text 4		Additional text 5	
Additional text 6		Additional text 7	
Additional text 8		Additional text 9	
Name	 SDIAG_ALCAT_CPU_MD_MSG_0011	Type	PLC alarm
ID	9	Location	PLC_1
Alarm text	CPU maintenance demanded: @1W%t#7W@ @6W%t#257K@ / @5W%t#7W@ @6W%t#258K@ @6W%t#262K@ @6W%t#263K@ @8W%t#7W@	Info text	Short name: @6W%t#260K@ Order number: @6W%t#265K@
Alarm class	No Acknowledgement	Acknowledgment	False
Information only	True	Priority	0
Report	False	Created by	System diagnostics
Date created	8/13/2023 2:50 PM	Last change	8/13/2023 2:50 PM
Group ID	0	Additional text 1	PLC_1
Additional text 2		Additional text 3	
Additional text 4		Additional text 5	
Additional text 6		Additional text 7	
Additional text 8		Additional text 9	
Name	 SDIAG_ALCAT_CPU_MR_MSG1_0012	Type	PLC alarm
ID	10	Location	PLC_1
Alarm text	CPU maintenance required: @1W%t#7W@ @6W%t#257K@ / @5W%t#7W@ @6W%t#258K@ @6W%t#262K@ @6W%t#263K@ @8W%t#7W@	Info text	Short name: @6W%t#260K@ Order number: @6W%t#265K@
Alarm class	No Acknowledgement	Acknowledgment	False
Information only	True	Priority	0
Report	False	Created by	System diagnostics
Date created	8/13/2023 2:50 PM	Last change	8/13/2023 2:50 PM
Group ID	0	Additional text 1	PLC_1
Additional text 2		Additional text 3	
Additional text 4		Additional text 5	
Additional text 6		Additional text 7	
Additional text 8		Additional text 9	
Name	 SDIAG_ALCAT_CPU_TMPERR_MSG_0013	Type	PLC alarm
ID	11	Location	PLC_1
Alarm text	Temporary CPU error: @1W%t#7W@ @5W%t#7W@ @6W%t#257K@ / @6W%t#258K@ @6W%t#262K@ @6W%t#263K@ @8W%t#7W@	Info text	Short name: @6W%t#260K@ Order number: @6W%t#265K@
Alarm class	No Acknowledgement	Acknowledgment	False
Information only	True	Priority	0
Report	False	Created by	System diagnostics
Date created	8/13/2023 2:50 PM	Last change	8/13/2023 2:50 PM
Group ID	0	Additional text 1	PLC_1
Additional text 2		Additional text 3	
Additional text 4		Additional text 5	
Additional text 6		Additional text 7	
Additional text 8		Additional text 9	
Name	 SDIAG_ALCAT_CH_ERR_MSG_0015	Type	PLC alarm
ID	12	Location	PLC_1
Alarm text	Error: @1W%t#7W@ on @8W%t#280K@ @6W%t#257K@ / @6W%t#258K@ @6W%t#259K@ @6W%t#262K@ @6W%t#263K@	Info text	Short name: @6W%t#260K@ Order number: @6W%t#265K@
Alarm class	No Acknowledgement	Acknowledgment	False
Information only	True	Priority	0
Report	False	Created by	System diagnostics
Date created	8/13/2023 2:50 PM	Last change	8/13/2023 2:50 PM
Group ID	0	Additional text 1	PLC_1
Additional text 2		Additional text 3	
Additional text 4		Additional text 5	
Additional text 6		Additional text 7	
Additional text 8		Additional text 9	

Instrumentation Tools

Totally Integrated Automation Portal			
Name	 SDIAG_ALCAT_ECH_ERR_MSG_0016	Type	PLC alarm
ID	13	Location	PLC_1
Alarm text	Error: @1W%t#7W@ - @5W%t#7W@ on @8W%t#280K@ @6W%t#257K@ / @6W%t#258K@.@6W%t#259K@ @6W%t#262K@ @6W%t#263K@	Info text	Short name: @6W%t#260K@ Order number: @6W%t#265K@
Alarm class	No Acknowledgement	Acknowledgment	False
Information only	True	Priority	0
Report	False	Created by	System diagnostics
Date created	8/13/2023 2:50 PM	Last change	8/13/2023 2:50 PM
Group ID	0	Additional text 1	PLC_1
Additional text 2		Additional text 3	
Additional text 4		Additional text 5	
Additional text 6		Additional text 7	
Additional text 8		Additional text 9	
Name	 SDIAG_ALCAT_CH_MD_MSG_0018	Type	PLC alarm
ID	14	Location	PLC_1
Alarm text	Maintenance demanded:@1W%t#7W@ on @8W%t#280K@ @6W%t#257K@ / @6W%t#258K@.@6W%t#259K@ @6W%t#262K@ @6W%t#263K@	Info text	Short name: @6W%t#260K@ Order number: @6W%t#265K@
Alarm class	No Acknowledgement	Acknowledgment	False
Information only	True	Priority	0
Report	False	Created by	System diagnostics
Date created	8/13/2023 2:50 PM	Last change	8/13/2023 2:50 PM
Group ID	0	Additional text 1	PLC_1
Additional text 2		Additional text 3	
Additional text 4		Additional text 5	
Additional text 6		Additional text 7	
Additional text 8		Additional text 9	
Name	 SDIAG_ALCAT_ECH_MD_MSG_0019	Type	PLC alarm
ID	15	Location	PLC_1
Alarm text	Maintenance demanded:@1W%t#7W@ - @5W%t#7W@ on @8W%t#280K@ @6W%t#257K@ / @6W%t#258K@.@6W%t#259K@ @6W%t#262K@ @6W%t#263K@	Info text	Short name: @6W%t#260K@ Order number: @6W%t#265K@
Alarm class	No Acknowledgement	Acknowledgment	False
Information only	True	Priority	0
Report	False	Created by	System diagnostics
Date created	8/13/2023 2:50 PM	Last change	8/13/2023 2:50 PM
Group ID	0	Additional text 1	PLC_1
Additional text 2		Additional text 3	
Additional text 4		Additional text 5	
Additional text 6		Additional text 7	
Additional text 8		Additional text 9	
Name	 SDIAG_ALCAT_CH_MR_MSG_001B	Type	PLC alarm
ID	16	Location	PLC_1
Alarm text	Maintenance required:@1W%t#7W@ on @8W%t#280K@ @6W%t#257K@ / @6W%t#258K@.@6W%t#259K@ @6W%t#262K@ @6W%t#263K@	Info text	Short name: @6W%t#260K@ Order number: @6W%t#265K@
Alarm class	No Acknowledgement	Acknowledgment	False
Information only	True	Priority	0
Report	False	Created by	System diagnostics
Date created	8/13/2023 2:50 PM	Last change	8/13/2023 2:50 PM
Group ID	0	Additional text 1	PLC_1
Additional text 2		Additional text 3	
Additional text 4		Additional text 5	
Additional text 6		Additional text 7	
Additional text 8		Additional text 9	
Name	 SDIAG_ALCAT_ECH_MR_MSG_001C	Type	PLC alarm
ID	17	Location	PLC_1
Alarm text	Maintenance required:@1W%t#7W@ - @5W%t#7W@ on @8W%t#280K@ @6W%t#257K@ / @6W%t#258K@.@6W%t#259K@ @6W%t#262K@ @6W%t#263K@	Info text	Short name: @6W%t#260K@ Order number: @6W%t#265K@
Alarm class	No Acknowledgement	Acknowledgment	False
Information only	True	Priority	0
Report	False	Created by	System diagnostics
Date created	8/13/2023 2:50 PM	Last change	8/13/2023 2:50 PM
Group ID	0	Additional text 1	PLC_1
Additional text 2		Additional text 3	
Additional text 4		Additional text 5	
Additional text 6		Additional text 7	
Additional text 8		Additional text 9	
Name	 SDIAG_ALCAT_SUB_ERR_MSG_001E	Type	PLC alarm
ID	18	Location	PLC_1
Alarm text	Error: @1W%t#7W@ @6W%t#257K@ / @6W%t#258K@.@6W%t#259K@ @6W%t#262K@ @6W%t#263K@	Info text	Short name: @6W%t#260K@ Order number: @6W%t#265K@
Alarm class	No Acknowledgement	Acknowledgment	False
Information only	True	Priority	0
Report	False	Created by	System diagnostics
Date created	8/13/2023 2:50 PM	Last change	8/13/2023 2:50 PM
Group ID	0	Additional text 1	PLC_1
Additional text 2		Additional text 3	
Additional text 4		Additional text 5	
Additional text 6		Additional text 7	
Additional text 8		Additional text 9	

Instrumentation Tools

Totally Integrated Automation Portal			
Name	 SDIAG_ALCAT_ESUB_ERR_MSG_001F	Type	PLC alarm
ID	19	Location	PLC_1
Alarm text	Error: @1W%t#7W@ - @5W%t#7W@ @6W%t#257K@ / @6W%t#258K@.@6W%t#259K@ @6W%t#262K@ @6W%t#263K@	Info text	Short name: @6W%t#260K@ Order number: @6W%t#265K@
Alarm class	No Acknowledgement	Acknowledgment	False
Information only	True	Priority	0
Report	False	Created by	System diagnostics
Date created	8/13/2023 2:50 PM	Last change	8/13/2023 2:50 PM
Group ID	0	Additional text 1	PLC_1
Additional text 2		Additional text 3	
Additional text 4		Additional text 5	
Additional text 6		Additional text 7	
Additional text 8		Additional text 9	
Name	 SDIAG_ALCAT_SUB_MD_MSG_0021	Type	PLC alarm
ID	20	Location	PLC_1
Alarm text	Maintenance demanded: @1W%t#7W@ @6W%t#257K@ / @6W%t#258K@.@6W%t#259K@ @6W%t#262K@ @6W%t#263K@	Info text	Short name: @6W%t#260K@ Order number: @6W%t#265K@
Alarm class	No Acknowledgement	Acknowledgment	False
Information only	True	Priority	0
Report	False	Created by	System diagnostics
Date created	8/13/2023 2:50 PM	Last change	8/13/2023 2:50 PM
Group ID	0	Additional text 1	PLC_1
Additional text 2		Additional text 3	
Additional text 4		Additional text 5	
Additional text 6		Additional text 7	
Additional text 8		Additional text 9	
Name	 SDIAG_ALCAT_ESUB_MD_MSG_0022	Type	PLC alarm
ID	21	Location	PLC_1
Alarm text	Maintenance demanded: @1W%t#7W@ - @5W%t#7W@ @6W%t#257K@ / @6W%t#258K@.@6W%t#259K@ @6W%t#262K@ @6W%t#263K@	Info text	Short name: @6W%t#260K@ Order number: @6W%t#265K@
Alarm class	No Acknowledgement	Acknowledgment	False
Information only	True	Priority	0
Report	False	Created by	System diagnostics
Date created	8/13/2023 2:50 PM	Last change	8/13/2023 2:50 PM
Group ID	0	Additional text 1	PLC_1
Additional text 2		Additional text 3	
Additional text 4		Additional text 5	
Additional text 6		Additional text 7	
Additional text 8		Additional text 9	
Name	 SDIAG_ALCAT_SUB_MR_MSG_0024	Type	PLC alarm
ID	22	Location	PLC_1
Alarm text	Maintenance required: @1W%t#7W@ @6W%t#257K@ / @6W%t#258K@.@6W%t#259K@ @6W%t#262K@ @6W%t#263K@	Info text	Short name: @6W%t#260K@ Order number: @6W%t#265K@
Alarm class	No Acknowledgement	Acknowledgment	False
Information only	True	Priority	0
Report	False	Created by	System diagnostics
Date created	8/13/2023 2:50 PM	Last change	8/13/2023 2:50 PM
Group ID	0	Additional text 1	PLC_1
Additional text 2		Additional text 3	
Additional text 4		Additional text 5	
Additional text 6		Additional text 7	
Additional text 8		Additional text 9	
Name	 SDIAG_ALCAT_ESUB_MR_MSG_0025	Type	PLC alarm
ID	23	Location	PLC_1
Alarm text	Maintenance required: @1W%t#7W@ - @5W%t#7W@ @6W%t#257K@ / @6W%t#258K@.@6W%t#259K@ @6W%t#262K@ @6W%t#263K@	Info text	Short name: @6W%t#260K@ Order number: @6W%t#265K@
Alarm class	No Acknowledgement	Acknowledgment	False
Information only	True	Priority	0
Report	False	Created by	System diagnostics
Date created	8/13/2023 2:50 PM	Last change	8/13/2023 2:50 PM
Group ID	0	Additional text 1	PLC_1
Additional text 2		Additional text 3	
Additional text 4		Additional text 5	
Additional text 6		Additional text 7	
Additional text 8		Additional text 9	
Name	 SDIAG_ALCAT_CONFIG_INFO_0028	Type	PLC alarm
ID	24	Location	PLC_1
Alarm text	Info: @1W%t#7W@ - @5W%t#7W@ @6W%t#257K@ @6W%t#262K@ @6W%t#263K@ @8W%t#7W@	Info text	Short name: @6W%t#260K@ Order number: @6W%t#265K@
Alarm class	No Acknowledgement	Acknowledgment	False
Information only	True	Priority	0
Report	False	Created by	System diagnostics
Date created	8/13/2023 2:50 PM	Last change	8/13/2023 2:50 PM
Group ID	0	Additional text 1	PLC_1
Additional text 2		Additional text 3	
Additional text 4		Additional text 5	
Additional text 6		Additional text 7	
Additional text 8		Additional text 9	
Name	 SDIAG_ALCAT_CONFIG_REPORT_0029	Type	PLC alarm
ID	25	Location	PLC_1







Instrumentation Tools

Totally Integrated Automation Portal			
Alarm text	Info: @1W%t#7W@ - @5W%t#7W@ @6W%t#257K@ / @6W%t#258K@ @6W%t#262K@ @6W%t#263K@	Info text	Short name: @6W%t#260K@ Order number: @6W%t#265K@
Alarm class	No Acknowledgement	Acknowledgment	False
Information only	True	Priority	0
Report	False	Created by	System diagnostics
Date created	8/13/2023 2:50 PM	Last change	8/13/2023 2:50 PM
Group ID	0	Additional text 1	PLC_1
Additional text 2		Additional text 3	
Additional text 4		Additional text 5	
Additional text 6		Additional text 7	
Additional text 8		Additional text 9	
Name	 SDIAG_ALCAT_SECU_EV_MSG_005E	Type	PLC alarm
ID	26	Location	PLC_1
Alarm text	Security event: @1W%t#7W@ @5W%t#7W@ @6W%t#258K@ @6W%t#262K@ @6W%t#263K@ @8W%t#7W@	Info text	Short name: @6W%t#260K@ Order number: @6W%t#265K@
Alarm class	No Acknowledgement	Acknowledgment	False
Information only	True	Priority	0
Report	False	Created by	Security
Date created	8/13/2023 2:50 PM	Last change	8/13/2023 2:50 PM
Group ID	0	Additional text 1	PLC_1
Additional text 2		Additional text 3	
Additional text 4		Additional text 5	
Additional text 6		Additional text 7	
Additional text 8		Additional text 9	
Name	 SDIAG_ALCAT_SECU_EV_INFO_005F	Type	PLC alarm
ID	27	Location	PLC_1
Alarm text	Security information: @1W%t#7W@ @5W%t#7W@ @6W%t#258K@ @6W%t#262K@ @6W%t#263K@ @8W%t#7W@	Info text	Short name: @6W%t#260K@ Order number: @6W%t#265K@
Alarm class	No Acknowledgement	Acknowledgment	False
Information only	True	Priority	0
Report	False	Created by	Security
Date created	8/13/2023 2:50 PM	Last change	8/13/2023 2:50 PM
Group ID	0	Additional text 1	PLC_1
Additional text 2		Additional text 3	
Additional text 4		Additional text 5	
Additional text 6		Additional text 7	
Additional text 8		Additional text 9	
Name	 SDIAG_ALCAT_USER_MSG_0080	Type	PLC alarm
ID	28	Location	PLC_1
Alarm text	User message: @1W%t#2W@	Info text	Short name: @6W%t#260K@ Order number: @6W%t#265K@
Alarm class	No Acknowledgement	Acknowledgment	False
Information only	True	Priority	0
Report	False	Created by	System diagnostics
Date created	8/13/2023 2:50 PM	Last change	8/13/2023 2:50 PM
Group ID	0	Additional text 1	PLC_1
Additional text 2		Additional text 3	
Additional text 4		Additional text 5	
Additional text 6		Additional text 7	
Additional text 8		Additional text 9	
Name	 SDIAG_ALCAT_PLC_MSG_00FF	Type	PLC alarm
ID	29	Location	PLC_1
Alarm text	PLC notification: @1W%t#7W@ @5W%t#7W@ @6W%t#256K@ @6W%t#262K@ @6W%t#263K@	Info text	Short name: @6W%t#260K@ Order number: @6W%t#265K@
Alarm class	No Acknowledgement	Acknowledgment	False
Information only	True	Priority	0
Report	False	Created by	System diagnostics
Date created	8/13/2023 2:50 PM	Last change	8/13/2023 2:50 PM
Group ID	0	Additional text 1	PLC_1
Additional text 2		Additional text 3	
Additional text 4		Additional text 5	
Additional text 6		Additional text 7	
Additional text 8		Additional text 9	
Name	 SDIAG_ALCAT_SUBMODUL_MSG_0102	Type	PLC alarm
ID	30	Location	PLC_1
Alarm text	Error: @1W%t#7W@ @5W%t#7W@ @6W%t#257K@ / @6W%t#258K@ @6W%t#259K@ @6W%t#262K@ @6W%t#263K@	Info text	Short name: @6W%t#260K@ Order number: @6W%t#265K@
Alarm class	No Acknowledgement	Acknowledgment	False
Information only	False	Priority	0
Report	False	Created by	System diagnostics
Date created	8/13/2023 2:50 PM	Last change	8/13/2023 2:50 PM
Group ID	0	Additional text 1	PLC_1
Additional text 2		Additional text 3	
Additional text 4		Additional text 5	
Additional text 6		Additional text 7	
Additional text 8		Additional text 9	
Name	 SDIAG_ALCAT_MODUL_MSG_0103	Type	PLC alarm
ID	31	Location	PLC_1
Alarm text	Error: @1W%t#7W@ @5W%t#7W@ @6W%t#257K@ / @6W%t#258K@ @6W%t#262K@ @6W%t#263K@	Info text	Short name: @6W%t#260K@ Order number: @6W%t#265K@
Alarm class	No Acknowledgement	Acknowledgment	False
Information only	False	Priority	0

Instrumentation Tools

Totally Integrated Automation Portal			
Report	False	Created by	System diagnostics
Date created	8/13/2023 2:50 PM	Last change	8/13/2023 2:50 PM
Group ID	0	Additional text 1	PLC_1
Additional text 2		Additional text 3	
Additional text 4		Additional text 5	
Additional text 6		Additional text 7	
Additional text 8		Additional text 9	
Name	 SDIAG_ALCAT_RACK_MSG_0104	Type	PLC alarm
ID	32	Location	PLC_1
Alarm text	Error: @1W%t#7W@ @5W%t#7W@ @6W%t#257K@ @6W%t#262K@ @6W%t#263K@	Info text	Short name: @6W%t#260K@ Order number: @6W%t#265K@
Alarm class	No Acknowledgement	Acknowledgment	False
Information only	False	Priority	0
Report	False	Created by	System diagnostics
Date created	8/13/2023 2:50 PM	Last change	8/13/2023 2:50 PM
Group ID	0	Additional text 1	PLC_1
Additional text 2		Additional text 3	
Additional text 4		Additional text 5	
Additional text 6		Additional text 7	
Additional text 8		Additional text 9	
Name	 SDIAG_ALCAT_DEVICE_MSG_0105	Type	PLC alarm
ID	33	Location	PLC_1
Alarm text	Error: @1W%t#7W@ @5W%t#7W@ @6W%t#257K@ @6W%t#262K@ @6W%t#263K@ @8W%t#7W@	Info text	Short name: @6W%t#260K@ Order number: @6W%t#265K@
Alarm class	No Acknowledgement	Acknowledgment	False
Information only	False	Priority	0
Report	False	Created by	System diagnostics
Date created	8/13/2023 2:50 PM	Last change	8/13/2023 2:50 PM
Group ID	0	Additional text 1	PLC_1
Additional text 2		Additional text 3	
Additional text 4		Additional text 5	
Additional text 6		Additional text 7	
Additional text 8		Additional text 9	
Name	 SDIAG_ALCAT_IOSYSTEM_MSG_0106	Type	PLC alarm
ID	34	Location	PLC_1
Alarm text	Error: @1W%t#7W@ @5W%t#7W@ @6W%t#276K@ @6W%t#262K@ @6W%t#263K@ @8W%t#7W@	Info text	Short name: @6W%t#260K@ Order number: @6W%t#265K@
Alarm class	No Acknowledgement	Acknowledgment	False
Information only	False	Priority	0
Report	False	Created by	System diagnostics
Date created	8/13/2023 2:50 PM	Last change	8/13/2023 2:50 PM
Group ID	0	Additional text 1	PLC_1
Additional text 2		Additional text 3	
Additional text 4		Additional text 5	
Additional text 6		Additional text 7	
Additional text 8		Additional text 9	
Name	 SDIAG_ALCAT_CPU_OST_MSG_010D	Type	PLC alarm
ID	35	Location	PLC_1
Alarm text	CPU status message: @1W%t#7W@ @5W%t#7W@ @6W%t#257K@ / @6W%t#258K@ @6W%t#262K@ @6W%t#263K@ @8W%t#7W@	Info text	Short name: @6W%t#260K@ Order number: @6W%t#265K@
Alarm class	No Acknowledgement	Acknowledgment	False
Information only	False	Priority	0
Report	False	Created by	System diagnostics
Date created	8/13/2023 2:50 PM	Last change	8/13/2023 2:50 PM
Group ID	0	Additional text 1	PLC_1
Additional text 2		Additional text 3	
Additional text 4		Additional text 5	
Additional text 6		Additional text 7	
Additional text 8		Additional text 9	
Name	 SDIAG_ALCAT_CPU_ERR_MSG_0110	Type	PLC alarm
ID	36	Location	PLC_1
Alarm text	CPU error: @1W%t#7W@ @5W%t#7W@ @6W%t#257K@ / @6W%t#258K@ @6W%t#262K@ @6W%t#263K@ @8W%t#7W@	Info text	Short name: @6W%t#260K@ Order number: @6W%t#265K@
Alarm class	No Acknowledgement	Acknowledgment	False
Information only	False	Priority	0
Report	False	Created by	System diagnostics
Date created	8/13/2023 2:50 PM	Last change	8/13/2023 2:50 PM
Group ID	0	Additional text 1	PLC_1
Additional text 2		Additional text 3	
Additional text 4		Additional text 5	
Additional text 6		Additional text 7	
Additional text 8		Additional text 9	
Name	 SDIAG_ALCAT_CPU_MD_MSG_0111	Type	PLC alarm
ID	37	Location	PLC_1
Alarm text	CPU maintenance demanded: @1W%t#7W@ @6W%t#257K@ / @5W%t#7W@ @6W%t#258K@ @6W%t#262K@ @6W%t#263K@ @8W%t#7W@	Info text	Short name: @6W%t#260K@ Order number: @6W%t#265K@
Alarm class	No Acknowledgement	Acknowledgment	False
Information only	False	Priority	0
Report	False	Created by	System diagnostics
Date created	8/13/2023 2:50 PM	Last change	8/13/2023 2:50 PM
Group ID	0	Additional text 1	PLC_1
Additional text 2		Additional text 3	

Instrumentation Tools

Totally Integrated Automation Portal		
Additional text 4		Additional text 5
Additional text 6		Additional text 7
Additional text 8		Additional text 9
Name	 SDIAG_ALCAT_CPU_MR_MSG1_0112	Type
ID	38	Location
Alarm text	CPU maintenance required: @1W%t#7W@ @6W%t#257K@ / @5W%t#7W@ @6W%t#258K@ @6W%t#262K@ @6W%t#263K@ @8W%t#7W@	Info text
Alarm class	No Acknowledgement	Acknowledgment
Information only	False	Priority
Report	False	Created by
Date created	8/13/2023 2:50 PM	Last change
Group ID	0	Additional text 1
Additional text 2		Additional text 3
Additional text 4		Additional text 5
Additional text 6		Additional text 7
Additional text 8		Additional text 9
Name	 SDIAG_ALCAT_CH_ERR_MSG_0115	Type
ID	39	Location
Alarm text	Error: @1W%t#7W@ on @8W%t#280K@ @6W%t#257K@ / @6W%t#258K@.@6W%t#259K@ @6W%t#262K@ @6W%t#263K@	Info text
Alarm class	No Acknowledgement	Acknowledgment
Information only	False	Priority
Report	False	Created by
Date created	8/13/2023 2:50 PM	Last change
Group ID	0	Additional text 1
Additional text 2		Additional text 3
Additional text 4		Additional text 5
Additional text 6		Additional text 7
Additional text 8		Additional text 9
Name	 SDIAG_ALCAT_ECH_ERR_MSG_0116	Type
ID	40	Location
Alarm text	Error: @1W%t#7W@ - @5W%t#7W@ on @8W%t#280K@ @6W%t#257K@ / @6W%t#258K@.@6W%t#259K@ @6W%t#262K@ @6W%t#263K@	Info text
Alarm class	No Acknowledgement	Acknowledgment
Information only	False	Priority
Report	False	Created by
Date created	8/13/2023 2:50 PM	Last change
Group ID	0	Additional text 1
Additional text 2		Additional text 3
Additional text 4		Additional text 5
Additional text 6		Additional text 7
Additional text 8		Additional text 9
Name	 SDIAG_ALCAT_CH_MD_MSG_0118	Type
ID	41	Location
Alarm text	Maintenance demanded:@1W%t#7W@ on @8W%t#280K@ @6W%t#257K@ / @6W%t#258K@.@6W%t#259K@ @6W%t#262K@ @6W%t#263K@	Info text
Alarm class	No Acknowledgement	Acknowledgment
Information only	False	Priority
Report	False	Created by
Date created	8/13/2023 2:50 PM	Last change
Group ID	0	Additional text 1
Additional text 2		Additional text 3
Additional text 4		Additional text 5
Additional text 6		Additional text 7
Additional text 8		Additional text 9
Name	 SDIAG_ALCAT_ECH_MD_MSG_0119	Type
ID	42	Location
Alarm text	Maintenance demanded:@1W%t#7W@ - @5W%t#7W@ on @8W%t#280K@ @6W%t#257K@ / @6W%t#258K@.@6W%t#259K@ @6W%t#262K@ @6W%t#263K@	Info text
Alarm class	No Acknowledgement	Acknowledgment
Information only	False	Priority
Report	False	Created by
Date created	8/13/2023 2:50 PM	Last change
Group ID	0	Additional text 1
Additional text 2		Additional text 3
Additional text 4		Additional text 5
Additional text 6		Additional text 7
Additional text 8		Additional text 9
Name	 SDIAG_ALCAT_CH_MR_MSG_011B	Type
ID	43	Location
Alarm text	Maintenance required:@1W%t#7W@ on @8W%t#280K@ @6W%t#257K@ / @6W%t#258K@.@6W%t#259K@ @6W%t#262K@ @6W%t#263K@	Info text
Alarm class	No Acknowledgement	Acknowledgment
Information only	False	Priority
Report	False	Created by
Date created	8/13/2023 2:50 PM	Last change
Group ID	0	Additional text 1
Additional text 2		Additional text 3
Additional text 4		Additional text 5

Instrumentation Tools

Totally Integrated Automation Portal			
Additional text 6		Additional text 7	
Additional text 8		Additional text 9	
Name	SDIAG_ALCAT_ECH_MR_MSG_011C	Type	PLC alarm
ID	44	Location	PLC_1
Alarm text	Maintenance required: @1W%t#7W@ - @5W%t#7W@ on @8W%t#280K@ @6W%t#257K@ / @6W%t#258K@.@6W%t#259K@ @6W%t#262K@ @6W%t#263K@	Info text	Short name: @6W%t#260K@ Order number: @6W%t#265K@
Alarm class	No Acknowledgement	Acknowledgment	False
Information only	False	Priority	0
Report	False	Created by	System diagnostics
Date created	8/13/2023 2:50 PM	Last change	8/13/2023 2:50 PM
Group ID	0	Additional text 1	PLC_1
Additional text 2		Additional text 3	
Additional text 4		Additional text 5	
Additional text 6		Additional text 7	
Additional text 8		Additional text 9	
Name	SDIAG_ALCAT_SUB_ERR_MSG_011E	Type	PLC alarm
ID	45	Location	PLC_1
Alarm text	Error: @1W%t#7W@ @6W%t#257K@ / @6W%t#258K@.@6W%t#259K@ @6W%t#262K@ @6W%t#263K@	Info text	Short name: @6W%t#260K@ Order number: @6W%t#265K@
Alarm class	No Acknowledgement	Acknowledgment	False
Information only	False	Priority	0
Report	False	Created by	System diagnostics
Date created	8/13/2023 2:50 PM	Last change	8/13/2023 2:50 PM
Group ID	0	Additional text 1	PLC_1
Additional text 2		Additional text 3	
Additional text 4		Additional text 5	
Additional text 6		Additional text 7	
Additional text 8		Additional text 9	
Name	SDIAG_ALCAT_ESUB_ERR_MSG_011F	Type	PLC alarm
ID	46	Location	PLC_1
Alarm text	Error: @1W%t#7W@ - @5W%t#7W@ @6W%t#257K@ / @6W%t#258K@.@6W%t#259K@ @6W%t#262K@ @6W%t#263K@	Info text	Short name: @6W%t#260K@ Order number: @6W%t#265K@
Alarm class	No Acknowledgement	Acknowledgment	False
Information only	False	Priority	0
Report	False	Created by	System diagnostics
Date created	8/13/2023 2:50 PM	Last change	8/13/2023 2:50 PM
Group ID	0	Additional text 1	PLC_1
Additional text 2		Additional text 3	
Additional text 4		Additional text 5	
Additional text 6		Additional text 7	
Additional text 8		Additional text 9	
Name	SDIAG_ALCAT_SUB_MD_MSG_0121	Type	PLC alarm
ID	47	Location	PLC_1
Alarm text	Maintenance demanded: @1W%t#7W@ @6W%t#257K@ / @6W%t#258K@.@6W%t#259K@ @6W%t#262K@ @6W%t#263K@	Info text	Short name: @6W%t#260K@ Order number: @6W%t#265K@
Alarm class	No Acknowledgement	Acknowledgment	False
Information only	False	Priority	0
Report	False	Created by	System diagnostics
Date created	8/13/2023 2:50 PM	Last change	8/13/2023 2:50 PM
Group ID	0	Additional text 1	PLC_1
Additional text 2		Additional text 3	
Additional text 4		Additional text 5	
Additional text 6		Additional text 7	
Additional text 8		Additional text 9	
Name	SDIAG_ALCAT_ESUB_MD_MSG_0122	Type	PLC alarm
ID	48	Location	PLC_1
Alarm text	Maintenance demanded: @1W%t#7W@ - @5W%t#7W@ @6W%t#257K@ / @6W%t#258K@.@6W%t#259K@ @6W%t#262K@ @6W%t#263K@	Info text	Short name: @6W%t#260K@ Order number: @6W%t#265K@
Alarm class	No Acknowledgement	Acknowledgment	False
Information only	False	Priority	0
Report	False	Created by	System diagnostics
Date created	8/13/2023 2:50 PM	Last change	8/13/2023 2:50 PM
Group ID	0	Additional text 1	PLC_1
Additional text 2		Additional text 3	
Additional text 4		Additional text 5	
Additional text 6		Additional text 7	
Additional text 8		Additional text 9	
Name	SDIAG_ALCAT_SUB_MR_MSG_0124	Type	PLC alarm
ID	49	Location	PLC_1
Alarm text	Maintenance required: @1W%t#7W@ @6W%t#257K@ / @6W%t#258K@.@6W%t#259K@ @6W%t#262K@ @6W%t#263K@	Info text	Short name: @6W%t#260K@ Order number: @6W%t#265K@
Alarm class	No Acknowledgement	Acknowledgment	False
Information only	False	Priority	0
Report	False	Created by	System diagnostics
Date created	8/13/2023 2:50 PM	Last change	8/13/2023 2:50 PM
Group ID	0	Additional text 1	PLC_1
Additional text 2		Additional text 3	
Additional text 4		Additional text 5	
Additional text 6		Additional text 7	

Instrumentation Tools

Totally Integrated Automation Portal			
Additional text 8		Additional text 9	
Name	SDIAG_ALCAT_ESUB_MR_MSG_0125	Type	PLC alarm
ID	50	Location	PLC_1
Alarm text	Maintenance required: @1W%t#7W@ - @5W%t#7W@ @6W%t#257K@ / @6W%t#258K@.@6W%t#259K@ @6W%t#262K@ @6W%t#263K@	Info text	Short name: @6W%t#260K@ Order number: @6W%t#265K@
Alarm class	No Acknowledgement	Acknowledgment	False
Information only	False	Priority	0
Report	False	Created by	System diagnostics
Date created	8/13/2023 2:50 PM	Last change	8/13/2023 2:50 PM
Group ID	0	Additional text 1	PLC_1
Additional text 2		Additional text 3	
Additional text 4		Additional text 5	
Additional text 6		Additional text 7	
Additional text 8		Additional text 9	
Name	SDIAG_ALCAT_CONFIG_INFO_0128	Type	PLC alarm
ID	51	Location	PLC_1
Alarm text	Info: @1W%t#7W@ - @5W%t#7W@ @6W%t#257K@ @6W%t#262K@ @6W%t#263K@ @8W%t#7W@	Info text	Short name: @6W%t#260K@ Order number: @6W%t#265K@
Alarm class	No Acknowledgement	Acknowledgment	False
Information only	False	Priority	0
Report	False	Created by	System diagnostics
Date created	8/13/2023 2:50 PM	Last change	8/13/2023 2:50 PM
Group ID	0	Additional text 1	PLC_1
Additional text 2		Additional text 3	
Additional text 4		Additional text 5	
Additional text 6		Additional text 7	
Additional text 8		Additional text 9	
Name	SDIAG_ALCAT_PLC_MSG_01FF	Type	PLC alarm
ID	52	Location	PLC_1
Alarm text	PLC notification: @1W%t#7W@ @5W%t#7W@ @6W%t#256K@ @6W%t#262K@ @6W%t#263K@	Info text	Short name: @6W%t#260K@ Order number: @6W%t#265K@
Alarm class	No Acknowledgement	Acknowledgment	False
Information only	False	Priority	0
Report	False	Created by	System diagnostics
Date created	8/13/2023 2:50 PM	Last change	8/13/2023 2:50 PM
Group ID	0	Additional text 1	PLC_1
Additional text 2		Additional text 3	
Additional text 4		Additional text 5	
Additional text 6		Additional text 7	
Additional text 8		Additional text 9	

PID_PWM and PID_Output / PLC_1 [CPU 1512C-1 PN]



PLC alarm text lists

This folder is empty.

Instrumentation Tools

Totally Integrated Automation Portal					
PID_PWM and PID_Output / PLC_1 [CPU 1512C-1 PN] / Local modules					
PLC_1 [CPU 1512C-1 PN]					
PLC_1					
General\Project information					
Name	PLC_1	Author	Mmuhamed	Comment	
Rack	0	Slot	1		
General\Catalog information					
Short designation	CPU 1512C-1 PN	Description	CPU with display; work memory 250 KB code and 1 MB data; 48 ns bit operation time; 4-stage protection concept, technology functions: motion control, closed-loop control, counting and measuring; tracing; Runtime options; for all PROFINET interfaces: transport protocol TCP/IP, secure Open User Communication, S7 communication, S7 routing, IP forwarding, Web server, DNS client, OPC UA: Server DA, Client DA, methods, companion specifications; PROFINET IO controller, supports RT/IRT, performance upgrade PROFINET V2.3, 2 ports, I-Device, MRP, MRPD, isochronous mode, Routing, runtime options; firmware V2.8 with DI32/DQ32, AI5/AQ2: Digital input module DI16 x DC24V, grouping 16; Digital output module DQ16 x DC24V/0.5A, grouping 16; Analog input module AI4 x U/I, AI 1xRTD, 16-bit, grouping 5; Analog output module AQ2 x U/I, 16-bit, grouping 2; 6 channels for counting and measuring with incremental encoders 24V (up to 100kHz); 4 channels for PTO, pulse width modulation, frequency output (up to 100kHz)	Article number	6ES7 512-1CK01-0AB0
Firmware version	V2.8				
General\Identification & Maintenance					
Plant designation		Location identifier		Installation date	2023-08-07 08:58:52.401
Additional information					
General\Checksums					
Text lists	FA 70 E8 75 1D 5A 8E 29	Software	C8 50 6F BC 2B E7 E9 2B		
PROFINET interface [X1]\General					
Name	PROFINET interface_1	Author	Mmuhamed	Comment	
PROFINET interface [X1]\Ethernet addresses\Interface networked with					
Subnet:	PN/IE_1				
PROFINET interface [X1]\Ethernet addresses\IP protocol					
IP configuration	Set IP address in the project	IP address:	192.168.0.1	Subnet mask:	255.255.255.0
Use router	False				
PROFINET interface [X1]\Ethernet addresses\PROFINET					
PROFINET device name is set directly at the device	False	Generate PROFINET device name automatically	True	PROFINET device name:	plc_1.profinet interface_1
Converted name:	plcxb1.profinetxinterfacexb1036c	Device number:	0		
PROFINET interface [X1]\Time-of-day synchronization\NTP mode					
Note	Time synchronization for all PROFINET interfaces take place within the settings for time synchronization of the PROFINET interface [X1].	Enable time synchronization via NTP server	False		IP addresses
Server 1	0.0.0.0	Server 2	0.0.0.0	Server 3	0.0.0.0
Server 4	0.0.0.0	Update interval	10s		
PROFINET interface [X1]\Operating mode					
IO controller	True	IO system		Device number	0
IO device	False				
PROFINET interface [X1]\Advanced options\Interface options					
Call the user program if communication errors occur	False	Support device replacement without exchangeable medium	True	Permit overwriting of device names of all assigned IO devices	False
Limit data infeed into the network	True	Use IEC V2.2 LLDP mode	False	Keep-Alive connection monitoring:	30s
PROFINET interface [X1]\Advanced options\Media redundancy					
MRP domain	mrpdomain-1	Media redundancy role:	Not device in the ring		
PROFINET interface [X1]\Advanced options\Real time settings\IO communication					
Send clock:	1.000ms				
PROFINET interface [X1]\Advanced options\Real time settings\Synchronization					
Sync domain:	Sync-Domain_1	Synchronization role:	Unsynchronized	RT class:	RT,IRT
PROFINET interface [X1]\Advanced options\Real time settings\Real time options					
Calculated bandwidth for cyclic IO data:	0.000ms	Calculated bandwidth for cyclic IO data:	0.000%		
PROFINET interface [X1]\Advanced options\Port [X1 P1 R]\General					
Name	Port_1	Author	Mmuhamed	Comment	
PROFINET interface [X1]\Advanced options\Port [X1 P1 R]\Port interconnection\Local port:					
Local port:	PLC_1\PROFINET interface_1 [X1]\Port_1 [X1 P1 R]	Medium:	Copper	Cable name:	---

Instrumentation Tools

Totally Integrated Automation Portal					
					
PROFINET interface [X1]\Advanced options\Port [X1 P1 R]\Port interconnection\Partner port:					
Monitoring of partner port is not possible	Alternative partners	False	Partner port:	Any partner	
PROFINET interface [X1]\Advanced options\Port [X1 P1 R]\Port options\Activate					
Activate this port for use	True				
PROFINET interface [X1]\Advanced options\Port [X1 P1 R]\Port options\Connection					
Transmission rate / duplex:	Automatic	Monitor	False	Enable autonegotiation	True
PROFINET interface [X1]\Advanced options\Port [X1 P1 R]\Port options\Boundaries					
End of detection of accessible devices	False	End of topology discovery	False	End of the sync domain	False
PROFINET interface [X1]\Advanced options\Port [X1 P2 R]\General					
Name	Port_2	Author	Mmuhamed	Comment	
PROFINET interface [X1]\Advanced options\Port [X1 P2 R]\Port interconnection\Local port:					
Local port:	PLC_1\PROFINET interface_1 [X1]\Port_2 [X1 P2 R]	Medium:	Copper	Cable name:	---
					
PROFINET interface [X1]\Advanced options\Port [X1 P2 R]\Port interconnection\Partner port:					
Monitoring of partner port is not possible	Alternative partners	False	Partner port:	Any partner	
PROFINET interface [X1]\Advanced options\Port [X1 P2 R]\Port options\Activate					
Activate this port for use	True				
PROFINET interface [X1]\Advanced options\Port [X1 P2 R]\Port options\Connection					
Transmission rate / duplex:	Automatic	Monitor	False	Enable autonegotiation	True
PROFINET interface [X1]\Advanced options\Port [X1 P2 R]\Port options\Boundaries					
End of detection of accessible devices	False	End of topology discovery	False	End of the sync domain	False
PROFINET interface [X1]\Web server access					
Note	The Web server must also be activated in the properties of the PLC.	Enable Web server via IP address of this interface	False		
AI 5/AQ 2 [X10]\General					
Name	AI 5/AQ 2_1	Comment			
AI 5/AQ 2 [X10]\Channel template\Inputs\Apply to all channels that use the template\Diagnostics					
Overflow	False	Underflow	False	Wire break	False
Current limit for wire break diagnostics					
AI 5/AQ 2 [X10]\Channel template\Inputs\Apply to all channels that use the template\Measuring					
Measurement type	Voltage	Measuring range	+/- 10V	Temperature coefficient	
Temperature unit	Smoothing		None		
AI 5/AQ 2 [X10]\Channel template\Outputs\Apply to all channels that use the template\Diagnostics					
Wire break	False	Short circuit to ground	False	Overflow	False
Underflow	False				
AI 5/AQ 2 [X10]\Channel template\Outputs\Apply to all channels that use the template\Output parameters					
Output type	Voltage	Output range	+/- 10V	Reaction to CPU STOP	Shutdown
Substitute value					
AI 5/AQ 2 [X10]\AI/AQ configuration\Value status (Quality Information)					
Value status	False				
AI 5/AQ 2 [X10]\Inputs\General\Measuring					
Interference frequency suppression	50Hz				
AI 5/AQ 2 [X10]\Inputs\Channel 0					
Parameter settings	Manual				
AI 5/AQ 2 [X10]\Inputs\Channel 0\Diagnostics					
Overflow	False	Underflow	False	Wire break	False
Current limit for wire break diagnostics					
AI 5/AQ 2 [X10]\Inputs\Channel 0\Measuring					
Measurement type	Voltage	Measuring range	+/- 10V	Temperature coefficient	
Temperature unit	Smoothing		None		
AI 5/AQ 2 [X10]\Inputs\Channel 0\Hardware interrupts					
High limit 1	Low limit 1		High limit 2		
Low limit 2					
AI 5/AQ 2 [X10]\Inputs\Channel 0\Hardware interrupts\					
Hardware interrupt high limit 1	0	RidPrefixFallingEdgeEvent	49272	Event name:	

Instrumentation Tools

Totally Integrated Automation Portal					
Hardware interrupt:	0	UpperLimitOne0	UpperLimitOne0	Channel number	0
HwEventTypeLimit1Overrun	4				
AI 5/AQ 2 [X10]\Inputs\Channel 0\Hardware interrupts\					
Hardware interrupt low limit 1	0	RidPrefixFallingEdgeEvent	49288	Event name:	
Hardware interrupt:	0	LowerLimitOne0	LowerLimitOne0	Channel number	0
HwEventTypeLimit1Underrun	3				
AI 5/AQ 2 [X10]\Inputs\Channel 0\Hardware interrupts\					
Hardware interrupt high limit 2	0	RidPrefixFallingEdgeEvent	49264	Event name:	
Hardware interrupt:	0	UpperLimitTwo0	UpperLimitTwo0	Channel number	0
HwEventTypeLimit2Overrun	6				
AI 5/AQ 2 [X10]\Inputs\Channel 0\Hardware interrupts\					
Hardware interrupt low limit 2	0	RidPrefixFallingEdgeEvent	49280	Event name:	
Hardware interrupt:	0	LowerLimitTwo0	LowerLimitTwo0	Channel number	0
HwEventTypeLimit2Underrun	5				
AI 5/AQ 2 [X10]\Inputs\Channel 1					
Parameter settings	Manual				
AI 5/AQ 2 [X10]\Inputs\Channel 1\Diagnostics					
Overflow	False	Underflow	False	Wire break	False
Current limit for wire break diagnostics					
AI 5/AQ 2 [X10]\Inputs\Channel 1\Measuring					
Measurement type	Voltage	Measuring range	+/- 10V	Temperature coefficient	
Temperature unit		Smoothing	None		
AI 5/AQ 2 [X10]\Inputs\Channel 1\Hardware interrupts					
High limit 1		Low limit 1		High limit 2	
Low limit 2					
AI 5/AQ 2 [X10]\Inputs\Channel 1\Hardware interrupts\					
Hardware interrupt high limit 1	0	RidPrefixFallingEdgeEvent	49273	Event name:	
Hardware interrupt:	0	UpperLimitOne1	UpperLimitOne1	Channel number	1
HwEventTypeLimit1Overrun	4				
AI 5/AQ 2 [X10]\Inputs\Channel 1\Hardware interrupts\					
Hardware interrupt low limit 1	0	RidPrefixFallingEdgeEvent	49289	Event name:	
Hardware interrupt:	0	LowerLimitOne1	LowerLimitOne1	Channel number	1
HwEventTypeLimit1Underrun	3				
AI 5/AQ 2 [X10]\Inputs\Channel 1\Hardware interrupts\					
Hardware interrupt high limit 2	0	RidPrefixFallingEdgeEvent	49265	Event name:	
Hardware interrupt:	0	UpperLimitTwo1	UpperLimitTwo1	Channel number	1
HwEventTypeLimit2Overrun	6				
AI 5/AQ 2 [X10]\Inputs\Channel 1\Hardware interrupts\					
Hardware interrupt low limit 2	0	RidPrefixFallingEdgeEvent	49281	Event name:	
Hardware interrupt:	0	LowerLimitTwo1	LowerLimitTwo1	Channel number	1
HwEventTypeLimit2Underrun	5				
AI 5/AQ 2 [X10]\Inputs\Channel 2					
Parameter settings	Manual				
AI 5/AQ 2 [X10]\Inputs\Channel 2\Diagnostics					
Overflow	False	Underflow	False	Wire break	False
Current limit for wire break diagnostics					
AI 5/AQ 2 [X10]\Inputs\Channel 2\Measuring					
Measurement type	Voltage	Measuring range	+/- 10V	Temperature coefficient	
Temperature unit		Smoothing	None		
AI 5/AQ 2 [X10]\Inputs\Channel 2\Hardware interrupts					
High limit 1		Low limit 1		High limit 2	
Low limit 2					
AI 5/AQ 2 [X10]\Inputs\Channel 2\Hardware interrupts\					
Hardware interrupt high limit 1	0	RidPrefixFallingEdgeEvent	49274	Event name:	
Hardware interrupt:	0	UpperLimitOne2	UpperLimitOne2	Channel number	2
HwEventTypeLimit1Overrun	4				
AI 5/AQ 2 [X10]\Inputs\Channel 2\Hardware interrupts\					
Hardware interrupt low limit 1	0	RidPrefixFallingEdgeEvent	49290	Event name:	
Hardware interrupt:	0	LowerLimitOne2	LowerLimitOne2	Channel number	2
HwEventTypeLimit1Underrun	3				
AI 5/AQ 2 [X10]\Inputs\Channel 2\Hardware interrupts\					
Hardware interrupt high limit 2	0	RidPrefixFallingEdgeEvent	49266	Event name:	
Hardware interrupt:	0	UpperLimitTwo2	UpperLimitTwo2	Channel number	2
HwEventTypeLimit2Overrun	6				

Instrumentation Tools

Totally Integrated Automation Portal					
AI 5/AQ 2 [X10]\Inputs\Channel 2\Hardware interrupts\					
Hardware interrupt low limit 2	0	RidPrefixFallingEdgeEvent	49282	Event name:	
Hardware interrupt:	0	LowerLimitTwo2	LowerLimitTwo2	Channel number	2
HwEventTypeLimit2Underrun	5				
AI 5/AQ 2 [X10]\Inputs\Channel 3					
Parameter settings	Manual				
AI 5/AQ 2 [X10]\Inputs\Channel 3\Diagnostics					
Overflow	False	Underflow	False	Wire break	False
Current limit for wire break diagnostics					
AI 5/AQ 2 [X10]\Inputs\Channel 3\Measuring					
Measurement type	Voltage	Measuring range	+/- 10V	Temperature coefficient	
Temperature unit		Smoothing	None		
AI 5/AQ 2 [X10]\Inputs\Channel 3\Hardware interrupts					
High limit 1		Low limit 1		High limit 2	
Low limit 2					
AI 5/AQ 2 [X10]\Inputs\Channel 3\Hardware interrupts\					
Hardware interrupt high limit 1	0	RidPrefixFallingEdgeEvent	49275	Event name:	
Hardware interrupt:	0	UpperLimitOne3	UpperLimitOne3	Channel number	3
HwEventTypeLimit1Overrun	4				
AI 5/AQ 2 [X10]\Inputs\Channel 3\Hardware interrupts\					
Hardware interrupt low limit 1	0	RidPrefixFallingEdgeEvent	49291	Event name:	
Hardware interrupt:	0	LowerLimitOne3	LowerLimitOne3	Channel number	3
HwEventTypeLimit1Underrun	3				
AI 5/AQ 2 [X10]\Inputs\Channel 3\Hardware interrupts\					
Hardware interrupt high limit 2	0	RidPrefixFallingEdgeEvent	49267	Event name:	
Hardware interrupt:	0	UpperLimitTwo3	UpperLimitTwo3	Channel number	3
HwEventTypeLimit2Overrun	6				
AI 5/AQ 2 [X10]\Inputs\Channel 3\Hardware interrupts\					
Hardware interrupt low limit 2	0	RidPrefixFallingEdgeEvent	49283	Event name:	
Hardware interrupt:	0	LowerLimitTwo3	LowerLimitTwo3	Channel number	3
HwEventTypeLimit2Underrun	5				
AI 5/AQ 2 [X10]\Inputs\Channel 4					
Parameter settings	Manual				
AI 5/AQ 2 [X10]\Inputs\Channel 4\Diagnostics					
Overflow	False	Underflow	False	Wire break	False
Current limit for wire break diagnostics					
AI 5/AQ 2 [X10]\Inputs\Channel 4\Measuring					
Measurement type	Resistance	Measuring range	600Ohm	Temperature coefficient	
Temperature unit		Smoothing	None		
AI 5/AQ 2 [X10]\Inputs\Channel 4\Hardware interrupts					
High limit 1		Low limit 1		High limit 2	
Low limit 2					
AI 5/AQ 2 [X10]\Inputs\Channel 4\Hardware interrupts\					
Hardware interrupt high limit 1	0	RidPrefixFallingEdgeEvent	49276	Event name:	
Hardware interrupt:	0	UpperLimitOne4	UpperLimitOne4	Channel number	4
HwEventTypeLimit1Overrun	4				
AI 5/AQ 2 [X10]\Inputs\Channel 4\Hardware interrupts\					
Hardware interrupt low limit 1	0	RidPrefixFallingEdgeEvent	49292	Event name:	
Hardware interrupt:	0	LowerLimitOne4	LowerLimitOne4	Channel number	4
HwEventTypeLimit1Underrun	3				
AI 5/AQ 2 [X10]\Inputs\Channel 4\Hardware interrupts\					
Hardware interrupt high limit 2	0	RidPrefixFallingEdgeEvent	49268	Event name:	
Hardware interrupt:	0	UpperLimitTwo4	UpperLimitTwo4	Channel number	4
HwEventTypeLimit2Overrun	6				
AI 5/AQ 2 [X10]\Inputs\Channel 4\Hardware interrupts\					
Hardware interrupt low limit 2	0	RidPrefixFallingEdgeEvent	49284	Event name:	
Hardware interrupt:	0	LowerLimitTwo4	LowerLimitTwo4	Channel number	4
HwEventTypeLimit2Underrun	5				
AI 5/AQ 2 [X10]\Outputs\Channel 0					
Parameter settings	Manual				
AI 5/AQ 2 [X10]\Outputs\Channel 0\Diagnostics					
Wire break	False	Short circuit to ground	False	Overflow	False
Underflow	False				
AI 5/AQ 2 [X10]\Outputs\Channel 0\Output					
Output type	Voltage	Output range	+/- 10V	Reaction to CPU STOP	Shutdown
Substitute value					

Instrumentation Tools

Totally Integrated Automation Portal					
AI 5/AQ 2 [X10]\Outputs\Channel 1					
Parameter settings	Manual				
AI 5/AQ 2 [X10]\Outputs\Channel 1\Diagnostics					
Wire break	False	Short circuit to ground	False	Overflow	False
Underflow	False				
AI 5/AQ 2 [X10]\Outputs\Channel 1\Output					
Output type	Voltage	Output range	+/- 10V	Reaction to CPU STOP	Shutdown
Substitute value					
AI 5/AQ 2 [X10]\I/O addresses\Input addresses					
Start address	0	End address	9	Organization block	0
Process image	0				
AI 5/AQ 2 [X10]\I/O addresses\Output addresses					
Start address	0	End address	3	Organization block	0
Process image	0				
DI 16/DQ 16 [X11]\General					
Name	DI 16/DQ 16_1	Comment			
DI 16/DQ 16 [X11]\Channel template\Inputs\Apply to all channels that use the template\Diagnostics					
No supply voltage L+	False				
DI 16/DQ 16 [X11]\Channel template\Inputs\Apply to all channels that use the template\Input parameters					
Input delay	3.2ms				
DI 16/DQ 16 [X11]\Channel template\Outputs\Apply to all channels that use the template\Diagnostics					
No supply voltage L+	False				
DI 16/DQ 16 [X11]\Channel template\Outputs\Apply to all channels that use the template\Output parameters					
Reaction to CPU STOP	Shutdown				
DI 16/DQ 16 [X11]\DI/DQ configuration\Value status (Quality Information)					
Value status	False				
DI 16/DQ 16 [X11]\Inputs\Channel 0					
Parameter settings	From template				
DI 16/DQ 16 [X11]\Inputs\Channel 0\Diagnostics					
No supply voltage L+	False				
DI 16/DQ 16 [X11]\Inputs\Channel 0\Input parameters					
Input delay	3.2ms				
DI 16/DQ 16 [X11]\Inputs\Channel 0\Hardware interrupts\					
Enable rising edge detection	0	RidPrefixRisingEdgeEvent	49152	Event name:	
Hardware interrupt:	0	Rising edge0	Rising edge0	Channel number	0
HwEventTypeRisingEdge	1				
DI 16/DQ 16 [X11]\Inputs\Channel 0\Hardware interrupts\					
Enable falling edge detection	0	RidPrefixFallingEdgeEvent	49280	Event name:	
Hardware interrupt:	0	Falling edge0	Falling edge0	Channel number	0
HwEventTypeFallingEdge	2				
DI 16/DQ 16 [X11]\Inputs\Channel 1					
Parameter settings	From template				
DI 16/DQ 16 [X11]\Inputs\Channel 1\Diagnostics					
No supply voltage L+	False				
DI 16/DQ 16 [X11]\Inputs\Channel 1\Input parameters					
Input delay	3.2ms				
DI 16/DQ 16 [X11]\Inputs\Channel 1\Hardware interrupts\					
Enable rising edge detection	0	RidPrefixRisingEdgeEvent	49153	Event name:	
Hardware interrupt:	0	Rising edge1	Rising edge1	Channel number	1
HwEventTypeRisingEdge	1				
DI 16/DQ 16 [X11]\Inputs\Channel 1\Hardware interrupts\					
Enable falling edge detection	0	RidPrefixFallingEdgeEvent	49281	Event name:	
Hardware interrupt:	0	Falling edge1	Falling edge1	Channel number	1
HwEventTypeFallingEdge	2				
DI 16/DQ 16 [X11]\Inputs\Channel 2					
Parameter settings	From template				
DI 16/DQ 16 [X11]\Inputs\Channel 2\Diagnostics					
No supply voltage L+	False				
DI 16/DQ 16 [X11]\Inputs\Channel 2\Input parameters					
Input delay	3.2ms				
DI 16/DQ 16 [X11]\Inputs\Channel 2\Hardware interrupts\					
Enable rising edge detection	0	RidPrefixRisingEdgeEvent	49154	Event name:	
Hardware interrupt:	0	Rising edge2	Rising edge2	Channel number	2
HwEventTypeRisingEdge	1				
DI 16/DQ 16 [X11]\Inputs\Channel 2\Hardware interrupts\					
Enable falling edge detection	0	RidPrefixFallingEdgeEvent	49282	Event name:	
Hardware interrupt:	0	Falling edge2	Falling edge2	Channel number	2
HwEventTypeFallingEdge	2				
DI 16/DQ 16 [X11]\Inputs\Channel 3					
Parameter settings	From template				
DI 16/DQ 16 [X11]\Inputs\Channel 3\Diagnostics					
No supply voltage L+	False				
DI 16/DQ 16 [X11]\Inputs\Channel 3\Input parameters					
Input delay	3.2ms				

Instrumentation Tools

Totally Integrated Automation Portal					
DI 16/DQ 16 [X11]\Inputs\Channel 3\Hardware interrupts\					
Enable rising edge detection	0	RidPrefixRisingEdgeEvent	49155	Event name:	
Hardware interrupt:	0	Rising edge3	Rising edge3	Channel number	3
HwEventTypeRisingEdge	1				
DI 16/DQ 16 [X11]\Inputs\Channel 3\Hardware interrupts\					
Enable falling edge detection	0	RidPrefixFallingEdgeEvent	49283	Event name:	
Hardware interrupt:	0	Falling edge3	Falling edge3	Channel number	3
HwEventTypeFallingEdge	2				
DI 16/DQ 16 [X11]\Inputs\Channel 4					
Parameter settings	From template				
DI 16/DQ 16 [X11]\Inputs\Channel 4\Diagnostics					
No supply voltage L+	False				
DI 16/DQ 16 [X11]\Inputs\Channel 4\Input parameters					
Input delay	3.2ms				
DI 16/DQ 16 [X11]\Inputs\Channel 4\Hardware interrupts\					
Enable rising edge detection	0	RidPrefixRisingEdgeEvent	49156	Event name:	
Hardware interrupt:	0	Rising edge4	Rising edge4	Channel number	4
HwEventTypeRisingEdge	1				
DI 16/DQ 16 [X11]\Inputs\Channel 4\Hardware interrupts\					
Enable falling edge detection	0	RidPrefixFallingEdgeEvent	49284	Event name:	
Hardware interrupt:	0	Falling edge4	Falling edge4	Channel number	4
HwEventTypeFallingEdge	2				
DI 16/DQ 16 [X11]\Inputs\Channel 5					
Parameter settings	From template				
DI 16/DQ 16 [X11]\Inputs\Channel 5\Diagnostics					
No supply voltage L+	False				
DI 16/DQ 16 [X11]\Inputs\Channel 5\Input parameters					
Input delay	3.2ms				
DI 16/DQ 16 [X11]\Inputs\Channel 5\Hardware interrupts\					
Enable rising edge detection	0	RidPrefixRisingEdgeEvent	49157	Event name:	
Hardware interrupt:	0	Rising edge5	Rising edge5	Channel number	5
HwEventTypeRisingEdge	1				
DI 16/DQ 16 [X11]\Inputs\Channel 5\Hardware interrupts\					
Enable falling edge detection	0	RidPrefixFallingEdgeEvent	49285	Event name:	
Hardware interrupt:	0	Falling edge5	Falling edge5	Channel number	5
HwEventTypeFallingEdge	2				
DI 16/DQ 16 [X11]\Inputs\Channel 6					
Parameter settings	From template				
DI 16/DQ 16 [X11]\Inputs\Channel 6\Diagnostics					
No supply voltage L+	False				
DI 16/DQ 16 [X11]\Inputs\Channel 6\Input parameters					
Input delay	3.2ms				
DI 16/DQ 16 [X11]\Inputs\Channel 6\Hardware interrupts\					
Enable rising edge detection	0	RidPrefixRisingEdgeEvent	49158	Event name:	
Hardware interrupt:	0	Rising edge6	Rising edge6	Channel number	6
HwEventTypeRisingEdge	1				
DI 16/DQ 16 [X11]\Inputs\Channel 6\Hardware interrupts\					
Enable falling edge detection	0	RidPrefixFallingEdgeEvent	49286	Event name:	
Hardware interrupt:	0	Falling edge6	Falling edge6	Channel number	6
HwEventTypeFallingEdge	2				
DI 16/DQ 16 [X11]\Inputs\Channel 7					
Parameter settings	From template				
DI 16/DQ 16 [X11]\Inputs\Channel 7\Diagnostics					
No supply voltage L+	False				
DI 16/DQ 16 [X11]\Inputs\Channel 7\Input parameters					
Input delay	3.2ms				
DI 16/DQ 16 [X11]\Inputs\Channel 7\Hardware interrupts\					
Enable rising edge detection	0	RidPrefixRisingEdgeEvent	49159	Event name:	
Hardware interrupt:	0	Rising edge7	Rising edge7	Channel number	7
HwEventTypeRisingEdge	1				
DI 16/DQ 16 [X11]\Inputs\Channel 7\Hardware interrupts\					
Enable falling edge detection	0	RidPrefixFallingEdgeEvent	49287	Event name:	
Hardware interrupt:	0	Falling edge7	Falling edge7	Channel number	7
HwEventTypeFallingEdge	2				
DI 16/DQ 16 [X11]\Inputs\Channel 8					
Parameter settings	From template				
DI 16/DQ 16 [X11]\Inputs\Channel 8\Diagnostics					
No supply voltage L+	False				

Instrumentation Tools

Totally Integrated Automation Portal						
DI 16/DQ 16 [X11]\Inputs\Channel 8\Input parameters						
Input delay	3.2ms					
DI 16/DQ 16 [X11]\Inputs\Channel 8\Hardware interrupts\						
Enable rising edge detection	0	RidPrefixRisingEdgeEvent	49160	Event name:		
Hardware interrupt:	0	Rising edge8	Rising edge8	Channel number	8	
HwEventTypeRisingEdge	1					
DI 16/DQ 16 [X11]\Inputs\Channel 8\Hardware interrupts\						
Enable falling edge detection	0	RidPrefixFallingEdgeEvent	49288	Event name:		
Hardware interrupt:	0	Falling edge8	Falling edge8	Channel number	8	
HwEventTypeFallingEdge	2					
DI 16/DQ 16 [X11]\Inputs\Channel 9						
Parameter settings	From template					
DI 16/DQ 16 [X11]\Inputs\Channel 9\Diagnostics						
No supply voltage L+	False					
DI 16/DQ 16 [X11]\Inputs\Channel 9\Input parameters						
Input delay	3.2ms					
DI 16/DQ 16 [X11]\Inputs\Channel 9\Hardware interrupts\						
Enable rising edge detection	0	RidPrefixRisingEdgeEvent	49161	Event name:		
Hardware interrupt:	0	Rising edge9	Rising edge9	Channel number	9	
HwEventTypeRisingEdge	1					
DI 16/DQ 16 [X11]\Inputs\Channel 9\Hardware interrupts\						
Enable falling edge detection	0	RidPrefixFallingEdgeEvent	49289	Event name:		
Hardware interrupt:	0	Falling edge9	Falling edge9	Channel number	9	
HwEventTypeFallingEdge	2					
DI 16/DQ 16 [X11]\Inputs\Channel 10						
Parameter settings	From template					
DI 16/DQ 16 [X11]\Inputs\Channel 10\Diagnostics						
No supply voltage L+	False					
DI 16/DQ 16 [X11]\Inputs\Channel 10\Input parameters						
Input delay	3.2ms					
DI 16/DQ 16 [X11]\Inputs\Channel 10\Hardware interrupts\						
Enable rising edge detection	0	RidPrefixRisingEdgeEvent	49162	Event name:		
Hardware interrupt:	0	Rising edge10	Rising edge10	Channel number	10	
HwEventTypeRisingEdge	1					
DI 16/DQ 16 [X11]\Inputs\Channel 10\Hardware interrupts\						
Enable falling edge detection	0	RidPrefixFallingEdgeEvent	49290	Event name:	0	
Hardware interrupt:	0	Falling edge10	Falling edge10	Channel number	10	
HwEventTypeFallingEdge	2					
DI 16/DQ 16 [X11]\Inputs\Channel 11						
Parameter settings	From template					
DI 16/DQ 16 [X11]\Inputs\Channel 11\Diagnostics						
No supply voltage L+	False					
DI 16/DQ 16 [X11]\Inputs\Channel 11\Input parameters						
Input delay	3.2ms					
DI 16/DQ 16 [X11]\Inputs\Channel 11\Hardware interrupts\						
Enable rising edge detection	0	RidPrefixRisingEdgeEvent	49163	Event name:		
Hardware interrupt:	0	Rising edge11	Rising edge11	Channel number	11	
HwEventTypeRisingEdge	1					
DI 16/DQ 16 [X11]\Inputs\Channel 11\Hardware interrupts\						
Enable falling edge detection	0	RidPrefixFallingEdgeEvent	49291	Event name:		
Hardware interrupt:	0	Falling edge11	Falling edge11	Channel number	11	
HwEventTypeFallingEdge	2					
DI 16/DQ 16 [X11]\Inputs\Channel 12						
Parameter settings	From template					
DI 16/DQ 16 [X11]\Inputs\Channel 12\Diagnostics						
No supply voltage L+	False					
DI 16/DQ 16 [X11]\Inputs\Channel 12\Input parameters						
Input delay	3.2ms					
DI 16/DQ 16 [X11]\Inputs\Channel 12\Hardware interrupts\						
Enable rising edge detection	0	RidPrefixRisingEdgeEvent	49164	Event name:		
Hardware interrupt:	0	Rising edge12	Rising edge12	Channel number	12	
HwEventTypeRisingEdge	1					
DI 16/DQ 16 [X11]\Inputs\Channel 12\Hardware interrupts\						
Enable falling edge detection	0	RidPrefixFallingEdgeEvent	49292	Event name:		
Hardware interrupt:	0	Falling edge12	Falling edge12	Channel number	12	
HwEventTypeFallingEdge	2					
DI 16/DQ 16 [X11]\Inputs\Channel 13						
Parameter settings	From template					

Instrumentation Tools

Totally Integrated Automation Portal		
DI 16/DQ 16 [X11]\Inputs\Channel 13\Diagnostics		
No supply voltage L+	False	
DI 16/DQ 16 [X11]\Inputs\Channel 13\Input parameters		
Input delay	3.2ms	
DI 16/DQ 16 [X11]\Inputs\Channel 13\Hardware interrupts		
Enable rising edge detection	0	RidPrefixRisingEdgeEvent 49165
Hardware interrupt:	0	Rising edge13 Rising edge13
HwEventTypeRisingEdge	1	Event name: Channel number 13
DI 16/DQ 16 [X11]\Inputs\Channel 13\Hardware interrupts		
Enable falling edge detection	0	RidPrefixFallingEdgeEvent 49293
Hardware interrupt:	0	Falling edge13 Falling edge13
HwEventTypeFallingEdge	2	Event name: Channel number 13
DI 16/DQ 16 [X11]\Inputs\Channel 14		
Parameter settings	From template	
DI 16/DQ 16 [X11]\Inputs\Channel 14\Diagnostics		
No supply voltage L+	False	
DI 16/DQ 16 [X11]\Inputs\Channel 14\Input parameters		
Input delay	3.2ms	
DI 16/DQ 16 [X11]\Inputs\Channel 14\Hardware interrupts		
Enable rising edge detection	0	RidPrefixRisingEdgeEvent 49166
Hardware interrupt:	0	Rising edge14 Rising edge14
HwEventTypeRisingEdge	1	Event name: Channel number 14
DI 16/DQ 16 [X11]\Inputs\Channel 14\Hardware interrupts		
Enable falling edge detection	0	RidPrefixFallingEdgeEvent 49294
Hardware interrupt:	0	Falling edge14 Falling edge14
HwEventTypeFallingEdge	2	Event name: Channel number 14
DI 16/DQ 16 [X11]\Inputs\Channel 15		
Parameter settings	From template	
DI 16/DQ 16 [X11]\Inputs\Channel 15\Diagnostics		
No supply voltage L+	False	
DI 16/DQ 16 [X11]\Inputs\Channel 15\Input parameters		
Input delay	3.2ms	
DI 16/DQ 16 [X11]\Inputs\Channel 15\Hardware interrupts		
Enable rising edge detection	0	RidPrefixRisingEdgeEvent 49167
Hardware interrupt:	0	Rising edge15 Rising edge15
HwEventTypeRisingEdge	1	Event name: Channel number 15
DI 16/DQ 16 [X11]\Inputs\Channel 15\Hardware interrupts		
Enable falling edge detection	0	RidPrefixFallingEdgeEvent 49295
Hardware interrupt:	0	Falling edge15 Falling edge15
HwEventTypeFallingEdge	2	Event name: Channel number 15
DI 16/DQ 16 [X11]\Outputs\Channel 0		
Parameter settings	From template	
DI 16/DQ 16 [X11]\Outputs\Channel 0\Diagnostics		
No supply voltage L+	False	
DI 16/DQ 16 [X11]\Outputs\Channel 0\Output parameters		
Reaction to CPU STOP	Shutdown	
DI 16/DQ 16 [X11]\Outputs\Channel 1		
Parameter settings	From template	
DI 16/DQ 16 [X11]\Outputs\Channel 1\Diagnostics		
No supply voltage L+	False	
DI 16/DQ 16 [X11]\Outputs\Channel 1\Output parameters		
Reaction to CPU STOP	Shutdown	
DI 16/DQ 16 [X11]\Outputs\Channel 2		
Parameter settings	From template	
DI 16/DQ 16 [X11]\Outputs\Channel 2\Diagnostics		
No supply voltage L+	False	
DI 16/DQ 16 [X11]\Outputs\Channel 2\Output parameters		
Reaction to CPU STOP	Shutdown	
DI 16/DQ 16 [X11]\Outputs\Channel 3		
Parameter settings	From template	
DI 16/DQ 16 [X11]\Outputs\Channel 3\Diagnostics		
No supply voltage L+	False	
DI 16/DQ 16 [X11]\Outputs\Channel 3\Output parameters		
Reaction to CPU STOP	Shutdown	
DI 16/DQ 16 [X11]\Outputs\Channel 4		
Parameter settings	From template	
DI 16/DQ 16 [X11]\Outputs\Channel 4\Diagnostics		
No supply voltage L+	False	
DI 16/DQ 16 [X11]\Outputs\Channel 4\Output parameters		
Reaction to CPU STOP	Shutdown	
DI 16/DQ 16 [X11]\Outputs\Channel 5		
Parameter settings	From template	
DI 16/DQ 16 [X11]\Outputs\Channel 5\Diagnostics		
No supply voltage L+	False	
DI 16/DQ 16 [X11]\Outputs\Channel 5\Output parameters		
Reaction to CPU STOP	Shutdown	

Instrumentation Tools

Totally Integrated Automation Portal					
DI 16/DQ 16 [X11]\Outputs\Channel 6					
Parameter settings	From template				
DI 16/DQ 16 [X11]\Outputs\Channel 6\Diagnostics					
No supply voltage L+	False				
DI 16/DQ 16 [X11]\Outputs\Channel 6\Output parameters					
Reaction to CPU STOP	Shutdown				
DI 16/DQ 16 [X11]\Outputs\Channel 7					
Parameter settings	From template				
DI 16/DQ 16 [X11]\Outputs\Channel 7\Diagnostics					
No supply voltage L+	False				
DI 16/DQ 16 [X11]\Outputs\Channel 7\Output parameters					
Reaction to CPU STOP	Shutdown				
DI 16/DQ 16 [X11]\Outputs\Channel 8					
Parameter settings	From template				
DI 16/DQ 16 [X11]\Outputs\Channel 8\Diagnostics					
No supply voltage L+	False				
DI 16/DQ 16 [X11]\Outputs\Channel 8\Output parameters					
Reaction to CPU STOP	Shutdown				
DI 16/DQ 16 [X11]\Outputs\Channel 9					
Parameter settings	From template				
DI 16/DQ 16 [X11]\Outputs\Channel 9\Diagnostics					
No supply voltage L+	False				
DI 16/DQ 16 [X11]\Outputs\Channel 9\Output parameters					
Reaction to CPU STOP	Shutdown				
DI 16/DQ 16 [X11]\Outputs\Channel 10					
Parameter settings	From template				
DI 16/DQ 16 [X11]\Outputs\Channel 10\Diagnostics					
No supply voltage L+	False				
DI 16/DQ 16 [X11]\Outputs\Channel 10\Output parameters					
Reaction to CPU STOP	Shutdown				
DI 16/DQ 16 [X11]\Outputs\Channel 11					
Parameter settings	From template				
DI 16/DQ 16 [X11]\Outputs\Channel 11\Diagnostics					
No supply voltage L+	False				
DI 16/DQ 16 [X11]\Outputs\Channel 11\Output parameters					
Reaction to CPU STOP	Shutdown				
DI 16/DQ 16 [X11]\Outputs\Channel 12					
Parameter settings	From template				
DI 16/DQ 16 [X11]\Outputs\Channel 12\Diagnostics					
No supply voltage L+	False				
DI 16/DQ 16 [X11]\Outputs\Channel 12\Output parameters					
Reaction to CPU STOP	Shutdown				
DI 16/DQ 16 [X11]\Outputs\Channel 13					
Parameter settings	From template				
DI 16/DQ 16 [X11]\Outputs\Channel 13\Diagnostics					
No supply voltage L+	False				
DI 16/DQ 16 [X11]\Outputs\Channel 13\Output parameters					
Reaction to CPU STOP	Shutdown				
DI 16/DQ 16 [X11]\Outputs\Channel 14					
Parameter settings	From template				
DI 16/DQ 16 [X11]\Outputs\Channel 14\Diagnostics					
No supply voltage L+	False				
DI 16/DQ 16 [X11]\Outputs\Channel 14\Output parameters					
Reaction to CPU STOP	Shutdown				
DI 16/DQ 16 [X11]\Outputs\Channel 15					
Parameter settings	From template				
DI 16/DQ 16 [X11]\Outputs\Channel 15\Diagnostics					
No supply voltage L+	False				
DI 16/DQ 16 [X11]\Outputs\Channel 15\Output parameters					
Reaction to CPU STOP	Shutdown				
DI 16/DQ 16 [X11]\I/O addresses\Input addresses					
Start address	10.0	End address	11.7	Organization block	0
Process image	0				
DI 16/DQ 16 [X11]\I/O addresses\Output addresses					
Start address	4.0	End address	5.7	Organization block	0
Process image	0				
DI 16/DQ 16 [X12]\General					
Name	DI 16/DQ 16_2	Comment			
DI 16/DQ 16 [X12]\Channel template\Inputs\Apply to all channels that use the template\Diagnostics					
No supply voltage L+	False				
DI 16/DQ 16 [X12]\Channel template\Inputs\Apply to all channels that use the template\Input parameters					
Input delay	3.2ms				
DI 16/DQ 16 [X12]\Channel template\Outputs\Apply to all channels that use the template\Diagnostics					
No supply voltage L+	False				
DI 16/DQ 16 [X12]\Channel template\Outputs\Apply to all channels that use the template\Output parameters					
Reaction to CPU STOP	Shutdown				
DI 16/DQ 16 [X12]\DI/DQ configuration\Value status (Quality Information)					
Value status	False				
DI 16/DQ 16 [X12]\Inputs\Channel 0					
Parameter settings	From template				
DI 16/DQ 16 [X12]\Inputs\Channel 0\Diagnostics					
No supply voltage L+	False				
DI 16/DQ 16 [X12]\Inputs\Channel 0\Input parameters					
Input delay	3.2ms				

Instrumentation Tools

Totally Integrated Automation Portal					
DI 16/DQ 16 [X12]\Inputs\Channel 0\Hardware interrupts\					
Enable rising edge detection	0	RidPrefixRisingEdgeEvent	49152	Event name:	
Hardware interrupt:	0	Rising edge0	Rising edge0	Channel number	0
HwEventTypeRisingEdge	1				
DI 16/DQ 16 [X12]\Inputs\Channel 0\Hardware interrupts\					
Enable falling edge detection	0	RidPrefixFallingEdgeEvent	49280	Event name:	
Hardware interrupt:	0	Falling edge0	Falling edge0	Channel number	0
HwEventTypeFallingEdge	2				
DI 16/DQ 16 [X12]\Inputs\Channel 1					
Parameter settings	From template				
DI 16/DQ 16 [X12]\Inputs\Channel 1\Diagnostics					
No supply voltage L+	False				
DI 16/DQ 16 [X12]\Inputs\Channel 1\Input parameters					
Input delay	3.2ms				
DI 16/DQ 16 [X12]\Inputs\Channel 1\Hardware interrupts\					
Enable rising edge detection	0	RidPrefixRisingEdgeEvent	49153	Event name:	
Hardware interrupt:	0	Rising edge1	Rising edge1	Channel number	1
HwEventTypeRisingEdge	1				
DI 16/DQ 16 [X12]\Inputs\Channel 1\Hardware interrupts\					
Enable falling edge detection	0	RidPrefixFallingEdgeEvent	49281	Event name:	
Hardware interrupt:	0	Falling edge1	Falling edge1	Channel number	1
HwEventTypeFallingEdge	2				
DI 16/DQ 16 [X12]\Inputs\Channel 2					
Parameter settings	From template				
DI 16/DQ 16 [X12]\Inputs\Channel 2\Diagnostics					
No supply voltage L+	False				
DI 16/DQ 16 [X12]\Inputs\Channel 2\Input parameters					
Input delay	3.2ms				
DI 16/DQ 16 [X12]\Inputs\Channel 2\Hardware interrupts\					
Enable rising edge detection	0	RidPrefixRisingEdgeEvent	49154	Event name:	
Hardware interrupt:	0	Rising edge2	Rising edge2	Channel number	2
HwEventTypeRisingEdge	1				
DI 16/DQ 16 [X12]\Inputs\Channel 2\Hardware interrupts\					
Enable falling edge detection	0	RidPrefixFallingEdgeEvent	49282	Event name:	
Hardware interrupt:	0	Falling edge2	Falling edge2	Channel number	2
HwEventTypeFallingEdge	2				
DI 16/DQ 16 [X12]\Inputs\Channel 3					
Parameter settings	From template				
DI 16/DQ 16 [X12]\Inputs\Channel 3\Diagnostics					
No supply voltage L+	False				
DI 16/DQ 16 [X12]\Inputs\Channel 3\Input parameters					
Input delay	3.2ms				
DI 16/DQ 16 [X12]\Inputs\Channel 3\Hardware interrupts\					
Enable rising edge detection	0	RidPrefixRisingEdgeEvent	49155	Event name:	
Hardware interrupt:	0	Rising edge3	Rising edge3	Channel number	3
HwEventTypeRisingEdge	1				
DI 16/DQ 16 [X12]\Inputs\Channel 3\Hardware interrupts\					
Enable falling edge detection	0	RidPrefixFallingEdgeEvent	49283	Event name:	
Hardware interrupt:	0	Falling edge3	Falling edge3	Channel number	3
HwEventTypeFallingEdge	2				
DI 16/DQ 16 [X12]\Inputs\Channel 4					
Parameter settings	From template				
DI 16/DQ 16 [X12]\Inputs\Channel 4\Diagnostics					
No supply voltage L+	False				
DI 16/DQ 16 [X12]\Inputs\Channel 4\Input parameters					
Input delay	3.2ms				
DI 16/DQ 16 [X12]\Inputs\Channel 4\Hardware interrupts\					
Enable rising edge detection	0	RidPrefixRisingEdgeEvent	49156	Event name:	
Hardware interrupt:	0	Rising edge4	Rising edge4	Channel number	4
HwEventTypeRisingEdge	1				
DI 16/DQ 16 [X12]\Inputs\Channel 4\Hardware interrupts\					
Enable falling edge detection	0	RidPrefixFallingEdgeEvent	49284	Event name:	
Hardware interrupt:	0	Falling edge4	Falling edge4	Channel number	4
HwEventTypeFallingEdge	2				
DI 16/DQ 16 [X12]\Inputs\Channel 5					
Parameter settings	From template				
DI 16/DQ 16 [X12]\Inputs\Channel 5\Diagnostics					
No supply voltage L+	False				

Instrumentation Tools

Totally Integrated Automation Portal					
DI 16/DQ 16 [X12]\Inputs\Channel 5\Input parameters					
Input delay	3.2ms				
DI 16/DQ 16 [X12]\Inputs\Channel 5\Hardware interrupts\					
Enable rising edge detection	0	RidPrefixRisingEdgeEvent	49157	Event name:	
Hardware interrupt:	0	Rising edge5	Rising edge5	Channel number	5
HwEventTypeRisingEdge	1				
DI 16/DQ 16 [X12]\Inputs\Channel 5\Hardware interrupts\					
Enable falling edge detection	0	RidPrefixFallingEdgeEvent	49285	Event name:	
Hardware interrupt:	0	Falling edge5	Falling edge5	Channel number	5
HwEventTypeFallingEdge	2				
DI 16/DQ 16 [X12]\Inputs\Channel 6					
Parameter settings	From template				
DI 16/DQ 16 [X12]\Inputs\Channel 6\Diagnostics					
No supply voltage L+	False				
DI 16/DQ 16 [X12]\Inputs\Channel 6\Input parameters					
Input delay	3.2ms				
DI 16/DQ 16 [X12]\Inputs\Channel 6\Hardware interrupts\					
Enable rising edge detection	0	RidPrefixRisingEdgeEvent	49158	Event name:	
Hardware interrupt:	0	Rising edge6	Rising edge6	Channel number	6
HwEventTypeRisingEdge	1				
DI 16/DQ 16 [X12]\Inputs\Channel 6\Hardware interrupts\					
Enable falling edge detection	0	RidPrefixFallingEdgeEvent	49286	Event name:	
Hardware interrupt:	0	Falling edge6	Falling edge6	Channel number	6
HwEventTypeFallingEdge	2				
DI 16/DQ 16 [X12]\Inputs\Channel 7					
Parameter settings	From template				
DI 16/DQ 16 [X12]\Inputs\Channel 7\Diagnostics					
No supply voltage L+	False				
DI 16/DQ 16 [X12]\Inputs\Channel 7\Input parameters					
Input delay	3.2ms				
DI 16/DQ 16 [X12]\Inputs\Channel 7\Hardware interrupts\					
Enable rising edge detection	0	RidPrefixRisingEdgeEvent	49159	Event name:	
Hardware interrupt:	0	Rising edge7	Rising edge7	Channel number	7
HwEventTypeRisingEdge	1				
DI 16/DQ 16 [X12]\Inputs\Channel 7\Hardware interrupts\					
Enable falling edge detection	0	RidPrefixFallingEdgeEvent	49287	Event name:	
Hardware interrupt:	0	Falling edge7	Falling edge7	Channel number	7
HwEventTypeFallingEdge	2				
DI 16/DQ 16 [X12]\Inputs\Channel 8					
Parameter settings	From template				
DI 16/DQ 16 [X12]\Inputs\Channel 8\Diagnostics					
No supply voltage L+	False				
DI 16/DQ 16 [X12]\Inputs\Channel 8\Input parameters					
Input delay	3.2ms				
DI 16/DQ 16 [X12]\Inputs\Channel 8\Hardware interrupts\					
Enable rising edge detection	0	RidPrefixRisingEdgeEvent	49160	Event name:	
Hardware interrupt:	0	Rising edge8	Rising edge8	Channel number	8
HwEventTypeRisingEdge	1				
DI 16/DQ 16 [X12]\Inputs\Channel 8\Hardware interrupts\					
Enable falling edge detection	0	RidPrefixFallingEdgeEvent	49288	Event name:	
Hardware interrupt:	0	Falling edge8	Falling edge8	Channel number	8
HwEventTypeFallingEdge	2				
DI 16/DQ 16 [X12]\Inputs\Channel 9					
Parameter settings	From template				
DI 16/DQ 16 [X12]\Inputs\Channel 9\Diagnostics					
No supply voltage L+	False				
DI 16/DQ 16 [X12]\Inputs\Channel 9\Input parameters					
Input delay	3.2ms				
DI 16/DQ 16 [X12]\Inputs\Channel 9\Hardware interrupts\					
Enable rising edge detection	0	RidPrefixRisingEdgeEvent	49161	Event name:	
Hardware interrupt:	0	Rising edge9	Rising edge9	Channel number	9
HwEventTypeRisingEdge	1				
DI 16/DQ 16 [X12]\Inputs\Channel 9\Hardware interrupts\					
Enable falling edge detection	0	RidPrefixFallingEdgeEvent	49289	Event name:	
Hardware interrupt:	0	Falling edge9	Falling edge9	Channel number	9
HwEventTypeFallingEdge	2				
DI 16/DQ 16 [X12]\Inputs\Channel 10					
Parameter settings	From template				

Instrumentation Tools

Totally Integrated Automation Portal					
DI 16/DQ 16 [X12]\Inputs\Channel 10\Diagnostics					
No supply voltage L+	False				
DI 16/DQ 16 [X12]\Inputs\Channel 10\Input parameters					
Input delay	3.2ms				
DI 16/DQ 16 [X12]\Inputs\Channel 10\Hardware interrupts\					
Enable rising edge detection	0	RidPrefixRisingEdgeEvent	49162	Event name:	
Hardware interrupt:	0	Rising edge10	Rising edge10	Channel number	10
HwEventTypeRisingEdge	1				
DI 16/DQ 16 [X12]\Inputs\Channel 10\Hardware interrupts\					
Enable falling edge detection	0	RidPrefixFallingEdgeEvent	49290	Event name:	0
Hardware interrupt:	0	Falling edge10	Falling edge10	Channel number	10
HwEventTypeFallingEdge	2				
DI 16/DQ 16 [X12]\Inputs\Channel 11					
Parameter settings	From template				
DI 16/DQ 16 [X12]\Inputs\Channel 11\Diagnostics					
No supply voltage L+	False				
DI 16/DQ 16 [X12]\Inputs\Channel 11\Input parameters					
Input delay	3.2ms				
DI 16/DQ 16 [X12]\Inputs\Channel 11\Hardware interrupts\					
Enable rising edge detection	0	RidPrefixRisingEdgeEvent	49163	Event name:	
Hardware interrupt:	0	Rising edge11	Rising edge11	Channel number	11
HwEventTypeRisingEdge	1				
DI 16/DQ 16 [X12]\Inputs\Channel 11\Hardware interrupts\					
Enable falling edge detection	0	RidPrefixFallingEdgeEvent	49291	Event name:	
Hardware interrupt:	0	Falling edge11	Falling edge11	Channel number	11
HwEventTypeFallingEdge	2				
DI 16/DQ 16 [X12]\Inputs\Channel 12					
Parameter settings	From template				
DI 16/DQ 16 [X12]\Inputs\Channel 12\Diagnostics					
No supply voltage L+	False				
DI 16/DQ 16 [X12]\Inputs\Channel 12\Input parameters					
Input delay	3.2ms				
DI 16/DQ 16 [X12]\Inputs\Channel 12\Hardware interrupts\					
Enable rising edge detection	0	RidPrefixRisingEdgeEvent	49164	Event name:	
Hardware interrupt:	0	Rising edge12	Rising edge12	Channel number	12
HwEventTypeRisingEdge	1				
DI 16/DQ 16 [X12]\Inputs\Channel 12\Hardware interrupts\					
Enable falling edge detection	0	RidPrefixFallingEdgeEvent	49292	Event name:	
Hardware interrupt:	0	Falling edge12	Falling edge12	Channel number	12
HwEventTypeFallingEdge	2				
DI 16/DQ 16 [X12]\Inputs\Channel 13					
Parameter settings	From template				
DI 16/DQ 16 [X12]\Inputs\Channel 13\Diagnostics					
No supply voltage L+	False				
DI 16/DQ 16 [X12]\Inputs\Channel 13\Input parameters					
Input delay	3.2ms				
DI 16/DQ 16 [X12]\Inputs\Channel 13\Hardware interrupts\					
Enable rising edge detection	0	RidPrefixRisingEdgeEvent	49165	Event name:	
Hardware interrupt:	0	Rising edge13	Rising edge13	Channel number	13
HwEventTypeRisingEdge	1				
DI 16/DQ 16 [X12]\Inputs\Channel 13\Hardware interrupts\					
Enable falling edge detection	0	RidPrefixFallingEdgeEvent	49293	Event name:	
Hardware interrupt:	0	Falling edge13	Falling edge13	Channel number	13
HwEventTypeFallingEdge	2				
DI 16/DQ 16 [X12]\Inputs\Channel 14					
Parameter settings	From template				
DI 16/DQ 16 [X12]\Inputs\Channel 14\Diagnostics					
No supply voltage L+	False				
DI 16/DQ 16 [X12]\Inputs\Channel 14\Input parameters					
Input delay	3.2ms				
DI 16/DQ 16 [X12]\Inputs\Channel 14\Hardware interrupts\					
Enable rising edge detection	0	RidPrefixRisingEdgeEvent	49166	Event name:	
Hardware interrupt:	0	Rising edge14	Rising edge14	Channel number	14
HwEventTypeRisingEdge	1				
DI 16/DQ 16 [X12]\Inputs\Channel 14\Hardware interrupts\					
Enable falling edge detection	0	RidPrefixFallingEdgeEvent	49294	Event name:	
Hardware interrupt:	0	Falling edge14	Falling edge14	Channel number	14
HwEventTypeFallingEdge	2				

Instrumentation Tools

Totally Integrated Automation Portal		
DI 16/DQ 16 [X12]\Inputs\Channel 15		
Parameter settings	From template	
DI 16/DQ 16 [X12]\Inputs\Channel 15\Diagnostics		
No supply voltage L+	False	
DI 16/DQ 16 [X12]\Inputs\Channel 15\Input parameters		
Input delay	3.2ms	
DI 16/DQ 16 [X12]\Inputs\Channel 15\Hardware interrupts\		
Enable rising edge detection	0	RidPrefixRisingEdgeEvent 49167
Hardware interrupt:	0	Rising edge15 Rising edge15
HwEventTypeRisingEdge	1	Channel number 15
DI 16/DQ 16 [X12]\Inputs\Channel 15\Hardware interrupts\		
Enable falling edge detection	0	RidPrefixFallingEdgeEvent 49295
Hardware interrupt:	0	Falling edge15 Falling edge15
HwEventTypeFallingEdge	2	Channel number 15
DI 16/DQ 16 [X12]\Outputs\Channel 0		
Parameter settings	From template	
DI 16/DQ 16 [X12]\Outputs\Channel 0\Diagnostics		
No supply voltage L+	False	
DI 16/DQ 16 [X12]\Outputs\Channel 0\Output parameters		
Reaction to CPU STOP	Shutdown	
DI 16/DQ 16 [X12]\Outputs\Channel 1		
Parameter settings	From template	
DI 16/DQ 16 [X12]\Outputs\Channel 1\Diagnostics		
No supply voltage L+	False	
DI 16/DQ 16 [X12]\Outputs\Channel 1\Output parameters		
Reaction to CPU STOP	Shutdown	
DI 16/DQ 16 [X12]\Outputs\Channel 2		
Parameter settings	From template	
DI 16/DQ 16 [X12]\Outputs\Channel 2\Diagnostics		
No supply voltage L+	False	
DI 16/DQ 16 [X12]\Outputs\Channel 2\Output parameters		
Reaction to CPU STOP	Shutdown	
DI 16/DQ 16 [X12]\Outputs\Channel 3		
Parameter settings	From template	
DI 16/DQ 16 [X12]\Outputs\Channel 3\Diagnostics		
No supply voltage L+	False	
DI 16/DQ 16 [X12]\Outputs\Channel 3\Output parameters		
Reaction to CPU STOP	Shutdown	
DI 16/DQ 16 [X12]\Outputs\Channel 4		
Parameter settings	From template	
DI 16/DQ 16 [X12]\Outputs\Channel 4\Diagnostics		
No supply voltage L+	False	
DI 16/DQ 16 [X12]\Outputs\Channel 4\Output parameters		
Reaction to CPU STOP	Shutdown	
DI 16/DQ 16 [X12]\Outputs\Channel 5		
Parameter settings	From template	
DI 16/DQ 16 [X12]\Outputs\Channel 5\Diagnostics		
No supply voltage L+	False	
DI 16/DQ 16 [X12]\Outputs\Channel 5\Output parameters		
Reaction to CPU STOP	Shutdown	
DI 16/DQ 16 [X12]\Outputs\Channel 6		
Parameter settings	From template	
DI 16/DQ 16 [X12]\Outputs\Channel 6\Diagnostics		
No supply voltage L+	False	
DI 16/DQ 16 [X12]\Outputs\Channel 6\Output parameters		
Reaction to CPU STOP	Shutdown	
DI 16/DQ 16 [X12]\Outputs\Channel 7		
Parameter settings	From template	
DI 16/DQ 16 [X12]\Outputs\Channel 7\Diagnostics		
No supply voltage L+	False	
DI 16/DQ 16 [X12]\Outputs\Channel 7\Output parameters		
Reaction to CPU STOP	Shutdown	
DI 16/DQ 16 [X12]\Outputs\Channel 8		
Parameter settings	From template	
DI 16/DQ 16 [X12]\Outputs\Channel 8\Diagnostics		
No supply voltage L+	False	
DI 16/DQ 16 [X12]\Outputs\Channel 8\Output parameters		
Reaction to CPU STOP	Shutdown	
DI 16/DQ 16 [X12]\Outputs\Channel 9		
Parameter settings	From template	
DI 16/DQ 16 [X12]\Outputs\Channel 9\Diagnostics		
No supply voltage L+	False	
DI 16/DQ 16 [X12]\Outputs\Channel 9\Output parameters		
Reaction to CPU STOP	Shutdown	
DI 16/DQ 16 [X12]\Outputs\Channel 10		
Parameter settings	From template	
DI 16/DQ 16 [X12]\Outputs\Channel 10\Diagnostics		
No supply voltage L+	False	
DI 16/DQ 16 [X12]\Outputs\Channel 10\Output parameters		
Reaction to CPU STOP	Shutdown	
DI 16/DQ 16 [X12]\Outputs\Channel 11		
Parameter settings	From template	

Instrumentation Tools

Totally Integrated Automation Portal					
DI 16/DQ 16 [X12]\Outputs\Channel 11\Diagnostics					
No supply voltage L+	False				
DI 16/DQ 16 [X12]\Outputs\Channel 11\Output parameters					
Reaction to CPU STOP	Shutdown				
DI 16/DQ 16 [X12]\Outputs\Channel 12					
Parameter settings	From template				
DI 16/DQ 16 [X12]\Outputs\Channel 12\Diagnostics					
No supply voltage L+	False				
DI 16/DQ 16 [X12]\Outputs\Channel 12\Output parameters					
Reaction to CPU STOP	Shutdown				
DI 16/DQ 16 [X12]\Outputs\Channel 13					
Parameter settings	From template				
DI 16/DQ 16 [X12]\Outputs\Channel 13\Diagnostics					
No supply voltage L+	False				
DI 16/DQ 16 [X12]\Outputs\Channel 13\Output parameters					
Reaction to CPU STOP	Shutdown				
DI 16/DQ 16 [X12]\Outputs\Channel 14					
Parameter settings	From template				
DI 16/DQ 16 [X12]\Outputs\Channel 14\Diagnostics					
No supply voltage L+	False				
DI 16/DQ 16 [X12]\Outputs\Channel 14\Output parameters					
Reaction to CPU STOP	Shutdown				
DI 16/DQ 16 [X12]\Outputs\Channel 15					
Parameter settings	From template				
DI 16/DQ 16 [X12]\Outputs\Channel 15\Diagnostics					
No supply voltage L+	False				
DI 16/DQ 16 [X12]\Outputs\Channel 15\Output parameters					
Reaction to CPU STOP	Shutdown				
DI 16/DQ 16 [X12]\I/O addresses\Input addresses					
Start address	12.0	End address	13.7	Organization block	0
Process image	0				
DI 16/DQ 16 [X12]\I/O addresses\Output addresses					
Start address	6.0	End address	7.7	Organization block	0
Process image	0				
High speed counters (HSC)\CPU 1511C compatibility					
Front connector assignment like CPU 1511C	False				
High speed counters (HSC)\HSC 1\General\Enable					
Activate this high-speed counter	False				
High speed counters (HSC)\HSC 1\General\Project information					
Name	HSC_1	Author	Mmuhamed	Comment	
High speed counters (HSC)\HSC 1\Channel 0\Operating mode					
Selection of operating mode	Operating with technology object "Counting and measurement"				
High speed counters (HSC)\HSC 1\Channel 0\Reaction to CPU STOP					
Reaction to CPU STOP	Output substitute value	Substitute value for DQ0	0	Substitute value for DQ1	0
High speed counters (HSC)\HSC 1\Channel 0\Diagnostic interrupts					
Enable diagnostic interrupts	False				
High speed counters (HSC)\HSC 1\Channel 0\Hardware interrupts\Hardware interrupt triggered by external events\					
New capture value available	0	RidPrefixCaptureEvent	49280	Event name	
Hardware interrupt	0	Capture value0	Capture value0	Channel number	0
HwEventTypeCapture	8				
High speed counters (HSC)\HSC 1\Channel 0\Hardware interrupts\Hardware interrupt triggered by external events\					
Synchronization of the counter by an external signal	0	RidPrefixSyncEvent	49296	Event name	
Hardware interrupt	0	Synchronization0	Synchronization0	Channel number	0
HwEventTypeSync	9				
High speed counters (HSC)\HSC 1\Channel 0\Hardware interrupts\Hardware interrupt triggered by external events\					
Gate start	0	RidPrefixGateStartEvent	49168	Event name	
Hardware interrupt	0	Gate start0	Gate start0	Channel number	0
HwEventTypeGateStart	1				
High speed counters (HSC)\HSC 1\Channel 0\Hardware interrupts\Hardware interrupt triggered by external events\					
Gate stop	0	RidPrefixGateStopEvent	49184	Event name	
Hardware interrupt	0	Gate stop0	Gate stop0	Channel number	0
HwEventTypeGateStop	2				
High speed counters (HSC)\HSC 1\Channel 0\Hardware interrupts\Hardware interrupt by counter value/position value\					
Overflow (high counting limit violated)	0	RidPrefixOverflowEvent	49200	Event name	
Hardware interrupt	0	Overflow0	Overflow0	Channel number	0
HwEventTypeOverflow	3				
High speed counters (HSC)\HSC 1\Channel 0\Hardware interrupts\Hardware interrupt by counter value/position value\					
Underflow (low counting limit violated)	0	RidPrefixUnderflowEvent	49216	Event name	
Hardware interrupt	0	Underflow0	Underflow0	Channel number	0
HwEventTypeUnderflow	4				

Instrumentation Tools

Totally Integrated Automation Portal					
High speed counters (HSC)\HSC 1\Channel 0\Hardware interrupts\Hardware interrupt by counter value/position value\					
Direction reversal	0	RidPrefixDirection-ChangedEvent	49312	Event name	
Hardware interrupt	0	Direction reversal0	Direction reversal0	Channel number	0
HwEventTypeDirectionChanged	10				
High speed counters (HSC)\HSC 1\Channel 0\Hardware interrupts\Hardware interrupt by counter value/position value\					
Zero crossing	0	RidPrefixZeroCrossingEvent	49264	Event name	
Hardware interrupt	0	Zero crossing0	Zero crossing0	Channel number	0
HwEventTypeZeroCrossing	7				
High speed counters (HSC)\HSC 1\Channel 0\Hardware interrupts\Hardware interrupt by counter value/position value\					
Comparison event for DQ0 occurred	0	RidPrefixCompare0Event	49232	Event name	
Hardware interrupt	0	Compare event DQ00	Compare event DQ00	Channel number	0
HwEventTypeCompare0	5				
High speed counters (HSC)\HSC 1\Channel 0\Hardware interrupts\Hardware interrupt by counter value/position value\					
Comparison event for DQ1 occurred	0	RidPrefixCompare1Event	49248	Event name	
Hardware interrupt	0	Compare event DQ10	Compare event DQ10	Channel number	0
HwEventTypeCompare1	6				
High speed counters (HSC)\HSC 1\Channel 0\Counter inputs\Specify input signals/encoder type					
Signal type	Pulse (A) and direction (B)		Invert direction	False	
High speed counters (HSC)\HSC 1\Channel 0\Counter inputs\Additional parameters					
Signal evaluation	Single	Filter frequency	100 kHz	Reaction to signal N	No reaction to signal N
High speed counters (HSC)\HSC 1\Channel 0\Counter behavior\Counting limits and start value					
High counting limit	2147483647	Start value	0	Low counting limit	-2147483648
High speed counters (HSC)\HSC 1\Channel 0\Counter behavior\Counter behavior at limits and gate start					
Reaction to violation of a counting limit	Continue counting	Reset when counting limit is violated	To opposite counting limit	Reaction to gate start	Continue with current value
High speed counters (HSC)\HSC 1\Channel 0\Behavior of inputs\Behavior of DI0\Function of DI0					
Set function of DI	Digital input without function	HSC DI0	None	Input delay	No input for DI0 selected
High speed counters (HSC)\HSC 1\Channel 0\Behavior of inputs\Behavior of DI1\Function of DI1					
Set function of DI	Digital input without function	HSC DI1	None	Input delay	No input for DI1 selected
High speed counters (HSC)\HSC 1\Channel 0\Behavior of outputs\Behavior of DQ0\Function of DQ0					
Set output	Between comparison value 0 and high limit	Comparison value 0	0	Comparison value 1	10
Count direction	In both directions	Pulse duration	500.0ms	Substitute value for DQ0	0
HSC DQ0	Only available via feedback interface				
High speed counters (HSC)\HSC 1\Channel 0\Behavior of outputs\Behavior of DQ1\Function of DQ1					
Set output	Between comparison value 1 and high limit	Comparison value 0	0	Comparison value 1	10
Count direction	In both directions	Pulse duration	500.0ms	Substitute value for DQ1	0
HSC DQ1	None				
High speed counters (HSC)\HSC 1\Channel 0\Hysteresis\Set hysteresis range					
Hysteresis (in increments)	0				
High speed counters (HSC)\HSC 1\Channel 0\Measured value\Specify measured value					
Measured variable	Frequency	Update time	10.000ms		
High speed counters (HSC)\HSC 1\Hardware inputs/outputs					
Pulse input (A)	X11, Clamp 1 (DI0 / %I10.0)	Direction input (B)	X11, Clamp 2 (DI1 / %I10.1)	Reset input (N)	None
HSC DI0	None	HSC DI1	None	HSC DQ0	Only available via feedback interface
HSC DQ1	None				
High speed counters (HSC)\HSC 1\I/O addresses\Input addresses					
Start address	14.0	End address	29.7	Organization block	0
Process image	0				
High speed counters (HSC)\HSC 1\I/O addresses\Output addresses					
Start address	8.0	End address	19.7	Organization block	0
Process image	0				
High speed counters (HSC)\HSC 2\General\Enable					
Activate this high-speed counter	False				
High speed counters (HSC)\HSC 2\General\Project information					
Name	HSC_2	Author	Mmuhamed	Comment	
High speed counters (HSC)\HSC 2\Channel 0\Operating mode					
Selection of operating mode	Operating with technology object "Counting and measurement"				
High speed counters (HSC)\HSC 2\Channel 0\Reaction to CPU STOP					
Reaction to CPU STOP	Output substitute value	Substitute value for DQ0	0	Substitute value for DQ1	0
High speed counters (HSC)\HSC 2\Channel 0\Diagnostic interrupts					
Enable diagnostic interrupts	False				
High speed counters (HSC)\HSC 2\Channel 0\Hardware interrupts\Hardware interrupt triggered by external events\					
New capture value available	0	RidPrefixCaptureEvent	49280	Event name	
Hardware interrupt	0	Capture value0	Capture value0	Channel number	0
HwEventTypeCapture	8				
High speed counters (HSC)\HSC 2\Channel 0\Hardware interrupts\Hardware interrupt triggered by external events\					
Synchronization of the counter by an external signal	0	RidPrefixSyncEvent	49296	Event name	
Hardware interrupt	0	Synchronization0	Synchronization0	Channel number	0
HwEventTypeSync	9				

Instrumentation Tools

Totally Integrated Automation Portal					
High speed counters (HSC)\HSC 2\Channel 0\Hardware interrupts\Hardware interrupt triggered by external events\					
Gate start	0	RidPrefixGateStartEvent	49168	Event name	
Hardware interrupt	0	Gate start0	Gate start0	Channel number	0
HwEventTypeGateStart	1				
High speed counters (HSC)\HSC 2\Channel 0\Hardware interrupts\Hardware interrupt triggered by external events\					
Gate stop	0	RidPrefixGateStopEvent	49184	Event name	
Hardware interrupt	0	Gate stop0	Gate stop0	Channel number	0
HwEventTypeGateStop	2				
High speed counters (HSC)\HSC 2\Channel 0\Hardware interrupts\Hardware interrupt by counter value/position value\					
Overflow (high counting limit violated)	0	RidPrefixOverflowEvent	49200	Event name	
Hardware interrupt	0	Overflow0	Overflow0	Channel number	0
HwEventTypeOverflow	3				
High speed counters (HSC)\HSC 2\Channel 0\Hardware interrupts\Hardware interrupt by counter value/position value\					
Underflow (low counting limit violated)	0	RidPrefixUnderflowEvent	49216	Event name	
Hardware interrupt	0	Underflow0	Underflow0	Channel number	0
HwEventTypeUnderflow	4				
High speed counters (HSC)\HSC 2\Channel 0\Hardware interrupts\Hardware interrupt by counter value/position value\					
Direction reversal	0	RidPrefixDirectionChangedEvent	49312	Event name	
Hardware interrupt	0	Direction reversal0	Direction reversal0	Channel number	0
HwEventTypeDirectionChanged	10				
High speed counters (HSC)\HSC 2\Channel 0\Hardware interrupts\Hardware interrupt by counter value/position value\					
Zero crossing	0	RidPrefixZeroCrossingEvent	49264	Event name	
Hardware interrupt	0	Zero crossing0	Zero crossing0	Channel number	0
HwEventTypeZeroCrossing	7				
High speed counters (HSC)\HSC 2\Channel 0\Hardware interrupts\Hardware interrupt by counter value/position value\					
Comparison event for DQ0 occurred	0	RidPrefixCompare0Event	49232	Event name	
Hardware interrupt	0	Compare event DQ00	Compare event DQ00	Channel number	0
HwEventTypeCompare0	5				
High speed counters (HSC)\HSC 2\Channel 0\Hardware interrupts\Hardware interrupt by counter value/position value\					
Comparison event for DQ1 occurred	0	RidPrefixCompare1Event	49248	Event name	
Hardware interrupt	0	Compare event DQ10	Compare event DQ10	Channel number	0
HwEventTypeCompare1	6				
High speed counters (HSC)\HSC 2\Channel 0\Counter inputs\Specify input signals/encoder type					
Signal type	Pulse (A) and direction (B)	Invert direction	False		
High speed counters (HSC)\HSC 2\Channel 0\Counter inputs\Additional parameters					
Signal evaluation	Single	Filter frequency	100 kHz	Reaction to signal N	No reaction to signal N
High speed counters (HSC)\HSC 2\Channel 0\Counter behavior\Counting limits and start value					
High counting limit	2147483647	Start value	0	Low counting limit	-2147483648
High speed counters (HSC)\HSC 2\Channel 0\Counter behavior\Counter behavior at limits and gate start					
Reaction to violation of a counting limit	Continue counting	Reset when counting limit is violated	To opposite counting limit	Reaction to gate start	Continue with current value
High speed counters (HSC)\HSC 2\Channel 0\Behavior of inputs\Behavior of DI0\Function of DI0					
Set function of DI	Digital input without function	HSC DI0	None	Input delay	No input for DI0 selected
High speed counters (HSC)\HSC 2\Channel 0\Behavior of inputs\Behavior of DI1\Function of DI1					
Set function of DI	Digital input without function	HSC DI1	None	Input delay	No input for DI1 selected
High speed counters (HSC)\HSC 2\Channel 0\Behavior of outputs\Behavior of DQ0\Function of DQ0					
Set output	Between comparison value 0 and high limit	Comparison value 0	0	Comparison value 1	10
Count direction	In both directions	Pulse duration	500.0ms	Substitute value for DQ0	0
HSC DQ0	Only available via feedback interface				
High speed counters (HSC)\HSC 2\Channel 0\Behavior of outputs\Behavior of DQ1\Function of DQ1					
Set output	Between comparison value 1 and high limit	Comparison value 0	0	Comparison value 1	10
Count direction	In both directions	Pulse duration	500.0ms	Substitute value for DQ1	0
HSC DQ1	None				
High speed counters (HSC)\HSC 2\Channel 0\Hysteresis\Set hysteresis range					
Hysteresis (in increments)	0				
High speed counters (HSC)\HSC 2\Channel 0\Measured value\Specify measured value					
Measured variable	Frequency	Update time	10.000ms		
High speed counters (HSC)\HSC 2\Hardware inputs/outputs					
Pulse input (A)	X11, Clamp 4 (DI3 / %I10.3)	Direction input (B)	X11, Clamp 5 (DI4 / %I10.4)	Reset input (N)	None
HSC DI0	None	HSC DI1	None	HSC DQ0	Only available via feedback interface
HSC DQ1	None				
High speed counters (HSC)\HSC 2\I/O addresses\Input addresses					
Start address	30.0	End address	45.7	Organization block	0
Process image	0				
High speed counters (HSC)\HSC 2\I/O addresses\Output addresses					
Start address	20.0	End address	31.7	Organization block	0
Process image	0				

Instrumentation Tools

Totally Integrated Automation Portal					
High speed counters (HSC)\HSC 3\General\Enable					
Activate this high-speed counter	False				
High speed counters (HSC)\HSC 3\General\Project information					
Name	HSC_3	Author	Mmuhammed	Comment	
High speed counters (HSC)\HSC 3\Channel 0\Operating mode					
Selection of operating mode	Operating with technology object "Counting and measurement"				
High speed counters (HSC)\HSC 3\Channel 0\Reaction to CPU STOP					
Reaction to CPU STOP	Output substitute value	Substitute value for DQ0	0	Substitute value for DQ1	0
High speed counters (HSC)\HSC 3\Channel 0\Diagnostic interrupts					
Enable diagnostic interrupts	False				
High speed counters (HSC)\HSC 3\Channel 0\Hardware interrupts\Hardware interrupt triggered by external events\					
New capture value available	0	RidPrefixCaptureEvent	49280	Event name	
Hardware interrupt	0	Capture value0	Capture value0	Channel number	0
HwEventTypeCapture	8				
High speed counters (HSC)\HSC 3\Channel 0\Hardware interrupts\Hardware interrupt triggered by external events\					
Synchronization of the counter by an external signal	0	RidPrefixSyncEvent	49296	Event name	
Hardware interrupt	0	Synchronization0	Synchronization0	Channel number	0
HwEventTypeSync	9				
High speed counters (HSC)\HSC 3\Channel 0\Hardware interrupts\Hardware interrupt triggered by external events\					
Gate start	0	RidPrefixGateStartEvent	49168	Event name	
Hardware interrupt	0	Gate start0	Gate start0	Channel number	0
HwEventTypeGateStart	1				
High speed counters (HSC)\HSC 3\Channel 0\Hardware interrupts\Hardware interrupt triggered by external events\					
Gate stop	0	RidPrefixGateStopEvent	49184	Event name	
Hardware interrupt	0	Gate stop0	Gate stop0	Channel number	0
HwEventTypeGateStop	2				
High speed counters (HSC)\HSC 3\Channel 0\Hardware interrupts\Hardware interrupt by counter value/position value\					
Overflow (high counting limit violated)	0	RidPrefixOverflowEvent	49200	Event name	
Hardware interrupt	0	Overflow0	Overflow0	Channel number	0
HwEventTypeOverflow	3				
High speed counters (HSC)\HSC 3\Channel 0\Hardware interrupts\Hardware interrupt by counter value/position value\					
Underflow (low counting limit violated)	0	RidPrefixUnderflowEvent	49216	Event name	
Hardware interrupt	0	Underflow0	Underflow0	Channel number	0
HwEventTypeUnderflow	4				
High speed counters (HSC)\HSC 3\Channel 0\Hardware interrupts\Hardware interrupt by counter value/position value\					
Direction reversal	0	RidPrefixDirectionChangedEvent	49312	Event name	
Hardware interrupt	0	Direction reversal0	Direction reversal0	Channel number	0
HwEventTypeDirectionChanged	10				
High speed counters (HSC)\HSC 3\Channel 0\Hardware interrupts\Hardware interrupt by counter value/position value\					
Zero crossing	0	RidPrefixZeroCrossingEvent	49264	Event name	
Hardware interrupt	0	Zero crossing0	Zero crossing0	Channel number	0
HwEventTypeZeroCrossing	7				
High speed counters (HSC)\HSC 3\Channel 0\Hardware interrupts\Hardware interrupt by counter value/position value\					
Comparison event for DQ0 occurred	0	RidPrefixCompare0Event	49232	Event name	
Hardware interrupt	0	Compare event DQ00	Compare event DQ00	Channel number	0
HwEventTypeCompare0	5				
High speed counters (HSC)\HSC 3\Channel 0\Hardware interrupts\Hardware interrupt by counter value/position value\					
Comparison event for DQ1 occurred	0	RidPrefixCompare1Event	49248	Event name	
Hardware interrupt	0	Compare event DQ10	Compare event DQ10	Channel number	0
HwEventTypeCompare1	6				
High speed counters (HSC)\HSC 3\Channel 0\Counter inputs\Specify input signals/encoder type					
Signal type	Pulse (A) and direction (B)	Invert direction	False		
High speed counters (HSC)\HSC 3\Channel 0\Counter inputs\Additional parameters					
Signal evaluation	Single	Filter frequency	100 kHz	Reaction to signal N	No reaction to signal N
High speed counters (HSC)\HSC 3\Channel 0\Counter behavior\Counting limits and start value					
High counting limit	2147483647	Start value	0	Low counting limit	-2147483648
High speed counters (HSC)\HSC 3\Channel 0\Counter behavior\Counter behavior at limits and gate start					
Reaction to violation of a counting limit	Continue counting	Reset when counting limit is violated	To opposite counting limit	Reaction to gate start	Continue with current value
High speed counters (HSC)\HSC 3\Channel 0\Behavior of inputs\Behavior of DI0\Function of DI0					
Set function of DI	Digital input without function	HSC DI0	None	Input delay	No input for DI0 selected
High speed counters (HSC)\HSC 3\Channel 0\Behavior of inputs\Behavior of DI1\Function of DI1					
Set function of DI	Digital input without function	HSC DI1	None	Input delay	No input for DI1 selected

Instrumentation Tools

Totally Integrated Automation Portal					
High speed counters (HSC)\HSC 3\Channel 0\Behavior of outputs\Behavior of DQ0\Function of DQ0					
Set output	Between comparison value 0 and high limit	Comparison value 0	0	Comparison value 1	10
Count direction	In both directions	Pulse duration	500.0ms	Substitute value for DQ0	0
HSC DQ0	Only available via feedback interface				
High speed counters (HSC)\HSC 3\Channel 0\Behavior of outputs\Behavior of DQ1\Function of DQ1					
Set output	Between comparison value 1 and high limit	Comparison value 0	0	Comparison value 1	10
Count direction	In both directions	Pulse duration	500.0ms	Substitute value for DQ1	0
HSC DQ1	None				
High speed counters (HSC)\HSC 3\Channel 0\Hysteresis\Set hysteresis range					
Hysteresis (in increments)	0				
High speed counters (HSC)\HSC 3\Channel 0\Measured value\Specify measured value					
Measured variable	Frequency	Update time	10.000ms		
High speed counters (HSC)\HSC 3\Hardware inputs/outputs					
Pulse input (A)	X11, Clamp 7 (DI6 / %I10.6)	Direction input (B)	X11, Clamp 8 (DI7 / %I10.7)	Reset input (N)	None
HSC DI0	None	HSC DI1	None	HSC DQ0	Only available via feedback interface
HSC DQ1	None				
High speed counters (HSC)\HSC 3\I/O addresses\Input addresses					
Start address	46.0	End address	61.7	Organization block	0
Process image	0				
High speed counters (HSC)\HSC 3\I/O addresses\Output addresses					
Start address	32.0	End address	43.7	Organization block	0
Process image	0				
High speed counters (HSC)\HSC 4\General\Enable					
Activate this high-speed counter	False				
High speed counters (HSC)\HSC 4\General\Project information					
Name	HSC_4	Author	Mmuhamed	Comment	
High speed counters (HSC)\HSC 4\Channel 0\Operating mode					
Selection of operating mode	Operating with technology object "Counting and measurement"				
High speed counters (HSC)\HSC 4\Channel 0\Reaction to CPU STOP					
Reaction to CPU STOP	Output substitute value	Substitute value for DQ0	0	Substitute value for DQ1	0
High speed counters (HSC)\HSC 4\Channel 0\Diagnostic interrupts					
Enable diagnostic interrupts	False				
High speed counters (HSC)\HSC 4\Channel 0\Hardware interrupts\Hardware interrupt triggered by external events\					
New capture value available	0	RidPrefixCaptureEvent	49280	Event name	
Hardware interrupt	0	Capture value0	Capture value0	Channel number	0
HwEventTypeCapture	8				
High speed counters (HSC)\HSC 4\Channel 0\Hardware interrupts\Hardware interrupt triggered by external events\					
Synchronization of the counter by an external signal	0	RidPrefixSyncEvent	49296	Event name	
Hardware interrupt	0	Synchronization0	Synchronization0	Channel number	0
HwEventTypeSync	9				
High speed counters (HSC)\HSC 4\Channel 0\Hardware interrupts\Hardware interrupt triggered by external events\					
Gate start	0	RidPrefixGateStartEvent	49168	Event name	
Hardware interrupt	0	Gate start0	Gate start0	Channel number	0
HwEventTypeGateStart	1				
High speed counters (HSC)\HSC 4\Channel 0\Hardware interrupts\Hardware interrupt triggered by external events\					
Gate stop	0	RidPrefixGateStopEvent	49184	Event name	
Hardware interrupt	0	Gate stop0	Gate stop0	Channel number	0
HwEventTypeGateStop	2				
High speed counters (HSC)\HSC 4\Channel 0\Hardware interrupts\Hardware interrupt by counter value/position value\					
Overflow (high counting limit violated)	0	RidPrefixOverflowEvent	49200	Event name	
Hardware interrupt	0	Overflow0	Overflow0	Channel number	0
HwEventTypeOverflow	3				
High speed counters (HSC)\HSC 4\Channel 0\Hardware interrupts\Hardware interrupt by counter value/position value\					
Underflow (low counting limit violated)	0	RidPrefixUnderflowEvent	49216	Event name	
Hardware interrupt	0	Underflow0	Underflow0	Channel number	0
HwEventTypeUnderflow	4				
High speed counters (HSC)\HSC 4\Channel 0\Hardware interrupts\Hardware interrupt by counter value/position value\					
Direction reversal	0	RidPrefixDirectionChangedEvent	49312	Event name	
Hardware interrupt	0	Direction reversal0	Direction reversal0	Channel number	0
HwEventTypeDirectionChanged	10				
High speed counters (HSC)\HSC 4\Channel 0\Hardware interrupts\Hardware interrupt by counter value/position value\					
Zero crossing	0	RidPrefixZeroCrossingEvent	49264	Event name	
Hardware interrupt	0	Zero crossing0	Zero crossing0	Channel number	0
HwEventTypeZeroCrossing	7				

Instrumentation Tools

Totally Integrated Automation Portal						
High speed counters (HSC)\HSC 4\Channel 0\Hardware interrupts\Hardware interrupt by counter value/position value\						
Comparison event for DQ0 occurred	0	RidPrefixCompare0Event	49232	Event name		
Hardware interrupt	0	Compare event DQ00	Compare event DQ00	Channel number	0	
HwEventTypeCompare0	5					
High speed counters (HSC)\HSC 4\Channel 0\Hardware interrupts\Hardware interrupt by counter value/position value\						
Comparison event for DQ1 occurred	0	RidPrefixCompare1Event	49248	Event name		
Hardware interrupt	0	Compare event DQ10	Compare event DQ10	Channel number	0	
HwEventTypeCompare1	6					
High speed counters (HSC)\HSC 4\Channel 0\Counter inputs\Specify input signals/encoder type						
Signal type	Pulse (A) and direction (B)		Invert direction	False		
High speed counters (HSC)\HSC 4\Channel 0\Counter inputs\Additional parameters						
Signal evaluation	Single	Filter frequency	100 kHz	Reaction to signal N	No reaction to signal N	
High speed counters (HSC)\HSC 4\Channel 0\Counter behavior\Counting limits and start value						
High counting limit	2147483647	Start value	0	Low counting limit	-2147483648	
High speed counters (HSC)\HSC 4\Channel 0\Counter behavior\Counter behavior at limits and gate start						
Reaction to violation of a counting limit	Continue counting	Reset when counting limit is violated	To opposite counting limit	Reaction to gate start	Continue with current value	
High speed counters (HSC)\HSC 4\Channel 0\Behavior of inputs\Behavior of DI0\Function of DI0						
Set function of DI	Digital input without function	HSC DI0	None	Input delay	No input for DI0 selected	
High speed counters (HSC)\HSC 4\Channel 0\Behavior of inputs\Behavior of DI1\Function of DI1						
Set function of DI	Digital input without function	HSC DI1	None	Input delay	No input for DI1 selected	
High speed counters (HSC)\HSC 4\Channel 0\Behavior of outputs\Behavior of DQ0\Function of DQ0						
Set output	Between comparison value 0 and high limit	Comparison value 0	0	Comparison value 1	10	
Count direction	In both directions	Pulse duration	500.0ms	Substitute value for DQ0	0	
HSC DQ0	Only available via feedback interface					
High speed counters (HSC)\HSC 4\Channel 0\Behavior of outputs\Behavior of DQ1\Function of DQ1						
Set output	Between comparison value 1 and high limit	Comparison value 0	0	Comparison value 1	10	
Count direction	In both directions	Pulse duration	500.0ms	Substitute value for DQ1	0	
HSC DQ1	None					
High speed counters (HSC)\HSC 4\Channel 0\Hysteresis\Set hysteresis range						
Hysteresis (in increments)	0					
High speed counters (HSC)\HSC 4\Channel 0\Measured value\Specify measured value						
Measured variable	Frequency	Update time	10.000ms			
High speed counters (HSC)\HSC 4\Hardware inputs/outputs						
Pulse input (A)	X12, Clamp 1 (DI0 / %I12.0)	Direction input (B)	X12, Clamp 2 (DI1 / %I12.1)	Reset input (N)	None	
HSC DI0	None	HSC DI1	None	HSC DQ0	Only available via feedback interface	
HSC DQ1	None					
High speed counters (HSC)\HSC 4\I/O addresses\Input addresses						
Start address	62.0	End address	77.7	Organization block	0	
Process image	0					
High speed counters (HSC)\HSC 4\I/O addresses\Output addresses						
Start address	44.0	End address	55.7	Organization block	0	
Process image	0					
High speed counters (HSC)\HSC 5\General\Enable						
Activate this high-speed counter	False					
High speed counters (HSC)\HSC 5\General\Project information						
Name	HSC_5	Author	Mmuhammed	Comment		
High speed counters (HSC)\HSC 5\Channel 0\Operating mode						
Selection of operating mode	Operating with technology object "Counting and measurement"					
High speed counters (HSC)\HSC 5\Channel 0\Reaction to CPU STOP						
Reaction to CPU STOP	Output substitute value	Substitute value for DQ0	0	Substitute value for DQ1	0	
High speed counters (HSC)\HSC 5\Channel 0\Diagnostic interrupts						
Enable diagnostic interrupts	False					
High speed counters (HSC)\HSC 5\Channel 0\Hardware interrupts\Hardware interrupt triggered by external events\						
New capture value available	0	RidPrefixCaptureEvent	49280	Event name		
Hardware interrupt	0	Capture value0	Capture value0	Channel number	0	
HwEventTypeCapture	8					
High speed counters (HSC)\HSC 5\Channel 0\Hardware interrupts\Hardware interrupt triggered by external events\						
Synchronization of the counter by an external signal	0	RidPrefixSyncEvent	49296	Event name		
Hardware interrupt	0	Synchronization0	Synchronization0	Channel number	0	
HwEventTypeSync	9					
High speed counters (HSC)\HSC 5\Channel 0\Hardware interrupts\Hardware interrupt triggered by external events\						
Gate start	0	RidPrefixGateStartEvent	49168	Event name		
Hardware interrupt	0	Gate start0	Gate start0	Channel number	0	
HwEventTypeGateStart	1					
High speed counters (HSC)\HSC 5\Channel 0\Hardware interrupts\Hardware interrupt triggered by external events\						
Gate stop	0	RidPrefixGateStopEvent	49184	Event name		
Hardware interrupt	0	Gate stop0	Gate stop0	Channel number	0	
HwEventTypeGateStop	2					

Instrumentation Tools

Totally Integrated Automation Portal					
High speed counters (HSC)\HSC 5\Channel 0\Hardware interrupts\Hardware interrupt by counter value/position value\					
Overflow (high counting limit violated)	0	RidPrefixOverflowEvent	49200	Event name	
Hardware interrupt	0	Overflow0	Overflow0	Channel number	0
HwEventTypeOverflow	3				
High speed counters (HSC)\HSC 5\Channel 0\Hardware interrupts\Hardware interrupt by counter value/position value\					
Underflow (low counting limit violated)	0	RidPrefixUnderflowEvent	49216	Event name	
Hardware interrupt	0	Underflow0	Underflow0	Channel number	0
HwEventTypeUnderflow	4				
High speed counters (HSC)\HSC 5\Channel 0\Hardware interrupts\Hardware interrupt by counter value/position value\					
Direction reversal	0	RidPrefixDirection-ChangedEvent	49312	Event name	
Hardware interrupt	0	Direction reversal0	Direction reversal0	Channel number	0
HwEventTypeDirectionChanged	10				
High speed counters (HSC)\HSC 5\Channel 0\Hardware interrupts\Hardware interrupt by counter value/position value\					
Zero crossing	0	RidPrefixZeroCrossingEvent	49264	Event name	
Hardware interrupt	0	Zero crossing0	Zero crossing0	Channel number	0
HwEventTypeZeroCrossing	7				
High speed counters (HSC)\HSC 5\Channel 0\Hardware interrupts\Hardware interrupt by counter value/position value\					
Comparison event for DQ0 occurred	0	RidPrefixCompare0Event	49232	Event name	
Hardware interrupt	0	Compare event DQ00	Compare event DQ00	Channel number	0
HwEventTypeCompare0	5				
High speed counters (HSC)\HSC 5\Channel 0\Hardware interrupts\Hardware interrupt by counter value/position value\					
Comparison event for DQ1 occurred	0	RidPrefixCompare1Event	49248	Event name	
Hardware interrupt	0	Compare event DQ10	Compare event DQ10	Channel number	0
HwEventTypeCompare1	6				
High speed counters (HSC)\HSC 5\Channel 0\Counter inputs\Specify input signals/encoder type					
Signal type	Pulse (A) and direction (B)		Invert direction	False	
High speed counters (HSC)\HSC 5\Channel 0\Counter inputs\Additional parameters					
Signal evaluation	Single	Filter frequency	100 kHz	Reaction to signal N	No reaction to signal N
High speed counters (HSC)\HSC 5\Channel 0\Counter behavior\Counting limits and start value					
High counting limit	2147483647	Start value	0	Low counting limit	-2147483648
High speed counters (HSC)\HSC 5\Channel 0\Counter behavior\Counter behavior at limits and gate start					
Reaction to violation of a counting limit	Continue counting	Reset when counting limit is violated	To opposite counting limit	Reaction to gate start	Continue with current value
High speed counters (HSC)\HSC 5\Channel 0\Behavior of inputs\Behavior of DI0\Function of DI0					
Set function of DI	Digital input without function	HSC DI0	None	Input delay	No input for DI0 selected
High speed counters (HSC)\HSC 5\Channel 0\Behavior of inputs\Behavior of DI1\Function of DI1					
Set function of DI	Digital input without function	HSC DI1	None	Input delay	No input for DI1 selected
High speed counters (HSC)\HSC 5\Channel 0\Behavior of outputs\Behavior of DQ0\Function of DQ0					
Set output	Between comparison value 0 and high limit	Comparison value 0	0	Comparison value 1	10
Count direction	In both directions	Pulse duration	500.0ms	Substitute value for DQ0	0
HSC DQ0	Only available via feedback interface				
High speed counters (HSC)\HSC 5\Channel 0\Behavior of outputs\Behavior of DQ1\Function of DQ1					
Set output	Between comparison value 1 and high limit	Comparison value 0	0	Comparison value 1	10
Count direction	In both directions	Pulse duration	500.0ms	Substitute value for DQ1	0
HSC DQ1	None				
High speed counters (HSC)\HSC 5\Channel 0\Hysteresis\Set hysteresis range					
Hysteresis (in increments)	0				
High speed counters (HSC)\HSC 5\Channel 0\Measured value\Specify measured value					
Measured variable	Frequency	Update time	10.000ms		
High speed counters (HSC)\HSC 5\Hardware inputs/outputs					
Pulse input (A)	X12, Clamp 4 (DI3 / %I12.3)	Direction input (B)	X12, Clamp 5 (DI4 / %I12.4)	Reset input (N)	None
HSC DI0	None	HSC DI1	None	HSC DQ0	Only available via feedback interface
HSC DQ1	None				
High speed counters (HSC)\HSC 5\I/O addresses\Input addresses					
Start address	78.0	End address	93.7	Organization block	0
Process image	0				
High speed counters (HSC)\HSC 5\I/O addresses\Output addresses					
Start address	56.0	End address	67.7	Organization block	0
Process image	0				
High speed counters (HSC)\HSC 6\General\Enable					
Activate this high-speed counter	False				
High speed counters (HSC)\HSC 6\General\Project information					
Name	HSC_6	Author	Mmuhammed	Comment	
High speed counters (HSC)\HSC 6\Channel 0\Operating mode					
Selection of operating mode	Operating with technology object "Counting and measurement"				
High speed counters (HSC)\HSC 6\Channel 0\Reaction to CPU STOP					
Reaction to CPU STOP	Output substitute value	Substitute value for DQ0	0	Substitute value for DQ1	0

Instrumentation Tools

Totally Integrated Automation Portal					
High speed counters (HSC)\HSC 6\Channel 0\Diagnostic interrupts					
Enable diagnostic interrupts	False				
High speed counters (HSC)\HSC 6\Channel 0\Hardware interrupts\Hardware interrupt triggered by external events\					
New capture value available	0	RidPrefixCaptureEvent	49280	Event name	
Hardware interrupt	0	Capture value0	Capture value0	Channel number	0
HwEventTypeCapture	8				
High speed counters (HSC)\HSC 6\Channel 0\Hardware interrupts\Hardware interrupt triggered by external events\					
Synchronization of the counter by an external signal	0	RidPrefixSyncEvent	49296	Event name	
Hardware interrupt	0	Synchronization0	Synchronization0	Channel number	0
HwEventTypeSync	9				
High speed counters (HSC)\HSC 6\Channel 0\Hardware interrupts\Hardware interrupt triggered by external events\					
Gate start	0	RidPrefixGateStartEvent	49168	Event name	
Hardware interrupt	0	Gate start0	Gate start0	Channel number	0
HwEventTypeGateStart	1				
High speed counters (HSC)\HSC 6\Channel 0\Hardware interrupts\Hardware interrupt triggered by external events\					
Gate stop	0	RidPrefixGateStopEvent	49184	Event name	
Hardware interrupt	0	Gate stop0	Gate stop0	Channel number	0
HwEventTypeGateStop	2				
High speed counters (HSC)\HSC 6\Channel 0\Hardware interrupts\Hardware interrupt by counter value/position value\					
Overflow (high counting limit violated)	0	RidPrefixOverflowEvent	49200	Event name	
Hardware interrupt	0	Overflow0	Overflow0	Channel number	0
HwEventTypeOverflow	3				
High speed counters (HSC)\HSC 6\Channel 0\Hardware interrupts\Hardware interrupt by counter value/position value\					
Underflow (low counting limit violated)	0	RidPrefixUnderflowEvent	49216	Event name	
Hardware interrupt	0	Underflow0	Underflow0	Channel number	0
HwEventTypeUnderflow	4				
High speed counters (HSC)\HSC 6\Channel 0\Hardware interrupts\Hardware interrupt by counter value/position value\					
Direction reversal	0	RidPrefixDirectionChangedEvent	49312	Event name	
Hardware interrupt	0	Direction reversal0	Direction reversal0	Channel number	0
HwEventTypeDirectionChanged	10				
High speed counters (HSC)\HSC 6\Channel 0\Hardware interrupts\Hardware interrupt by counter value/position value\					
Zero crossing	0	RidPrefixZeroCrossingEvent	49264	Event name	
Hardware interrupt	0	Zero crossing0	Zero crossing0	Channel number	0
HwEventTypeZeroCrossing	7				
High speed counters (HSC)\HSC 6\Channel 0\Hardware interrupts\Hardware interrupt by counter value/position value\					
Comparison event for DQ0 occurred	0	RidPrefixCompare0Event	49232	Event name	
Hardware interrupt	0	Compare event DQ00	Compare event DQ00	Channel number	0
HwEventTypeCompare0	5				
High speed counters (HSC)\HSC 6\Channel 0\Hardware interrupts\Hardware interrupt by counter value/position value\					
Comparison event for DQ1 occurred	0	RidPrefixCompare1Event	49248	Event name	
Hardware interrupt	0	Compare event DQ10	Compare event DQ10	Channel number	0
HwEventTypeCompare1	6				
High speed counters (HSC)\HSC 6\Channel 0\Counter inputs\Specify input signals/encoder type					
Signal type	Pulse (A) and direction (B)	Invert direction	False		
High speed counters (HSC)\HSC 6\Channel 0\Counter inputs\Additional parameters					
Signal evaluation	Single	Filter frequency	100 kHz	Reaction to signal N	No reaction to signal N
High speed counters (HSC)\HSC 6\Channel 0\Counter behavior\Counting limits and start value					
High counting limit	2147483647	Start value	0	Low counting limit	-2147483648
High speed counters (HSC)\HSC 6\Channel 0\Counter behavior\Counter behavior at limits and gate start					
Reaction to violation of a counting limit	Continue counting	Reset when counting limit is violated	To opposite counting limit	Reaction to gate start	Continue with current value
High speed counters (HSC)\HSC 6\Channel 0\Behavior of inputs\Behavior of DI0\Function of DI0					
Set function of DI	Digital input without function	HSC DI0	None	Input delay	No input for DI0 selected
High speed counters (HSC)\HSC 6\Channel 0\Behavior of inputs\Behavior of DI1\Function of DI1					
Set function of DI	Digital input without function	HSC DI1	None	Input delay	No input for DI1 selected
High speed counters (HSC)\HSC 6\Channel 0\Behavior of outputs\Behavior of DQ0\Function of DQ0					
Set output	Between comparison value 0 and high limit	Comparison value 0	0	Comparison value 1	10
Count direction	In both directions	Pulse duration	500.0ms	Substitute value for DQ0	0
HSC DQ0	Only available via feedback interface				
High speed counters (HSC)\HSC 6\Channel 0\Behavior of outputs\Behavior of DQ1\Function of DQ1					
Set output	Between comparison value 1 and high limit	Comparison value 0	0	Comparison value 1	10
Count direction	In both directions	Pulse duration	500.0ms	Substitute value for DQ1	0
HSC DQ1	None				

Instrumentation Tools

Totally Integrated Automation Portal					
High speed counters (HSC)\HSC 6\Channel 0\Hysteresis\Set hysteresis range					
Hysteresis (in increments)	0				
High speed counters (HSC)\HSC 6\Channel 0\Measured value\Specify measured value					
Measured variable	Frequency	Update time	10.000ms		
High speed counters (HSC)\HSC 6\Hardware inputs/outputs					
Pulse input (A)	X12, Clamp 7 (DI6 / %I12.6)	Direction input (B)	X12, Clamp 8 (DI7 / %I12.7)	Reset input (N)	None
HSC DI0	None	HSC DI1	None	HSC DQ0	Only available via feedback interface
HSC DQ1	None				
High speed counters (HSC)\HSC 6\I/O addresses\Input addresses					
Start address	94.0	End address	109.7	Organization block	0
Process image	0				
High speed counters (HSC)\HSC 6\I/O addresses\Output addresses					
Start address	68.0	End address	79.7	Organization block	0
Process image	0				
Pulse generators (PTO/PWM)\CPU 1511C compatibility					
Front connector assignment like CPU 1511C	False				
Pulse generators (PTO/PWM)\PTO1/PWM1\General\Project information					
Name	Pulse_1	Comment			
Pulse generators (PTO/PWM)\PTO1/PWM1\General\Operating mode					
Operating mode	Deactivated				
Pulse generators (PTO/PWM)\PTO1/PWM1\Reaction to CPU STOP					
Reaction to CPU STOP	Output substitute value	Substitute value for pulse output (DQA)	0		
Pulse generators (PTO/PWM)\PTO1/PWM1\Diagnostic interrupts					
No supply voltage L+	False				
Pulse generators (PTO/PWM)\PTO1/PWM1\Hardware inputs/outputs					
Pulse output (DQA)	X11, Clamp 21 (DQ0 / %Q4.0): 10 kHz / 0.5 A or 100 kHz / 0.1 A	High-speed output (0.1 A)	False		
Pulse generators (PTO/PWM)\PTO1/PWM1\Parameters					
Output format	Per 100				
Pulse generators (PTO/PWM)\PTO1/PWM1\I/O addresses\Input addresses					
Start address	110.0	End address	113.7	Organization block	0
Process image	0				
Pulse generators (PTO/PWM)\PTO1/PWM1\I/O addresses\Output addresses					
Start address	80.0	End address	91.7	Organization block	0
Process image	0				
Pulse generators (PTO/PWM)\PTO2/PWM2\General\Project information					
Name	Pulse_2	Comment			
Pulse generators (PTO/PWM)\PTO2/PWM2\General\Operating mode					
Operating mode	Deactivated				
Pulse generators (PTO/PWM)\PTO2/PWM2\Reaction to CPU STOP					
Reaction to CPU STOP	Output substitute value	Substitute value for pulse output (DQA)	0		
Pulse generators (PTO/PWM)\PTO2/PWM2\Diagnostic interrupts					
No supply voltage L+	False				
Pulse generators (PTO/PWM)\PTO2/PWM2\Hardware inputs/outputs					
Pulse output (DQA)	X11, Clamp 23 (DQ2 / %Q4.2): 10 kHz / 0.5 A or 100 kHz / 0.1 A	High-speed output (0.1 A)	False		
Pulse generators (PTO/PWM)\PTO2/PWM2\Parameters					
Output format	Per 100				
Pulse generators (PTO/PWM)\PTO2/PWM2\I/O addresses\Input addresses					
Start address	114.0	End address	117.7	Organization block	0
Process image	0				
Pulse generators (PTO/PWM)\PTO2/PWM2\I/O addresses\Output addresses					
Start address	92.0	End address	103.7	Organization block	0
Process image	0				
Pulse generators (PTO/PWM)\PTO3/PWM3\General\Project information					
Name	Pulse_3	Comment			
Pulse generators (PTO/PWM)\PTO3/PWM3\General\Operating mode					
Operating mode	Deactivated				
Pulse generators (PTO/PWM)\PTO3/PWM3\Reaction to CPU STOP					
Reaction to CPU STOP	Output substitute value	Substitute value for pulse output (DQA)	0		
Pulse generators (PTO/PWM)\PTO3/PWM3\Diagnostic interrupts					
No supply voltage L+	False				
Pulse generators (PTO/PWM)\PTO3/PWM3\Hardware inputs/outputs					
Pulse output (DQA)	X11, Clamp 25 (DQ4 / %Q4.4): 10 kHz / 0.5 A or 100 kHz / 0.1 A	High-speed output (0.1 A)	False		
Pulse generators (PTO/PWM)\PTO3/PWM3\Parameters					
Output format	Per 100				
Pulse generators (PTO/PWM)\PTO3/PWM3\I/O addresses\Input addresses					
Start address	118.0	End address	121.7	Organization block	0
Process image	0				
Pulse generators (PTO/PWM)\PTO3/PWM3\I/O addresses\Output addresses					
Start address	104.0	End address	115.7	Organization block	0
Process image	0				
Pulse generators (PTO/PWM)\PTO4/PWM4\General\Project information					
Name	Pulse_4	Comment			
Pulse generators (PTO/PWM)\PTO4/PWM4\General\Operating mode					
Operating mode	Deactivated				
Pulse generators (PTO/PWM)\PTO4/PWM4\Reaction to CPU STOP					
Reaction to CPU STOP	Output substitute value	Substitute value for pulse output (DQA)	0		

Instrumentation Tools

Totally Integrated Automation Portal						
Pulse generators (PTO/PWM)\PTO4/PWM4\Diagnostic interrupts						
No supply voltage L+	False					
Pulse generators (PTO/PWM)\PTO4/PWM4\Hardware inputs/outputs						
Pulse output (DQA)	X11, Clamp 27 (DQ6 / %Q4.6): 10 kHz / 0.5 A or 100 kHz / 0.1 A	High-speed output (0.1 A)	False			
Pulse generators (PTO/PWM)\PTO4/PWM4\Parameters						
Output format	Per 100					
Pulse generators (PTO/PWM)\PTO4/PWM4\I/O addresses\Input addresses						
Start address	122.0	End address	125.7	Organization block	0	
Process image	0					
Pulse generators (PTO/PWM)\PTO4/PWM4\I/O addresses\Output addresses						
Start address	116.0	End address	127.7	Organization block	0	
Process image	0					
Startup						
Startup after POWER ON	Warm restart - Operating mode before POWER OFF	Comparison preset to actual configuration	Startup CPU even if mismatch	Configuration time	60000ms	
Cycle						
Maximum cycle time	150ms			Enable minimum cycle time for cyclic OBs	True	
Minimum cycle time	1ms					
Communication load						
Cycle load due to communication	50%					
System and clock memory\System memory bits						
Enable the use of system memory byte	False	Address of system memory byte (MBx)	1	First cycle		
Diagnostic status changed		Always 1 (high)		Always 0 (low)		
System and clock memory\Clock memory bits						
Enable the use of clock memory byte	False	Address of clock memory byte (MBx)	0	10 Hz clock		
5 Hz clock		2.5 Hz clock		2 Hz clock		
1.25 Hz clock		1 Hz clock		0.625 Hz clock		
0.5 Hz clock						
SIMATIC Memory Card\Diagnostics						
Aging of the SIMATIC memory card	False	Threshold value	80%			
System diagnostics\General						
Activate system diagnostics for this device	True	Report network faults as maintenance instead of fault	False			
PLC alarms\General						
Central alarm management in the PLC	True					
Web server\General						
Activate web server on this module	False	Permit access only with HTTPS	True			
Web server\Automatic update						
Enable automatic update	True	Update interval	0s			
Web server\User management						
User name			User rights			
Everybody						
Web server\User-defined web pages						
Application name	HTML source path	Default HTML page	Files with dynamic content	Web DB number	Fragment DB number	
		index.htm	.htm;.html	333	334	
Web server\Overview of interfaces						
Device	Interface			Enabled web server access		
PLC_1	PROFINET interface_1			False		
DNS configuration						
No DNS server address is configured.						
Display\General\Display standby mode						
Time to standby mode	30 minutes					
Display\General\Energy saving mode						
Time to energy saving mode	15 minutes					
Display\General\Display language						
Default language on display	English					
Display\Automatic update						
Time to update	5 seconds					
Display>Password\Display protection						
Enable write access	True	Enable display protection	False			
Display\User-defined logo						
User logo activated	False	Adapt logo	False	Resolution	128x120	
Company logo	---					

Instrumentation Tools

Totally Integrated Automation Portal				
User interface languages				
Assign project language		User interface languages		
English (United States)		German		
English (United States)		English		
English (United States)		French		
English (United States)		Spanish		
English (United States)		Italian		
English (United States)		Japanese		
English (United States)		Chinese (simplified)		
English (United States)		Korean		
English (United States)		Russian		
English (United States)		Turkish		
English (United States)		Portuguese (Brazil)		
Time of day\Local time				
Time zone	(UTC) Dublin, Edinburgh, Lisbon, London			
Time of day\Daylight saving time				
Activate daylight saving time	True	Difference between standard and daylight saving time	60 mins	
Time of day\Daylight saving time\Start of daylight saving time				
Selection of the week	Last	Selection of the weekday	Sunday	of March
at	01:00 a.m.			
Time of day\Daylight saving time\Start of standard time				
Selection of the week	Last	Selection of the weekday	Sunday	of October
at	02:00 a.m.			
Protection				
Level of protection	Full access (no protection)			
Protection\Connection mechanisms				
Permit access with PUT/GET communication from remote partner	False			
Protection\Security event				
Summarize security events in case of high message volume	True	Length of an interval	20	Unit seconds
OPC UA\Accessibility of the server				
Activate OPC UA server	False			
System power supply\General				
General	Connection to supply voltage L+			
System power supply\Power segment overview				
Module	Slot	Supply/consumption		
PLC_1	1	10.00W		
	Summary	10.00W		
Configuration control\Configuration control for central configuration				
Allow reconfiguration of device via the user program	False			
Connection resources\				
	Station resources - Reserved - Maximum	Station resources - Reserved - Configured	Station resources - Dynamic - Configured	Module resources - PLC_1 [CPU 1512C-1 PN] - Configured
Maximum number of resources:		10	78	88
	Maximum	Configured	Configured	Configured
PG communication:	4	-	-	-
HMI communication:	4	2	0	2
S7 communication:	0	-	0	0
Open user communication:	0	-	0	0
Web communication:	2	-	-	-
OPC UA client/server communication:	0	-	-	-
Other communication:	-	-	0	0
Total resources used:		2	0	2
Available resources:		8	78	86
Overview of addresses\Overview of addresses\Overview of addresses				
Inputs	True	Outputs	True	Address gaps False
Slot	True			

Instrumentation Tools

Totally Integrated Automation Portal											
Type	Addr. from	Addr. to	Module	PIP	OB	Device name	Device number	Size	Master / IO system	Rack	Slot
I	0	9	AI 5/AQ 2_1	Automatic update	-	PLC_1 [CPU 1512C-1 PN]	-	10 Bytes	-	0	1 8
O	0	3	AI 5/AQ 2_1	Automatic update	-	PLC_1 [CPU 1512C-1 PN]	-	4 Bytes	-	0	1 8
I	10	11	DI 16/DQ 16_1	Automatic update	-	PLC_1 [CPU 1512C-1 PN]	-	2 Bytes	-	0	1 9
O	4	5	DI 16/DQ 16_1	Automatic update	-	PLC_1 [CPU 1512C-1 PN]	-	2 Bytes	-	0	1 9
I	12	13	DI 16/DQ 16_2	Automatic update	-	PLC_1 [CPU 1512C-1 PN]	-	2 Bytes	-	0	1 10
O	6	7	DI 16/DQ 16_2	Automatic update	-	PLC_1 [CPU 1512C-1 PN]	-	2 Bytes	-	0	1 10
I	14	29	HSC_1	Automatic update	-	PLC_1 [CPU 1512C-1 PN]	-	16 Bytes	-	0	1 16
O	8	19	HSC_1	Automatic update	-	PLC_1 [CPU 1512C-1 PN]	-	12 Bytes	-	0	1 16
I	30	45	HSC_2	Automatic update	-	PLC_1 [CPU 1512C-1 PN]	-	16 Bytes	-	0	1 17
O	20	31	HSC_2	Automatic update	-	PLC_1 [CPU 1512C-1 PN]	-	12 Bytes	-	0	1 17
I	46	61	HSC_3	Automatic update	-	PLC_1 [CPU 1512C-1 PN]	-	16 Bytes	-	0	1 18
O	32	43	HSC_3	Automatic update	-	PLC_1 [CPU 1512C-1 PN]	-	12 Bytes	-	0	1 18
I	62	77	HSC_4	Automatic update	-	PLC_1 [CPU 1512C-1 PN]	-	16 Bytes	-	0	1 19
O	44	55	HSC_4	Automatic update	-	PLC_1 [CPU 1512C-1 PN]	-	12 Bytes	-	0	1 19
I	78	93	HSC_5	Automatic update	-	PLC_1 [CPU 1512C-1 PN]	-	16 Bytes	-	0	1 20
O	56	67	HSC_5	Automatic update	-	PLC_1 [CPU 1512C-1 PN]	-	12 Bytes	-	0	1 20
I	94	109	HSC_6	Automatic update	-	PLC_1 [CPU 1512C-1 PN]	-	16 Bytes	-	0	1 21
O	68	79	HSC_6	Automatic update	-	PLC_1 [CPU 1512C-1 PN]	-	12 Bytes	-	0	1 21
I	110	113	Pulse_1	Automatic update	-	PLC_1 [CPU 1512C-1 PN]	-	4 Bytes	-	0	1 32
O	80	91	Pulse_1	Automatic update	-	PLC_1 [CPU 1512C-1 PN]	-	12 Bytes	-	0	1 32
I	114	117	Pulse_2	Automatic update	-	PLC_1 [CPU 1512C-1 PN]	-	4 Bytes	-	0	1 33
O	92	103	Pulse_2	Automatic update	-	PLC_1 [CPU 1512C-1 PN]	-	12 Bytes	-	0	1 33
I	118	121	Pulse_3	Automatic update	-	PLC_1 [CPU 1512C-1 PN]	-	4 Bytes	-	0	1 34
O	104	115	Pulse_3	Automatic update	-	PLC_1 [CPU 1512C-1 PN]	-	12 Bytes	-	0	1 34
I	122	125	Pulse_4	Automatic update	-	PLC_1 [CPU 1512C-1 PN]	-	4 Bytes	-	0	1 35
O	116	127	Pulse_4	Automatic update	-	PLC_1 [CPU 1512C-1 PN]	-	12 Bytes	-	0	1 35
Runtime licenses\OPC UA\Runtime licenses											
Type of required license	None		Type of purchased license	No license							
Runtime licenses\ProDiag\Supervisions											
Number of used supervisions	0										
Runtime licenses\ProDiag\Runtime licenses											
Number of required licenses	None (<= 25 supervisions)		Used ProDiag licenses	No license							
Runtime licenses\Energy Suite\Energy objects											
Number of configured energy objects	0										
Runtime licenses\Energy Suite\Runtime licenses											
Total number of licensed energy objects	0										
Runtime licenses\Energy Suite\Runtime licenses\Number of purchased licenses											
License type '5 energy objects'	No license		License type '10 energy objects'	No license							

PID_PWM and PID_Output

PC station [SIMATIC PC station]

PC station

General

Name	PC station	Computer name identical to PC station name	No	Computer name	
------	------------	--	----	---------------	--

Author	Mmuhamed	Comment			
--------	----------	---------	--	--	--

XDB configuration

S7RTM is installed (for example the SIMATIC NET PC software)	No	Generate XDB file	No	XDB file storage path	
--	----	-------------------	----	-----------------------	--

Totally Integrated Automation Portal		
--------------------------------------	--	--

PID_PWM and PID_Output / PC station [SIMATIC PC station]

HMI_RT_1 [WinCC RT Advanced]

HMI_RT_1					
General					
Name	HMI_RT_1	Device/application type	SIMATIC PC station - WinCC RT Advanced	Author	Mmuhamed
Comment					
General\Catalog information					
Short designation	WinCC RT Advanced	Description	Runtime software for PC-based visualization (requires WinCC Runtime Advanced)	Article number	6AV2 104-0xxxx-xxxx
Version	16.0.0.0				
Information					
Number of used PowerTags	23	Memory requirements in runtime	112036	Compilation build number	34
Date of last compilation	8/19/2023 3:53 PM	Date of last download			

Instrumentation Tools

Totally Integrated Automation Portal		
--------------------------------------	--	--

PID_PWM and PID_Output / PC station [SIMATIC PC station] / HMI_RT_1 [WinCC RT Advanced]

Runtime settings

General

Start screen	Control	Load name information	Enabled	Default template	
Default style of the project	Disabled	Style of the HMI device	WinCC Fresh V 1.0.1	Adapt font size to style	Enabled
Screen resolution	1280, 800	Full-screen mode	Disabled	Lock task switching	Disabled
Project ID	0	Logging language	Startup language		

Services

Sm@rtAccess or service: start Sm@rtServer	Disabled	Operate as OPC server	Disabled	OPC server type	OPC Unified Architecture Server
Sm@rtAccess: SIMATIC HMI HTTP server	Disabled	Sm@rtAccess: Web service (SOAP)	Disabled	Sm@rtService: HTML pages	Disabled
Name of SMTP server		Port	25	Name of the SMTP sender	
SMTP authentication		SMTP login		Secure connection for SMTP	Disabled

Screens

Bit selection for appearance analysis	Off	Bit selection for text and graphic lists	Off	Display limit values as a tooltip	Enabled
Show script comments	Enabled	Scrolling mode	Scroll bar		

Keyboard

Use screen keyboard	Disabled	Release button on exit	Disabled	Disable dialog window function keys	Disabled
---------------------	----------	------------------------	----------	-------------------------------------	----------

Good Manufacturing Practice

Configuration conforms to GMP	Disabled
-------------------------------	----------

Alarms

Controller alarms

Buffer overflow	10 %	Acknowledgment group text	QGR	Reporting	Enabled
Use alarm class color	Disabled	Use help texts for system diagnostics	Enabled	System event duration	2 Seconds
S7 diagnostic alarms with numbers only	Disabled	S7 diagnostic alarms with numbers and texts	Disabled	SIMOTION diagnostic alarms	Disabled
Connection	HMI_Connection_1	Display classes	0-16		

User administration

Change initial password	Disabled	Change logoff time	Enabled	Enable limit for logon attempts	Enabled
Invalid logon attempts	3	Logon with password	Disabled	Group-specific rights	Disabled
Password aging	Disabled	Validity period	90	Warning period	7
Password generations	3	At least one special character	Disabled	At least one number	Disabled
Minimum password length	3	SIMATIC Logon	Disabled	Apply user administration from	WinDomain
Server name		Port number	16389	Windows domain	
Encrypted SIMATIC Logon	Enabled				

Language & font

Preset runtime language	English (United States)
-------------------------	-------------------------

English (United States)

Runtime language	Enabled	Default font	Tahoma, 13 Pixel
------------------	---------	--------------	------------------

OPC settings

OPC UA server port number	4870	OPC UA server URL	opc.tcp://[HostName]:4870	No OPC UA server security	Enabled
No OPC UA server security	Enabled	OPC UA server with 128-bit RSA cryptographic system	Enabled	OPC UA server with 128-bit RSA cryptographic system without signature	Disabled
OPC UA server with 128-bit RSA cryptographic system for signatures	Disabled	OPC UA server with 128-bit cryptographic system for signatures and encryption	Enabled		

Instrumentation Tools

Totally Integrated Automation Portal		
--------------------------------------	--	--

Tag settings

Replace the separators on each sub-level of the path of the PLC tag:	Enabled	Compatibility mode: Set '_' between the PLC tags and the first-level element.	Disabled	Replace the '.' character if the name of the HMI tag is created from the PLC tag name	Enabled
Use '_' as the replacement character	Enabled	Use ';' as the replacement character	Disabled	Replace the characters '[' and ']' if the name of the HMI tag is created from the PLC tag name	Enabled
Use '{' and '}' as replacement characters	Enabled	Use '(' and ')' as replacement characters	Disabled		

Settings for the prefix 'PLC' in the HMI tag name

Connection	HMI_Connection_1	PLC name as prefix in the HMI tag name	Disabled
------------	------------------	--	----------

PID_PWM and PID_Output / PC station [SIMATIC PC station] / HMI_RT_1 [WinCC RT Advanced] / Screens Control

Hardcopy of Control

PID_Output

Set Point

Proportial gain

Integral gain

Deravative gain

OutFlow

Disturbance

Idle Time

OUTPTUT

Pump flow

PID_PWM

Set Point

Proportial gain

Integral gain

Deravative gain

OutFlow

Disturbance

Idle Time

OUTPTUT

Pump flow

General					
Name	Control	Background color	182, 182, 182	Grid color	0, 0, 0
Number	1	Template		Tooltip	
Release button					

Layers	
Active layer	0

Layer_0	Enabled
Layer_1	Enabled
Layer_2	Enabled
Layer_3	Enabled
Layer_4	Enabled
Layer_5	Enabled
Layer_6	Enabled
Layer_7	Enabled
Layer_8	Enabled
Layer_9	Enabled
Layer_10	Enabled
Layer_11	Enabled
Layer_12	Enabled
Layer_13	Enabled
Layer_14	Enabled
Layer_15	Enabled
Layer_16	Enabled
Layer_17	Enabled
Layer_18	Enabled
Layer_19	Enabled
Layer_20	Enabled
Layer_21	Enabled
Layer_22	Enabled
Layer_23	Enabled
Layer_24	Enabled
Layer_25	Enabled
Layer_26	Enabled
Layer_27	Enabled
Layer_28	Enabled
Layer_29	Enabled
Layer_30	Enabled
Layer_31	Enabled

Instrumentation Tools

Totally Integrated Automation Portal					
Bar_1					
Type	Bar				
General					
Maximum value	50	Minimum value	0	Process value	0
Appearance					
Foreground color	0, 122, 204	Background color of bar	0, 255, 255	Segment coloring	Entire bar
Background color	241, 241, 242	Background fill pattern	Solid	Color of scale	49, 52, 74
Limit lines (layout)	Disabled	Limit marking (layout)	Enabled		
Border type					
Compatibility mode (appearance)	Disabled	Border width	2	Border color	71, 73, 87
Border background color	101, 103, 115	Line style	3D style	Bar edge style	Solid
Corner radius (border)	4				
Scales					
Show scale	Enabled	Auto-scale	Disabled	Divisions	5
Large mark labeling	2	Scale gradation	10		
Label					
Show scale marks	Enabled	Show "+" for positive numbers	Disabled	Use exponential format	Disabled
Double-lined scale label	Disabled	Unit		Integer digits	2
Decimal places	0	Process tag	Enabled		
Layout					
X position	272	Y position	171	Width	290
Height	378	Inner dimensions width	1	Inner dimensions height	1
Scale position	Left/up	Bar orientation	Top		
Text format					
Font	Tahoma, 11px, style=Bold				
Flashing					
Flashing	Disabled	Flash on limit violation	Disabled		
Limits/Ranges					
Color range high 2	237, 88, 97	Show range Upper 2	Enabled	Color range low 2	241, 161, 44
Show range Lower 2	Enabled	Color range high 1	241, 161, 44	Show range Upper 1	Enabled
Color range low 1	241, 161, 44	Show range Lower 1	Enabled	Value range Lower 2	[0 - ?]
Value range Upper 2	[? - 50]	Range Normal color	56, 195, 70	Show range Normal	Enabled
Value range Normal]? - ?[Show ranges from tag	Disabled	Value range Lower 1]? - ?]
Value range Upper 1	[? - ?[
Styles/Designs					
Use style/design	Disabled	Style item appearance			
Miscellaneous					
Name	Bar_1	Layer	0 - Layer_0		
Dynamizations\Tag connection					
Property name	Process value	Tag	HMI DATA_FillLevel(in liters)		
Text field_1					
Type	Text field				
General					
Text	Set Point				
Appearance					
Background color	255, 255, 255	Background fill pattern	Transparent	Corner radius (border)	3
Foreground color	49, 52, 74	Border width	0	Line style	Double line
Border color	71, 73, 87	Border background color	101, 103, 115		
Layout					
X position	297	Y position	129	Width	73
Height	22	Left margin	3	Top margin	2
Right margin	2	Bottom margin	2	Fit object to contents	Enabled
Text format					
Font	Tahoma, 15px, style=Bold				
Vertical alignment	Middle	Orientation	Horizontal	Horizontal alignment	Left
		Line break	Disabled		
Flashing					
Flashing	Disabled				
Styles/Designs					
Use style/design	Disabled	Style item appearance			
Miscellaneous					
Name	Text field_1	Layer	0 - Layer_0		
I/O field_1					
Type	I/O field				
General					
Process value		Mode	Input/output	Display format	Decimal
Shift decimal point	0	Field length	6	Show leading zeros	Disabled
Format pattern	99.999				
Appearance					
Background color	255, 255, 255	Background fill pattern	Solid	Corner radius	3

Instrumentation Tools

Totally Integrated Automation Portal					
Foreground color	49, 52, 74	Unit	liters	Border width	4
Line style	Double line	Border color	71, 73, 87	Border background color	101, 103, 115
Characteristics					
Hidden input	Disabled				
Layout					
X position	397	Y position	124	Width	123
Height	32	Left margin	3	Top margin	2
Right margin	2	Bottom margin	2	Fit object to contents	Disabled
Text format					
Font	Tahoma, 15px, style=Bold	Orientation	Horizontal	Horizontal alignment	Left
Vertical alignment	Middle	Line break	Disabled		
Flashing					
Flashing	Disabled	Flash on limit violation	Disabled		
Limits					
Color for High limit violated	237, 88, 97	Color for Low limit violated	241, 161, 44		
Styles/Designs					
Use style/design	Disabled	Style item appearance			
Miscellaneous					
Name	I/O field_1	Layer	0 - Layer_0	Tooltip	
Security					
Authorization		Allow operator control	Enabled	Two-hand operation	Disabled
Dynamizations\Tag connection					
Property name	Process value	Tag	HMI DATA_Setpoint(in liters)		
Text field_3					
Type	Text field				
General					
Text	OutFlow				
Appearance					
Background color	255, 255, 255	Background fill pattern	Transparent	Corner radius (border)	3
Foreground color	49, 52, 74	Border width	0	Line style	Double line
Border color	71, 73, 87	Border background color	101, 103, 115		
Layout					
X position	29	Y position	358	Width	68
Height	22	Left margin	3	Top margin	2
Right margin	2	Bottom margin	2	Fit object to contents	Enabled
Text format					
Font	Tahoma, 15px, style=Bold	Orientation	Horizontal	Horizontal alignment	Left
Vertical alignment	Middle	Line break	Disabled		
Flashing					
Flashing	Disabled				
Styles/Designs					
Use style/design	Disabled	Style item appearance			
Miscellaneous					
Name	Text field_3	Layer	0 - Layer_0		
I/O field_3					
Type	I/O field				
General					
Process value		Mode	Input/output	Display format	Decimal
Shift decimal point	0	Field length	6	Show leading zeros	Disabled
Format pattern	999.99				
Appearance					
Background color	255, 255, 255	Background fill pattern	Solid	Corner radius	3
Foreground color	49, 52, 74	Unit	%/sec	Border width	4
Line style	Double line	Border color	71, 73, 87	Border background color	101, 103, 115
Characteristics					
Hidden input	Disabled				
Layout					
X position	126	Y position	352	Width	125
Height	32	Left margin	3	Top margin	2
Right margin	2	Bottom margin	2	Fit object to contents	Disabled
Text format					
Font	Tahoma, 15px, style=Bold	Orientation	Horizontal	Horizontal alignment	Left
Vertical alignment	Middle	Line break	Disabled		
Flashing					
Flashing	Disabled	Flash on limit violation	Disabled		
Limits					
Color for High limit violated	237, 88, 97	Color for Low limit violated	241, 161, 44		
Styles/Designs					
Use style/design	Disabled	Style item appearance			
Miscellaneous					
Name	I/O field_3	Layer	0 - Layer_0	Tooltip	

Instrumentation Tools

Totally Integrated Automation Portal					
Security					
Authorization		Allow operator control	Enabled	Two-hand operation	Disabled
Dynamizations\Tag connection					
Property name	Process value	Tag	HMI DATA_Disturbance flow (%/sec)		
Text field_4					
Type	Text field				
General					
Text	Disturbance				
Appearance					
Background color	255, 255, 255	Background fill pattern	Transparent	Corner radius (border)	3
Foreground color	49, 52, 74	Border width	0	Line style	Double line
Border color	71, 73, 87	Border background color	101, 103, 115		
Layout					
X position	10	Y position	400	Width	95
Height	22	Left margin	3	Top margin	2
Right margin	2	Bottom margin	2	Fit object to contents	Enabled
Text format					
Font	Tahoma, 15px, style=Bold		Orientation	Horizontal	
Vertical alignment	Middle	Line break	Disabled		
Flashing					
Flashing	Disabled				
Styles/Designs					
Use style/design	Disabled		Style item appearance		
Miscellaneous					
Name	Text field_4	Layer	0 - Layer_0		
Text field_5					
Type	Text field				
General					
Text	Idle Time				
Appearance					
Background color	255, 255, 255	Background fill pattern	Transparent	Corner radius (border)	3
Foreground color	49, 52, 74	Border width	0	Line style	Double line
Border color	71, 73, 87	Border background color	101, 103, 115		
Layout					
X position	17	Y position	461	Width	75
Height	22	Left margin	3	Top margin	2
Right margin	2	Bottom margin	2	Fit object to contents	Enabled
Text format					
Font	Tahoma, 15px, style=Bold		Orientation	Horizontal	
Vertical alignment	Middle	Line break	Disabled		
Flashing					
Flashing	Disabled				
Styles/Designs					
Use style/design	Disabled		Style item appearance		
Miscellaneous					
Name	Text field_5	Layer	0 - Layer_0		
I/O field_5					
Type	I/O field				
General					
Process value		Mode	Input/output	Display format	Decimal
Shift decimal point	0	Field length	4	Show leading zeros	Disabled
Format pattern	9999				
Appearance					
Background color	255, 255, 255	Background fill pattern	Solid	Corner radius	3
Foreground color	49, 52, 74	Unit	ms	Border width	4
Line style	Double line	Border color	71, 73, 87	Border background color	101, 103, 115
Characteristics					
Hidden input	Disabled				
Layout					
X position	124	Y position	455	Width	125
Height	32	Left margin	3	Top margin	2
Right margin	2	Bottom margin	2	Fit object to contents	Disabled
Text format					
Font	Tahoma, 15px, style=Bold		Orientation	Horizontal	
Vertical alignment	Middle	Line break	Disabled		
Flashing					
Flashing	Disabled	Flash on limit violation	Disabled		
Limits					
Color for High limit violated	237, 88, 97	Color for Low limit violated	241, 161, 44		
Styles/Designs					
Use style/design	Disabled		Style item appearance		

Instrumentation Tools

Totally Integrated Automation Portal					
Miscellaneous					
Name	I/O field_5	Layer	0 - Layer_0	Tooltip	
Security					
Authorization		Allow operator control	Enabled	Two-hand operation	Disabled
Dynamizations\Tag connection					
Property name	Process value	Tag	HMI DATA_IdleTime(ms)		
Symbolic I/O field_2					
Type	Symbolic I/O field				
General					
Process value	0	Bit number	0	Mode	Input/output
Value status ON	1	Text OFF	0	Text ON	1
Text list	Random Disturbance	Number of visible items	4		
Appearance					
Background color	255, 255, 255	Background fill pattern	Solid	Foreground color	49, 52, 74
Border width	4	Line style	Double line	Border color	71, 73, 87
Border background color	101, 103, 115				
Design					
Foreground color of selection	255, 255, 255	Background color of selection	0, 0, 0	Alternative color	230, 230, 232
Layout					
X position	125	Y position	396	Width	124
Height	35	Left margin	3	Top margin	2
Right margin	2	Bottom margin	2	Fit object to contents	Disabled
Display selection list	Enabled	Show selection field	Enabled		
Text format					
Font	Tahoma, 15px, style=Bold	Orientation	Horizontal	Horizontal alignment	Left
Vertical alignment	Middle				
Flashing					
Flashing	Disabled	Flash on limit violation	Disabled		
Limits					
Color for High limit violated	237, 88, 97	Color for Low limit violated	241, 161, 44		
Styles/Designs					
Use style/design	Disabled	Style item appearance			
Miscellaneous					
Name	Symbolic I/O field_2	Layer	0 - Layer_0	Tooltip	
Security					
Authorization		Allow operator control	Enabled		
Dynamizations\Tag connection					
Property name	Process value	Tag	HMI DATA_RandomNoise		
Button_1					
Type	Button				
General					
Mode	Text	Hotkey	None	Text OFF	Empty Tank
Text ON	Text	Text list		Graphic OFF	
Graphic ON		Graphic list		Process value	
Bit number	0				
Appearance					
Background color	51, 51, 153	Background fill pattern	Solid	Corner radius (border)	3
Foreground color	255, 255, 255	Border width	4	Line style	Solid
Border color	0, 0, 0	Border background color	105, 105, 105		
Fill pattern					
Background color gradient (fill pattern)	99, 101, 113	Gradient 1 (fill pattern)	Enabled	Color gradient 1 (fill pattern)	131, 132, 142
Offset gradient 1 (fill pattern)	15	Gradient 2 (fill pattern)	Enabled	Color gradient 2 (fill pattern)	88, 90, 103
Offset gradient 2 (fill pattern)	15				
Design					
Focus width	2	Focus color	148, 182, 231		
Layout					
X position	270	Y position	565	Width	292
Height	54	Fit graphic to size	Stretch graphic	Horizontal alignment of the graphic	Centered
Vertical alignment of the graphic	Middle	Fit object to contents	Disabled	Margin left text (layout)	0
Margin top text (layout)	0	Margin right text (layout)	0	Margin bottom text (layout)	0
Margin left graphic (layout)	0	Margin top graphic (layout)	0	Margin right graphic (layout)	0
Margin bottom graphic (layout)	0				
Text format					
Font	Tahoma, 15px, style=Bold	Orientation	Horizontal	Horizontal alignment of the text	Centered
Vertical alignment of the text	Middle				

Instrumentation Tools

Totally Integrated Automation Portal							
Flashing							
Flashing	Disabled						
Styles/Designs							
Use style/design	Disabled		Style item appearance				
Miscellaneous							
Name	Button_1	Layer	0 - Layer_0		Tooltip		
Security							
Authorization		Allow operator control	Enabled		Two-hand operation	Disabled	
Dynamizations\Event							
Event name	Press						
Function list\SetBitWhileKeyPressed							
Tag	HMI DATA_EmptyTank		Bit	0			
Text field_6							
Type	Text field						
General							
Text	PID_Output						
Appearance							
Background color	153, 204, 255		Background fill pattern	Solid		Corner radius (border)	3
Foreground color	49, 52, 74		Border width	0		Line style	Double line
Border color	71, 73, 87		Border background color	101, 103, 115			
Layout							
X position	5		Y position	26		Width	556
Height	90		Left margin	5		Top margin	2
Right margin	2		Bottom margin	2		Fit object to contents	Disabled
Text format							
Font	Tahoma, 36px, style=Bold		Orientation	Horizontal		Horizontal alignment	Centered
Vertical alignment	Middle		Line break	Disabled			
Flashing							
Flashing	Disabled						
Styles/Designs							
Use style/design	Disabled		Style item appearance				
Miscellaneous							
Name	Text field_6	Layer	0 - Layer_0				
Text field_2							
Type	Text field						
General							
Text	Proportial gain						
Appearance							
Background color	255, 255, 255		Background fill pattern	Transparent		Corner radius (border)	3
Foreground color	49, 52, 74		Border width	0		Line style	Double line
Border color	71, 73, 87		Border background color	101, 103, 115			
Layout							
X position	12		Y position	182		Width	117
Height	22		Left margin	3		Top margin	2
Right margin	2		Bottom margin	2		Fit object to contents	Enabled
Text format							
Font	Tahoma, 15px, style=Bold		Orientation	Horizontal		Horizontal alignment	Left
Vertical alignment	Middle		Line break	Disabled			
Flashing							
Flashing	Disabled						
Styles/Designs							
Use style/design	Disabled		Style item appearance				
Miscellaneous							
Name	Text field_2	Layer	0 - Layer_0				
Text field_7							
Type	Text field						
General							
Text	Integral gain						
Appearance							
Background color	255, 255, 255		Background fill pattern	Transparent		Corner radius (border)	3
Foreground color	49, 52, 74		Border width	0		Line style	Double line
Border color	71, 73, 87		Border background color	101, 103, 115			
Layout							
X position	12		Y position	226		Width	102
Height	22		Left margin	3		Top margin	2
Right margin	2		Bottom margin	2		Fit object to contents	Enabled
Text format							
Font	Tahoma, 15px, style=Bold		Orientation	Horizontal		Horizontal alignment	Left
Vertical alignment	Middle		Line break	Disabled			

Instrumentation Tools

Totally Integrated Automation Portal					
Flashing					
Flashing	Disabled				
Styles/Designs					
Use style/design	Disabled		Style item appearance		
Miscellaneous					
Name	Text field_7	Layer	0 - Layer_0		
Text field_8					
Type	Text field				
General					
Text	Deravative gain				
Appearance					
Background color	255, 255, 255	Background fill pattern	Transparent	Corner radius (border)	3
Foreground color	49, 52, 74	Border width	0	Line style	Double line
Border color	71, 73, 87	Border background color	101, 103, 115		
Layout					
X position	12	Y position	278	Width	124
Height	22	Left margin	3	Top margin	2
Right margin	2	Bottom margin	2	Fit object to contents	Enabled
Text format					
Font	Tahoma, 15px, style=Bold		Orientation	Horizontal	
Vertical alignment	Middle	Line break	Disabled		
Flashing					
Flashing	Disabled				
Styles/Designs					
Use style/design	Disabled		Style item appearance		
Miscellaneous					
Name	Text field_8	Layer	0 - Layer_0		
I/O field_8					
Type	I/O field				
General					
Process value		Mode	Output	Display format	Decimal
Shift decimal point	0	Field length	7	Show leading zeros	Disabled
Format pattern	999.999				
Appearance					
Background color	255, 255, 255	Background fill pattern	Solid	Corner radius	3
Foreground color	49, 52, 74	Unit	%	Border width	4
Line style	Double line	Border color	71, 73, 87		
Characteristics					
Hidden input	Disabled				
Layout					
X position	107	Y position	529	Width	123
Height	32	Left margin	3	Top margin	2
Right margin	2	Bottom margin	2	Fit object to contents	Disabled
Text format					
Font	Tahoma, 15px, style=Bold		Orientation	Horizontal	
Vertical alignment	Middle	Line break	Disabled		
Flashing					
Flashing	Disabled		Flash on limit violation	Disabled	
Limits					
Color for High limit violated	237, 88, 97		Color for Low limit violated	241, 161, 44	
Styles/Designs					
Use style/design	Disabled		Style item appearance		
Miscellaneous					
Name	I/O field_8	Layer	0 - Layer_0	Tooltip	
Security					
Authorization		Allow operator control	Enabled	Two-hand operation	Disabled
Dynamizations\Tag connection					
Property name	Process value	Tag	PID_Compact_1_Output		
Text field_10					
Type	Text field				
General					
Text	OUTPTUT				
Appearance					
Background color	255, 255, 255	Background fill pattern	Transparent	Corner radius (border)	3
Foreground color	49, 52, 74	Border width	0	Line style	Double line
Border color	71, 73, 87	Border background color	101, 103, 115		
Layout					
X position	17	Y position	534	Width	76
Height	22	Left margin	3	Top margin	2
Right margin	2	Bottom margin	2	Fit object to contents	Enabled

Instrumentation Tools

Totally Integrated Automation Portal					
Text format					
Font	Tahoma, 15px, style=Bold	Orientation	Horizontal	Horizontal alignment	Left
Vertical alignment	Middle	Line break	Disabled		
Flashing					
Flashing	Disabled				
Styles/Designs					
Use style/design	Disabled	Style item appearance			
Miscellaneous					
Name	Text field_10	Layer	0 - Layer_0		
I/O field_9					
Type	I/O field				
General					
Process value		Mode	Output	Display format	Decimal
Shift decimal point	0	Field length	7	Show leading zeros	Disabled
Format pattern	999.999				
Appearance					
Background color	255, 255, 255	Background fill pattern	Solid	Corner radius	3
Foreground color	49, 52, 74	Unit		Border width	4
Line style	Double line	Border color	71, 73, 87	Border background color	101, 103, 115
Characteristics					
Hidden input	Disabled				
Layout					
X position	107	Y position	568	Width	123
Height	32	Left margin	3	Top margin	2
Right margin	2	Bottom margin	2	Fit object to contents	Disabled
Text format					
Font	Tahoma, 15px, style=Bold	Orientation	Horizontal	Horizontal alignment	Left
Vertical alignment	Middle	Line break	Disabled		
Flashing					
Flashing	Disabled	Flash on limit violation	Disabled		
Limits					
Color for High limit violated	237, 88, 97	Color for Low limit violated	241, 161, 44		
Styles/Designs					
Use style/design	Disabled	Style item appearance			
Miscellaneous					
Name	I/O field_9	Layer	0 - Layer_0	Tooltip	
Security					
Authorization		Allow operator control	Enabled	Two-hand operation	Disabled
Dynamizations\Tag connection					
Property name	Process value	Tag	HMI DATA_PumpFlow(liters/sec)		
Text field_11					
Type	Text field				
General					
Text	Pump flow				
Appearance					
Background color	255, 255, 255	Background fill pattern	Transparent	Corner radius (border)	3
Foreground color	49, 52, 74	Border width	0	Line style	Double line
Border color	71, 73, 87	Border background color	101, 103, 115		
Layout					
X position	17	Y position	573	Width	83
Height	22	Left margin	3	Top margin	2
Right margin	2	Bottom margin	2	Fit object to contents	Enabled
Text format					
Font	Tahoma, 15px, style=Bold	Orientation	Horizontal	Horizontal alignment	Left
Vertical alignment	Middle	Line break	Disabled		
Flashing					
Flashing	Disabled				
Styles/Designs					
Use style/design	Disabled	Style item appearance			
Miscellaneous					
Name	Text field_11	Layer	0 - Layer_0		
I/O field_2					
Type	I/O field				
General					
Process value		Mode	Input/output	Display format	Decimal
Shift decimal point	0	Field length	13	Show leading zeros	Disabled
Format pattern	s999999999.999				
Appearance					
Background color	255, 255, 255	Background fill pattern	Solid	Corner radius	3
Foreground color	49, 52, 74	Unit		Border width	4
Line style	Double line	Border color	71, 73, 87	Border background color	101, 103, 115

Instrumentation Tools

Totally Integrated Automation Portal					
Characteristics					
Hidden input	Disabled				
Layout					
X position	162	Y position	169	Width	96
Height	32	Left margin	3	Top margin	2
Right margin	2	Bottom margin	2	Fit object to contents	Disabled
Text format					
Font	Tahoma, 15px, style=Bold		Orientation	Horizontal	
Vertical alignment	Middle		Line break	Disabled	
Flashing					
Flashing	Disabled		Flash on limit violation	Disabled	
Limits					
Color for High limit violated	237, 88, 97		Color for Low limit violated	241, 161, 44	
Styles/Designs					
Use style/design	Disabled		Style item appearance		
Miscellaneous					
Name	I/O field_2	Layer	0 - Layer_0		Tooltip
Security					
Authorization			Allow operator control	Enabled	Two-hand operation Disabled
Dynamizations\Tag connection					
Property name	Process value	Tag	PID_Compact_1_Retain_CtrlParams_Gain		
I/O field_4					
Type	I/O field				
General					
Process value			Mode	Input/output	
Shift decimal point	0		Field length	13	
Format pattern	s999999999.999				
Appearance					
Background color	255, 255, 255		Background fill pattern	Solid	
Foreground color	49, 52, 74		Unit		
Line style	Double line		Border color	71, 73, 87	
			Corner radius	3	
			Border width	4	
			Border background color	101, 103, 115	
Characteristics					
Hidden input	Disabled				
Layout					
X position	162	Y position	216	Width	96
Height	32	Left margin	3	Top margin	2
Right margin	2	Bottom margin	2	Fit object to contents	Disabled
Text format					
Font	Tahoma, 15px, style=Bold		Orientation	Horizontal	
Vertical alignment	Middle		Line break	Disabled	
Flashing					
Flashing	Disabled		Flash on limit violation	Disabled	
Limits					
Color for High limit violated	237, 88, 97		Color for Low limit violated	241, 161, 44	
Styles/Designs					
Use style/design	Disabled		Style item appearance		
Miscellaneous					
Name	I/O field_4	Layer	0 - Layer_0		Tooltip
Security					
Authorization			Allow operator control	Enabled	Two-hand operation Disabled
Dynamizations\Tag connection					
Property name	Process value	Tag	PID_Compact_1_Retain_CtrlParams_Ti		
I/O field_6					
Type	I/O field				
General					
Process value			Mode	Input/output	
Shift decimal point	0		Field length	13	
Format pattern	s999999999.999				
Appearance					
Background color	255, 255, 255		Background fill pattern	Solid	
Foreground color	49, 52, 74		Unit		
Line style	Double line		Border color	71, 73, 87	
			Corner radius	3	
			Border width	4	
			Border background color	101, 103, 115	
Characteristics					
Hidden input	Disabled				
Layout					
X position	162	Y position	274	Width	96
Height	32	Left margin	3	Top margin	2
Right margin	2	Bottom margin	2	Fit object to contents	Disabled
Text format					
Font	Tahoma, 15px, style=Bold		Orientation	Horizontal	
Vertical alignment	Middle		Line break	Disabled	

Instrumentation Tools

Totally Integrated Automation Portal						
Flashing						
Flashing	Disabled	Flash on limit violation	Disabled			
Limits						
Color for High limit violated	237, 88, 97	Color for Low limit violated	241, 161, 44			
Styles/Designs						
Use style/design	Disabled	Style item appearance				
Miscellaneous						
Name	I/O field_6	Layer	0 - Layer_0	Tooltip		
Security						
Authorization		Allow operator control	Enabled	Two-hand operation	Disabled	
Dynamizations/Tag connection						
Property name	Process value	Tag	PID_Compact_1_Retain_CtrlParams_Td			
Text field_9						
Type	Text field					
General						
Text	PID_PWM					
Appearance						
Background color	153, 204, 255	Background fill pattern	Solid	Corner radius (border)	3	
Foreground color	49, 52, 74	Border width	0	Line style	Double line	
Border color	71, 73, 87	Border background color	101, 103, 115			
Layout						
X position	612	Y position	28	Width	646	
Height	90	Left margin	5	Top margin	2	
Right margin	2	Bottom margin	2	Fit object to contents	Disabled	
Text format						
Font	Tahoma, 36px, style=Bold		Orientation	Horizontal		
Vertical alignment	Middle		Line break	Disabled		
Flashing						
Flashing	Disabled					
Styles/Designs						
Use style/design	Disabled		Style item appearance			
Miscellaneous						
Name	Text field_9		Layer	0 - Layer_0		
Bar_2						
Type	Bar					
General						
Maximum value	50	Minimum value	0	Process value	0	
Appearance						
Foreground color	0, 122, 204	Background color of bar	0, 255, 255	Segment coloring	Entire bar	
Background color	241, 241, 242	Background fill pattern	Solid	Color of scale	49, 52, 74	
Limit lines (layout)	Disabled		Limit marking (layout)	Enabled		
Border type						
Compatibility mode (appearance)	Disabled		Border width	2	Border color	71, 73, 87
Border background color	101, 103, 115		Line style	3D style		
Corner radius (border)	4					
Scales						
Show scale	Enabled		Auto-scale	Disabled		
Large mark labeling	2		Scale gradation	10		
Label						
Show scale marks	Enabled		Show "+" for positive numbers	Disabled		
Double-lined scale label	Disabled		Unit			
Decimal places	0		Process tag	Enabled		
Layout						
X position	919	Y position	180	Width	290	
Height	378	Inner dimensions width	1	Inner dimensions height	1	
Scale position	Left/up		Bar orientation	Top		
Text format						
Font	Tahoma, 11px, style=Bold					
Flashing						
Flashing	Disabled					
Limits/Ranges						
Color range high 2	237, 88, 97	Show range Upper 2	Enabled	Color range low 2	241, 161, 44	
Show range Lower 2	Enabled		Color range high 1	241, 161, 44		
Color range low 1	241, 161, 44		Show range Lower 1	Enabled		
Value range Upper 2	[? - 50]		Range Normal color	56, 195, 70		
Value range Normal]? - ?[Show ranges from tag	Disabled		
Value range Upper 1]? - ?[Value range Lower 1]? - ?[

Instrumentation Tools

Totally Integrated Automation Portal					
Styles/Designs					
Use style/design	Disabled	Style item appearance			
Miscellaneous					
Name	Bar_2	Layer	0 - Layer_0		
Dynamizations\Tag connection					
Property name	Process value	Tag	HMI DATA_FillLevel(in liters)_2		
Text field_12					
Type	Text field				
General					
Text	Set Point				
Appearance					
Background color	255, 255, 255	Background fill pattern	Transparent	Corner radius (border)	3
Foreground color	49, 52, 74	Border width	0	Line style	Double line
Border color	71, 73, 87	Border background color	101, 103, 115		
Layout					
X position	944	Y position	138	Width	73
Height	22	Left margin	3	Top margin	2
Right margin	2	Bottom margin	2	Fit object to contents	Enabled
Text format					
Font	Tahoma, 15px, style=Bold		Orientation	Horizontal	
Vertical alignment	Middle		Line break	Disabled	
Flashing					
Flashing	Disabled				
Styles/Designs					
Use style/design	Disabled	Style item appearance			
Miscellaneous					
Name	Text field_12	Layer	0 - Layer_0		
I/O field_7					
Type	I/O field				
General					
Process value		Mode	Input/output	Display format	Decimal
Shift decimal point	0	Field length	6	Show leading zeros	Disabled
Format pattern	99.999				
Appearance					
Background color	255, 255, 255	Background fill pattern	Solid	Corner radius	3
Foreground color	49, 52, 74	Unit	liters	Border width	4
Line style	Double line	Border color	71, 73, 87	Border background color	101, 103, 115
Characteristics					
Hidden input	Disabled				
Layout					
X position	1044	Y position	133	Width	123
Height	32	Left margin	3	Top margin	2
Right margin	2	Bottom margin	2	Fit object to contents	Disabled
Text format					
Font	Tahoma, 15px, style=Bold		Orientation	Horizontal	
Vertical alignment	Middle		Line break	Disabled	
Flashing					
Flashing	Disabled	Flash on limit violation	Disabled		
Limits					
Color for High limit violated	237, 88, 97	Color for Low limit violated	241, 161, 44		
Styles/Designs					
Use style/design	Disabled	Style item appearance			
Miscellaneous					
Name	I/O field_7	Layer	0 - Layer_0	Tooltip	
Security					
Authorization		Allow operator control	Enabled	Two-hand operation	Disabled
Dynamizations\Tag connection					
Property name	Process value	Tag	HMI DATA_Setpoint(in liters)_2		
Text field_13					
Type	Text field				
General					
Text	OutFlow				
Appearance					
Background color	255, 255, 255	Background fill pattern	Transparent	Corner radius (border)	3
Foreground color	49, 52, 74	Border width	0	Line style	Double line
Border color	71, 73, 87	Border background color	101, 103, 115		
Layout					
X position	689	Y position	385	Width	68
Height	22	Left margin	3	Top margin	2
Right margin	2	Bottom margin	2	Fit object to contents	Enabled

Instrumentation Tools

Totally Integrated Automation Portal					
Text format					
Font	Tahoma, 15px, style=Bold	Orientation	Horizontal	Horizontal alignment	Left
Vertical alignment	Middle	Line break	Disabled		
Flashing					
Flashing	Disabled				
Styles/Designs					
Use style/design	Disabled	Style item appearance			
Miscellaneous					
Name	Text field_13	Layer	0 - Layer_0		
Text field_14					
Type	Text field				
General					
Text	Disturbance				
Appearance					
Background color	255, 255, 255	Background fill pattern	Transparent	Corner radius (border)	3
Foreground color	49, 52, 74	Border width	0	Line style	Double line
Border color	71, 73, 87	Border background color	101, 103, 115		
Layout					
X position	656	Y position	425	Width	95
Height	22	Left margin	3	Top margin	2
Right margin	2	Bottom margin	2	Fit object to contents	Enabled
Text format					
Font	Tahoma, 15px, style=Bold	Orientation	Horizontal	Horizontal alignment	Left
Vertical alignment	Middle	Line break	Disabled		
Flashing					
Flashing	Disabled				
Styles/Designs					
Use style/design	Disabled	Style item appearance			
Miscellaneous					
Name	Text field_14	Layer	0 - Layer_0		
Text field_15					
Type	Text field				
General					
Text	Idle Time				
Appearance					
Background color	255, 255, 255	Background fill pattern	Transparent	Corner radius (border)	3
Foreground color	49, 52, 74	Border width	0	Line style	Double line
Border color	71, 73, 87	Border background color	101, 103, 115		
Layout					
X position	656	Y position	480	Width	75
Height	22	Left margin	3	Top margin	2
Right margin	2	Bottom margin	2	Fit object to contents	Enabled
Text format					
Font	Tahoma, 15px, style=Bold	Orientation	Horizontal	Horizontal alignment	Left
Vertical alignment	Middle	Line break	Disabled		
Flashing					
Flashing	Disabled				
Styles/Designs					
Use style/design	Disabled	Style item appearance			
Miscellaneous					
Name	Text field_15	Layer	0 - Layer_0		
Symbolic I/O field_1					
Type	Symbolic I/O field				
General					
Process value	0	Bit number	0	Mode	Input/output
Value status ON	1	Text OFF	0	Text ON	1
Text list	Random Disturbance	Number of visible items	4		
Appearance					
Background color	255, 255, 255	Background fill pattern	Solid	Foreground color	49, 52, 74
Border width	4	Line style	Double line	Border color	71, 73, 87
Border background color	101, 103, 115				
Design					
Foreground color of selection	255, 255, 255	Background color of selection	0, 0, 0	Alternative color	230, 230, 232
Layout					
X position	755	Y position	419	Width	124
Height	35	Left margin	3	Top margin	2
Right margin	2	Bottom margin	2	Fit object to contents	Disabled
Display selection list	Enabled	Show selection field	Enabled		
Text format					
Font	Tahoma, 15px, style=Bold	Orientation	Horizontal	Horizontal alignment	Left
Vertical alignment	Middle				

Instrumentation Tools

Totally Integrated Automation Portal					
Flashing					
Flashing	Disabled	Flash on limit violation	Disabled		
Limits					
Color for High limit violated	237, 88, 97	Color for Low limit violated	241, 161, 44		
Styles/Designs					
Use style/design	Disabled	Style item appearance			
Miscellaneous					
Name	Symbolic I/O field_1	Layer	0 - Layer_0	Tooltip	
Security					
Authorization		Allow operator control	Enabled		
Dynamizations\Tag connection					
Property name	Process value	Tag	HMI DATA_RandomNoise_2		
Button_2					
Type	Button				
General					
Mode	Text	Hotkey	None	Text OFF	Empty Tank
Text ON	Text	Text list		Graphic OFF	
Graphic ON		Graphic list		Process value	
Bit number	0				
Appearance					
Background color	51, 51, 153	Background fill pattern	Solid	Corner radius (border)	3
Foreground color	255, 255, 255	Border width	4	Line style	Solid
Border color	0, 0, 0	Border background color	105, 105, 105		
Fill pattern					
Background color gradient (fill pattern)	99, 101, 113	Gradient 1 (fill pattern)	Enabled	Color gradient 1 (fill pattern)	131, 132, 142
Offset gradient 1 (fill pattern)	15	Gradient 2 (fill pattern)	Enabled	Color gradient 2 (fill pattern)	88, 90, 103
Offset gradient 2 (fill pattern)	15				
Design					
Focus width	2	Focus color	148, 182, 231		
Layout					
X position	917	Y position	564	Width	292
Height	54	Fit graphic to size	Stretch graphic	Horizontal alignment of the graphic	Centered
Vertical alignment of the graphic	Middle	Fit object to contents	Disabled	Margin left text (layout)	0
Margin top text (layout)	0	Margin right text (layout)	0	Margin bottom text (layout)	0
Margin left graphic (layout)	0	Margin top graphic (layout)	0	Margin right graphic (layout)	0
Margin bottom graphic (layout)	0				
Text format					
Font	Tahoma, 15px, style=Bold	Orientation	Horizontal	Horizontal alignment of the text	Centered
Vertical alignment of the text	Middle				
Flashing					
Flashing	Disabled				
Styles/Designs					
Use style/design	Disabled	Style item appearance			
Miscellaneous					
Name	Button_2	Layer	0 - Layer_0	Tooltip	
Security					
Authorization		Allow operator control	Enabled	Two-hand operation	Disabled
Dynamizations\Event					
Event name	Press				
Function list\SetBitWhileKeyPressed					
Tag	HMI DATA_EmptyTank_2	Bit	0		
Text field_16					
Type	Text field				
General					
Text	Proportial gain				
Appearance					
Background color	255, 255, 255	Background fill pattern	Transparent	Corner radius (border)	3
Foreground color	49, 52, 74	Border width	0	Line style	Double line
Border color	71, 73, 87	Border background color	101, 103, 115		
Layout					
X position	620	Y position	185	Width	117
Height	22	Left margin	3	Top margin	2
Right margin	2	Bottom margin	2	Fit object to contents	Enabled

Instrumentation Tools

Totally Integrated Automation Portal					
Text format					
Font	Tahoma, 15px, style=Bold	Orientation	Horizontal	Horizontal alignment	Left
Vertical alignment	Middle	Line break	Disabled		
Flashing					
Flashing	Disabled				
Styles/Designs					
Use style/design	Disabled	Style item appearance			
Miscellaneous					
Name	Text field_16	Layer	0 - Layer_0		
Text field_17					
Type	Text field				
General					
Text	Integral gain				
Appearance					
Background color	255, 255, 255	Background fill pattern	Transparent	Corner radius (border)	3
Foreground color	49, 52, 74	Border width	0	Line style	Double line
Border color	71, 73, 87	Border background color	101, 103, 115		
Layout					
X position	620	Y position	233	Width	102
Height	22	Left margin	3	Top margin	2
Right margin	2	Bottom margin	2	Fit object to contents	Enabled
Text format					
Font	Tahoma, 15px, style=Bold	Orientation	Horizontal	Horizontal alignment	Left
Vertical alignment	Middle	Line break	Disabled		
Flashing					
Flashing	Disabled				
Styles/Designs					
Use style/design	Disabled	Style item appearance			
Miscellaneous					
Name	Text field_17	Layer	0 - Layer_0		
Text field_18					
Type	Text field				
General					
Text	Deravative gain				
Appearance					
Background color	255, 255, 255	Background fill pattern	Transparent	Corner radius (border)	3
Foreground color	49, 52, 74	Border width	0	Line style	Double line
Border color	71, 73, 87	Border background color	101, 103, 115		
Layout					
X position	613	Y position	278	Width	124
Height	22	Left margin	3	Top margin	2
Right margin	2	Bottom margin	2	Fit object to contents	Enabled
Text format					
Font	Tahoma, 15px, style=Bold	Orientation	Horizontal	Horizontal alignment	Left
Vertical alignment	Middle	Line break	Disabled		
Flashing					
Flashing	Disabled				
Styles/Designs					
Use style/design	Disabled	Style item appearance			
Miscellaneous					
Name	Text field_18	Layer	0 - Layer_0		
Text field_19					
Type	Text field				
General					
Text	OUTPTUT				
Appearance					
Background color	255, 255, 255	Background fill pattern	Transparent	Corner radius (border)	3
Foreground color	49, 52, 74	Border width	0	Line style	Double line
Border color	71, 73, 87	Border background color	101, 103, 115		
Layout					
X position	660	Y position	535	Width	76
Height	22	Left margin	3	Top margin	2
Right margin	2	Bottom margin	2	Fit object to contents	Enabled
Text format					
Font	Tahoma, 15px, style=Bold	Orientation	Horizontal	Horizontal alignment	Left
Vertical alignment	Middle	Line break	Disabled		
Flashing					
Flashing	Disabled				
Styles/Designs					
Use style/design	Disabled	Style item appearance			
Miscellaneous					
Name	Text field_19	Layer	0 - Layer_0		

Instrumentation Tools

Totally Integrated Automation Portal					
Text field_20					
Type	Text field				
General					
Text	Pump flow				
Appearance					
Background color	255, 255, 255	Background fill pattern	Transparent	Corner radius (border)	3
Foreground color	49, 52, 74	Border width	0	Line style	Double line
Border color	71, 73, 87	Border background color	101, 103, 115		
Layout					
X position	654	Y position	590	Width	83
Height	22	Left margin	3	Top margin	2
Right margin	2	Bottom margin	2	Fit object to contents	Enabled
Text format					
Font	Tahoma, 15px, style=Bold	Orientation	Horizontal	Horizontal alignment	Left
Vertical alignment	Middle	Line break	Disabled		
Flashing					
Flashing	Disabled				
Styles/Designs					
Use style/design	Disabled	Style item appearance			
Miscellaneous					
Name	Text field_20	Layer	0 - Layer_0		
I/O field_17					
Type	I/O field				
General					
Process value		Mode	Input/output	Display format	Decimal
Shift decimal point	0	Field length	13	Show leading zeros	Disabled
Format pattern	s999999999.999				
Appearance					
Background color	255, 255, 255	Background fill pattern	Solid	Corner radius	3
Foreground color	49, 52, 74	Unit		Border width	4
Line style	Double line	Border color	71, 73, 87	Border background color	101, 103, 115
Characteristics					
Hidden input	Disabled				
Layout					
X position	765	Y position	180	Width	96
Height	32	Left margin	3	Top margin	2
Right margin	2	Bottom margin	2	Fit object to contents	Disabled
Text format					
Font	Tahoma, 15px, style=Bold	Orientation	Horizontal	Horizontal alignment	Left
Vertical alignment	Middle	Line break	Disabled		
Flashing					
Flashing	Disabled	Flash on limit violation	Disabled		
Limits					
Color for High limit violated	237, 88, 97	Color for Low limit violated	241, 161, 44		
Styles/Designs					
Use style/design	Disabled	Style item appearance			
Miscellaneous					
Name	I/O field_17	Layer	0 - Layer_0	Tooltip	
Security					
Authorization		Allow operator control	Enabled	Two-hand operation	Disabled
Dynamizations\Tag connection					
Property name	Process value	Tag	PID_Compact_2_Retain_CtrlParams_Gain		
I/O field_14					
Type	I/O field				
General					
Process value		Mode	Input/output	Display format	Decimal
Shift decimal point	0	Field length	13	Show leading zeros	Disabled
Format pattern	s999999999.999				
Appearance					
Background color	255, 255, 255	Background fill pattern	Solid	Corner radius	3
Foreground color	49, 52, 74	Unit		Border width	4
Line style	Double line	Border color	71, 73, 87	Border background color	101, 103, 115
Characteristics					
Hidden input	Disabled				
Layout					
X position	766	Y position	231	Width	96
Height	32	Left margin	3	Top margin	2
Right margin	2	Bottom margin	2	Fit object to contents	Disabled
Text format					
Font	Tahoma, 15px, style=Bold	Orientation	Horizontal	Horizontal alignment	Left
Vertical alignment	Middle	Line break	Disabled		

Instrumentation Tools

Totally Integrated Automation Portal					
Flashing					
Flashing	Disabled	Flash on limit violation	Disabled		
Limits					
Color for High limit violated	237, 88, 97	Color for Low limit violated	241, 161, 44		
Styles/Designs					
Use style/design	Disabled	Style item appearance			
Miscellaneous					
Name	I/O field_14	Layer	0 - Layer_0	Tooltip	
Security					
Authorization		Allow operator control	Enabled	Two-hand operation	Disabled
Dynamizations\Tag connection					
Property name	Process value	Tag	PID_Compact_2_Retain_CtrlParams_Ti		
I/O field_15					
Type	I/O field				
General					
Process value		Mode	Input/output	Display format	Decimal
Shift decimal point	0	Field length	13	Show leading zeros	Disabled
Format pattern	s999999999.999				
Appearance					
Background color	255, 255, 255	Background fill pattern	Solid	Corner radius	3
Foreground color	49, 52, 74	Unit		Border width	4
Line style	Double line	Border color	71, 73, 87	Border background color	101, 103, 115
Characteristics					
Hidden input	Disabled				
Layout					
X position	765	Y position	278	Width	96
Height	32	Left margin	3	Top margin	2
Right margin	2	Bottom margin	2	Fit object to contents	Disabled
Text format					
Font	Tahoma, 15px, style=Bold	Orientation	Horizontal	Horizontal alignment	Left
Vertical alignment	Middle	Line break	Disabled		
Flashing					
Flashing	Disabled	Flash on limit violation	Disabled		
Limits					
Color for High limit violated	237, 88, 97	Color for Low limit violated	241, 161, 44		
Styles/Designs					
Use style/design	Disabled	Style item appearance			
Miscellaneous					
Name	I/O field_15	Layer	0 - Layer_0	Tooltip	
Security					
Authorization		Allow operator control	Enabled	Two-hand operation	Disabled
Dynamizations\Tag connection					
Property name	Process value	Tag	PID_Compact_2_Retain_CtrlParams_Td		
I/O field_16					
Type	I/O field				
General					
Process value		Mode	Input/output	Display format	Decimal
Shift decimal point	0	Field length	13	Show leading zeros	Disabled
Format pattern	s999999999.999				
Appearance					
Background color	255, 255, 255	Background fill pattern	Solid	Corner radius	3
Foreground color	49, 52, 74	Unit	%/sec	Border width	4
Line style	Double line	Border color	71, 73, 87	Border background color	101, 103, 115
Characteristics					
Hidden input	Disabled				
Layout					
X position	765	Y position	373	Width	96
Height	32	Left margin	3	Top margin	2
Right margin	2	Bottom margin	2	Fit object to contents	Disabled
Text format					
Font	Tahoma, 15px, style=Bold	Orientation	Horizontal	Horizontal alignment	Left
Vertical alignment	Middle	Line break	Disabled		
Flashing					
Flashing	Disabled	Flash on limit violation	Disabled		
Limits					
Color for High limit violated	237, 88, 97	Color for Low limit violated	241, 161, 44		
Styles/Designs					
Use style/design	Disabled	Style item appearance			

Instrumentation Tools

Totally Integrated Automation Portal					
Miscellaneous					
Name	I/O field_16	Layer	0 - Layer_0	Tooltip	
Security					
Authorization		Allow operator control	Enabled	Two-hand operation	Disabled
Dynamizations\Tag connection					
Property name	Process value	Tag	HMI DATA_Disturbance flow (%/sec)_2		
I/O field_10					
Type	I/O field				
General					
Process value		Mode	Input/output	Display format	Decimal
Shift decimal point	0	Field length	5	Show leading zeros	Disabled
Format pattern	s99999				
Appearance					
Background color	255, 255, 255	Background fill pattern	Solid	Corner radius	3
Foreground color	49, 52, 74	Unit		Border width	4
Line style	Double line	Border color	71, 73, 87	Border background color	101, 103, 115
Characteristics					
Hidden input	Disabled				
Layout					
X position	755	Y position	476	Width	96
Height	32	Left margin	3	Top margin	2
Right margin	2	Bottom margin	2	Fit object to contents	Disabled
Text format					
Font	Tahoma, 15px, style=Bold	Orientation	Horizontal	Horizontal alignment	Left
Vertical alignment	Middle	Line break	Disabled		
Flashing					
Flashing	Disabled				
		Flash on limit violation	Disabled		
Limits					
Color for High limit violated	237, 88, 97	Color for Low limit violated	241, 161, 44		
Styles/Designs					
Use style/design	Disabled				
		Style item appearance			
Miscellaneous					
Name	I/O field_10	Layer	0 - Layer_0	Tooltip	
Security					
Authorization		Allow operator control	Enabled	Two-hand operation	Disabled
Dynamizations\Tag connection					
Property name	Process value	Tag	HMI DATA_IdleTime(ms)_2		
I/O field_11					
Type	I/O field				
General					
Process value		Mode	Input/output	Display format	Decimal
Shift decimal point	0	Field length	13	Show leading zeros	Disabled
Format pattern	s999999999.999				
Appearance					
Background color	255, 255, 255	Background fill pattern	Solid	Corner radius	3
Foreground color	49, 52, 74	Unit		Border width	4
Line style	Double line	Border color	71, 73, 87	Border background color	101, 103, 115
Characteristics					
Hidden input	Disabled				
Layout					
X position	769	Y position	585	Width	96
Height	32	Left margin	3	Top margin	2
Right margin	2	Bottom margin	2	Fit object to contents	Disabled
Text format					
Font	Tahoma, 15px, style=Bold	Orientation	Horizontal	Horizontal alignment	Left
Vertical alignment	Middle	Line break	Disabled		
Flashing					
Flashing	Disabled				
		Flash on limit violation	Disabled		
Limits					
Color for High limit violated	237, 88, 97	Color for Low limit violated	241, 161, 44		
Styles/Designs					
Use style/design	Disabled				
		Style item appearance			
Miscellaneous					
Name	I/O field_11	Layer	0 - Layer_0	Tooltip	
Security					
Authorization		Allow operator control	Enabled	Two-hand operation	Disabled
Dynamizations\Tag connection					
Property name	Process value	Tag	HMI DATA_PumpFlow(liters/sec)_2		
I/O field_13					
Type	I/O field				

Instrumentation Tools

Totally Integrated Automation Portal					
General					
Process value	0	Mode	Input/output	Display format	Binary
Shift decimal point	0	Field length	1	Show leading zeros	Disabled
Format pattern	1				
Appearance					
Background color	255, 255, 255	Background fill pattern	Solid	Corner radius	3
Foreground color	49, 52, 74	Unit		Border width	4
Line style	Double line	Border color	71, 73, 87	Border background color	101, 103, 115
Characteristics					
Hidden input	Disabled				
Layout					
X position	765	Y position	532	Width	96
Height	32	Left margin	3	Top margin	2
Right margin	2	Bottom margin	2	Fit object to contents	Disabled
Text format					
Font	Tahoma, 15px, style=Bold	Orientation	Horizontal	Horizontal alignment	Left
Vertical alignment	Middle	Line break	Disabled		
Flashing					
Flashing	Disabled	Flash on limit violation	Disabled		
Limits					
Color for High limit violated	237, 88, 97	Color for Low limit violated	241, 161, 44		
Styles/Designs					
Use style/design	Disabled	Style item appearance			
Miscellaneous					
Name	I/O field_13	Layer	0 - Layer_0	Tooltip	
Security					
Authorization		Allow operator control	Enabled	Two-hand operation	Disabled
Dynamizations\Tag connection					
Property name	Process value	Tag	PID_Compact_2_Output_PWM		
Rectangle_1					
Type	Rectangle				
Appearance					
Background color	0, 122, 204	Background fill pattern	Solid	Border width	1
Line style	Solid	Border color	0, 122, 204		
Layout					
X position	1015	Y position	180	Width	17
Height	376	Round corner width	0	Round corner height	0
Flashing					
Flashing	Disabled				
Styles/Designs					
Use style/design	Disabled	Style item appearance			
Miscellaneous					
Name	Rectangle_1	Layer	0 - Layer_0		
Dynamizations\Visibility					
Tag - Cycle	HMI DATA_PLC_Output_2 -	Data type	Range	Start range	1
End range	1	Visibility	Visible		

PID_PWM and PID_Output / PC station [SIMATIC PC station] / HMI_RT_1 [WinCC RT Advanced] /
Screen management

Templates

This folder is empty.

PID_PWM and PID_Output / PC station [SIMATIC PC station] / HMI_RT_1 [WinCC RT Advanced] /
Screen management

Pop-up screens

This folder is empty.

Instrumentation Tools

Totally Integrated Automation Portal

PID_PWM and PID_Output / PC station [SIMATIC PC station] / HMI_RT_1 [WinCC RT Advanced] / Screen management / Slide-in screens

Slide-in screen bottom

Hardcopy of Slide-in screen bottom



General					
Name	Slide-in screen bottom	Background color	182, 182, 182	Grid color	0, 0, 0
Activate slide-in screen	Disabled				
Layout					
Width	1280	Height	267		
Layers					
Active layer	0				

Layer_0	Enabled
Layer_1	Enabled
Layer_2	Enabled
Layer_3	Enabled
Layer_4	Enabled
Layer_5	Enabled
Layer_6	Enabled
Layer_7	Enabled
Layer_8	Enabled
Layer_9	Enabled
Layer_10	Enabled
Layer_11	Enabled
Layer_12	Enabled
Layer_13	Enabled
Layer_14	Enabled
Layer_15	Enabled
Layer_16	Enabled
Layer_17	Enabled
Layer_18	Enabled
Layer_19	Enabled
Layer_20	Enabled
Layer_21	Enabled
Layer_22	Enabled
Layer_23	Enabled
Layer_24	Enabled
Layer_25	Enabled
Layer_26	Enabled
Layer_27	Enabled
Layer_28	Enabled
Layer_29	Enabled
Layer_30	Enabled
Layer_31	Enabled

Handle					
Line color	223, 223, 223	Alternative line color	32, 32, 32	Color of operable area	128, 128, 128
Visibility	Hide handle automatically				
Security					
Authorization		Operator control enabled	Enabled		

Instrumentation Tools

Totally Integrated Automation Portal

PID_PWM and PID_Output / PC station [SIMATIC PC station] / HMI_RT_1 [WinCC RT Advanced] / Screen management / Slide-in screens

Slide-in screen left

Hardcopy of Slide-in screen left

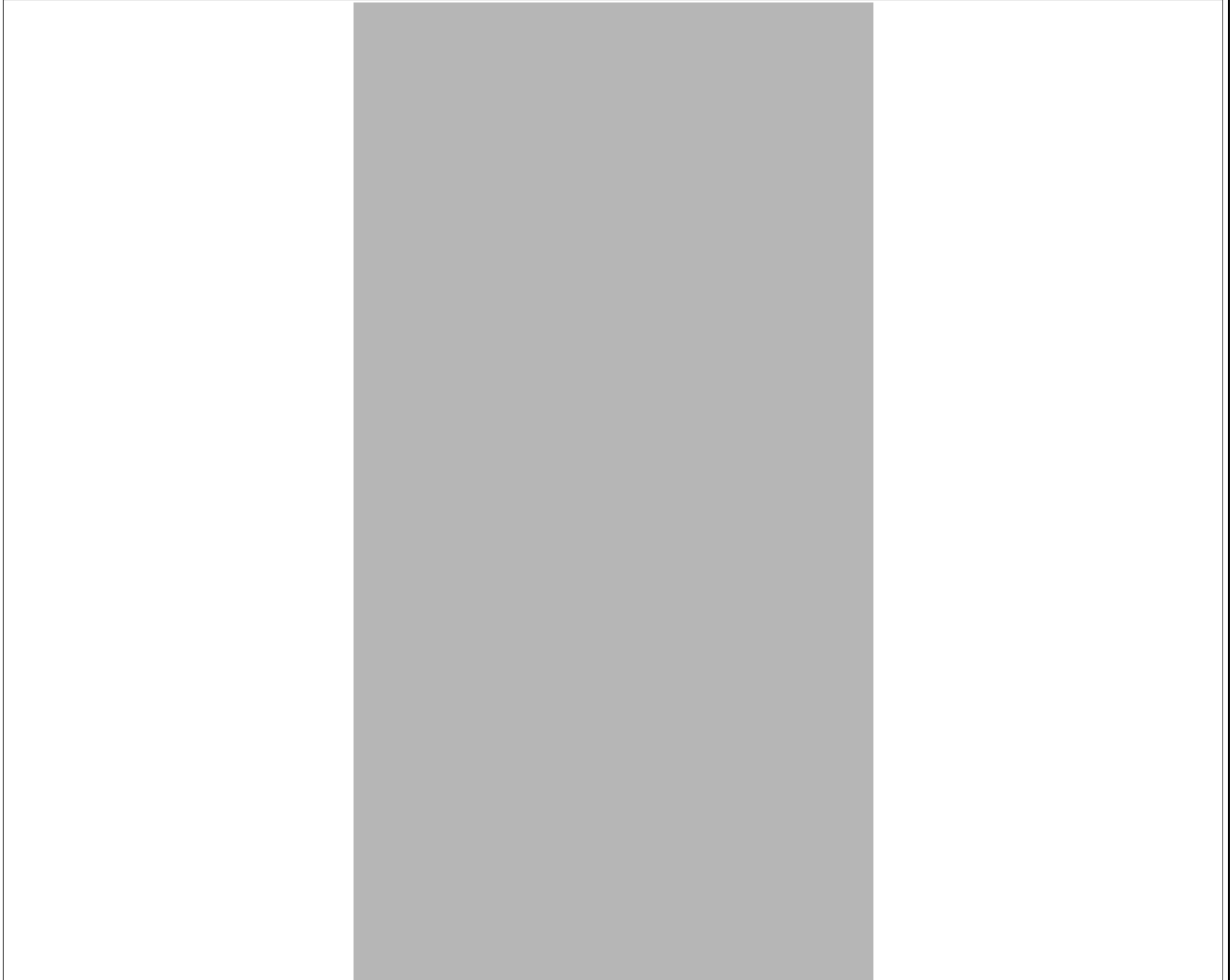

General					
Name	Slide-in screen left	Background color	182, 182, 182	Grid color	0, 0, 0
Activate slide-in screen	Disabled				
Layout					
Width	424	Height	800		
Layers					
Active layer	0				
Layer_0				Enabled	
Layer_1				Enabled	
Layer_2				Enabled	
Layer_3				Enabled	
Layer_4				Enabled	
Layer_5				Enabled	
Layer_6				Enabled	
Layer_7				Enabled	
Layer_8				Enabled	
Layer_9				Enabled	
Layer_10				Enabled	
Layer_11				Enabled	
Layer_12				Enabled	
Layer_13				Enabled	
Layer_14				Enabled	
Layer_15				Enabled	
Layer_16				Enabled	
Layer_17				Enabled	
Layer_18				Enabled	
Layer_19				Enabled	

Instrumentation Tools

Totally Integrated Automation Portal		
Layer_20		Enabled
Layer_21		Enabled
Layer_22		Enabled
Layer_23		Enabled
Layer_24		Enabled
Layer_25		Enabled
Layer_26		Enabled
Layer_27		Enabled
Layer_28		Enabled
Layer_29		Enabled
Layer_30		Enabled
Layer_31		Enabled
Handle		
Line color	223, 223, 223	Alternative line color 32, 32, 32
		Color of operable area 128, 128, 128
Visibility	Hide handle automatically	
Security		
Authorization		Operator control enabled Enabled

Instrumentation Tools

Totally Integrated Automation Portal

PID_PWM and PID_Output / PC station [SIMATIC PC station] / HMI_RT_1 [WinCC RT Advanced] / Screen management / Slide-in screens

Slide-in screen right

Hardcopy of Slide-in screen right

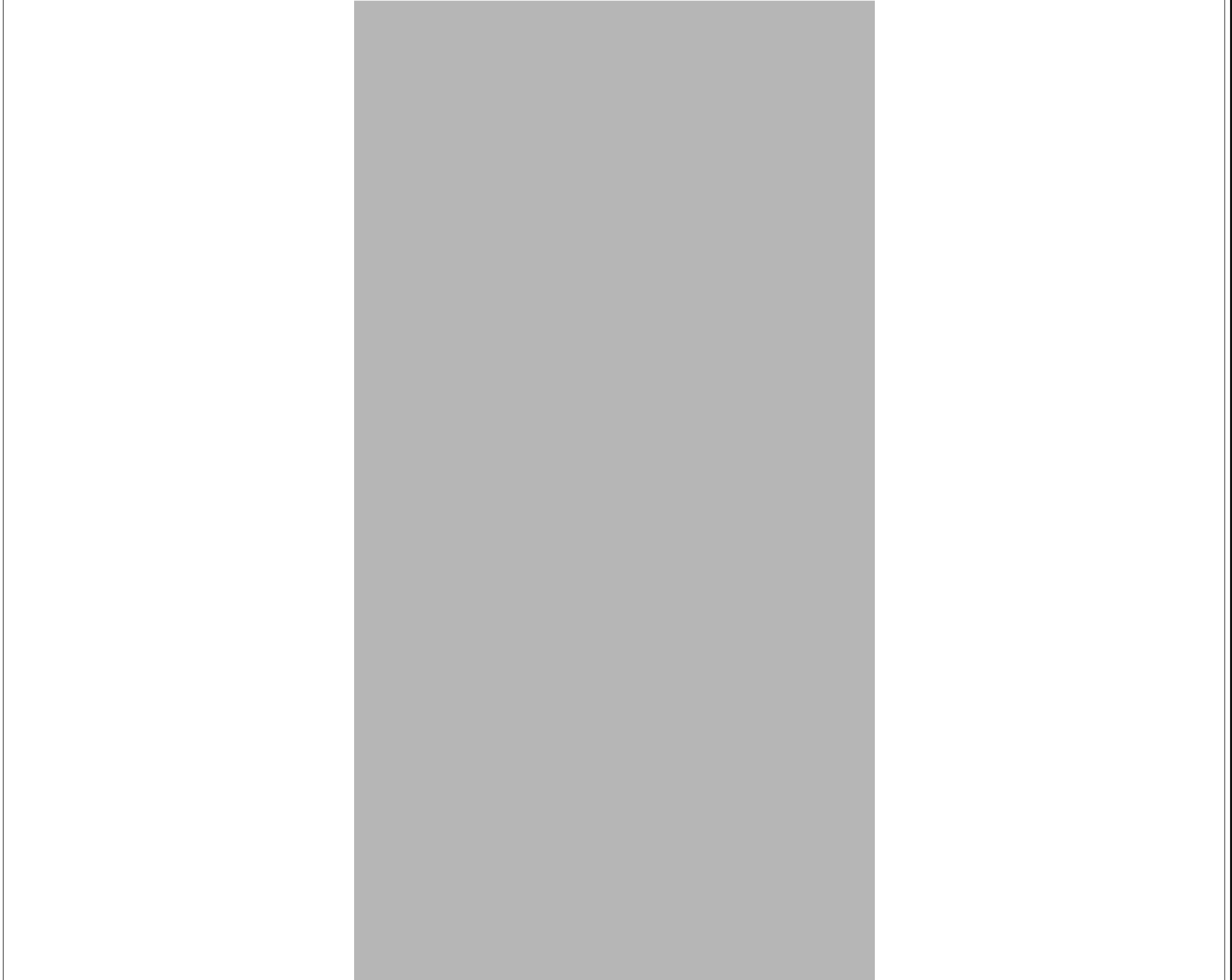

General					
Name	Slide-in screen right	Background color	182, 182, 182	Grid color	0, 0, 0
Activate slide-in screen	Disabled				
Layout					
Width	424	Height	800		
Layers					
Active layer	0				
Layer_0				Enabled	
Layer_1				Enabled	
Layer_2				Enabled	
Layer_3				Enabled	
Layer_4				Enabled	
Layer_5				Enabled	
Layer_6				Enabled	
Layer_7				Enabled	
Layer_8				Enabled	
Layer_9				Enabled	
Layer_10				Enabled	
Layer_11				Enabled	
Layer_12				Enabled	
Layer_13				Enabled	
Layer_14				Enabled	
Layer_15				Enabled	
Layer_16				Enabled	
Layer_17				Enabled	
Layer_18				Enabled	
Layer_19				Enabled	

Instrumentation Tools

Totally Integrated Automation Portal					
Layer_20				Enabled	
Layer_21				Enabled	
Layer_22				Enabled	
Layer_23				Enabled	
Layer_24				Enabled	
Layer_25				Enabled	
Layer_26				Enabled	
Layer_27				Enabled	
Layer_28				Enabled	
Layer_29				Enabled	
Layer_30				Enabled	
Layer_31				Enabled	
Handle					
Line color	223, 223, 223	Alternative line color	32, 32, 32	Color of operable area	128, 128, 128
Visibility	Hide handle automatically				
Security					
Authorization			Operator control enabled	Enabled	

Instrumentation Tools

Totally Integrated Automation Portal

PID_PWM and PID_Output / PC station [SIMATIC PC station] / HMI_RT_1 [WinCC RT Advanced] / Screen management / Slide-in screens

Slide-in screen top

Hardcopy of Slide-in screen top



General

Name	Slide-in screen top	Background color	182, 182, 182	Grid color	0, 0, 0
-------------	---------------------	-------------------------	---------------	-------------------	---------

Activate slide-in screen	Disabled
---------------------------------	----------

Layout

Width	1280	Height	267
--------------	------	---------------	-----

Layers

Active layer	0
---------------------	---

Layer_0	Enabled
Layer_1	Enabled
Layer_2	Enabled
Layer_3	Enabled
Layer_4	Enabled
Layer_5	Enabled
Layer_6	Enabled
Layer_7	Enabled
Layer_8	Enabled
Layer_9	Enabled
Layer_10	Enabled
Layer_11	Enabled
Layer_12	Enabled
Layer_13	Enabled
Layer_14	Enabled
Layer_15	Enabled
Layer_16	Enabled
Layer_17	Enabled
Layer_18	Enabled
Layer_19	Enabled
Layer_20	Enabled
Layer_21	Enabled
Layer_22	Enabled
Layer_23	Enabled
Layer_24	Enabled
Layer_25	Enabled
Layer_26	Enabled
Layer_27	Enabled
Layer_28	Enabled
Layer_29	Enabled
Layer_30	Enabled
Layer_31	Enabled

Handle

Line color	223, 223, 223	Alternative line color	32, 32, 32	Color of operable area	128, 128, 128
-------------------	---------------	-------------------------------	------------	-------------------------------	---------------

Visibility	Hide handle automatically
-------------------	---------------------------

Security

Authorization		Operator control enabled	Enabled
----------------------	--	---------------------------------	---------

Instrumentation Tools

Totally Integrated
Automation Portal

PID_PWM and PID_Output / PC station [SIMATIC PC station] / HMI_RT_1 [WinCC RT Advanced] /
Screen management

Global screen

Hardcopy of Global screen



General

Name	Global screen	Background color	182, 182, 182	Grid color	0, 0, 0
-------------	---------------	-------------------------	---------------	-------------------	---------

PID_PWM and PID_Output / PC station [SIMATIC PC station] / HMI_RT_1 [WinCC RT Advanced] / Screen management

Permanent area

General					
Name	Permanent area	Background color	182, 182, 182	Grid color	0, 0, 0
Height	0				

Layers	
Active layer	0

Layer_0	Enabled
Layer_1	Enabled
Layer_2	Enabled
Layer_3	Enabled
Layer_4	Enabled
Layer_5	Enabled
Layer_6	Enabled
Layer_7	Enabled
Layer_8	Enabled
Layer_9	Enabled
Layer_10	Enabled
Layer_11	Enabled
Layer_12	Enabled
Layer_13	Enabled
Layer_14	Enabled
Layer_15	Enabled
Layer_16	Enabled
Layer_17	Enabled
Layer_18	Enabled
Layer_19	Enabled
Layer_20	Enabled
Layer_21	Enabled
Layer_22	Enabled
Layer_23	Enabled
Layer_24	Enabled
Layer_25	Enabled
Layer_26	Enabled
Layer_27	Enabled
Layer_28	Enabled
Layer_29	Enabled
Layer_30	Enabled
Layer_31	Enabled

Instrumentation Tools

Totally Integrated Automation Portal		
--------------------------------------	--	--

PID_PWM and PID_Output / PC station [SIMATIC PC station] / HMI_RT_1 [WinCC RT Advanced] / HMI tags

Default tag table [36]

HMI DATA_FillLevel(in liters)

General					
Name	HMI DATA_FillLevel(in liters)	Display name		Connection	HMI_Connection_1
Data type	Real	Array elements	0	Length	4
Address		Access mode	<symbolic access>	PLC tag	"HMI DATA".FillLevel(in liters)"
Coding	IEEE754	PLC name	PLC_1		
Settings					
Acquisition cycle	1 s	Acquisition mode	Cyclic in operation		
Limits					
Upper 2		Upper 1		Lower 1	
Lower 2					
Linear scaling					
Linear scaling	Disabled	PLC value range end value	10	PLC value range start value	0
HMI device value range end value	100	HMI device value range start value	0		
Values					
ID tag		Start value			
Comment					
Comment		Source comment			
Multiplexing					
Multiplexing	Disabled	Index tag			
Logging					
Data log					
GMP (Good Manufacturing Practice)					
Confirmation type	None	GMP relevant	Disabled	Comment required	Disabled

HMI DATA_PumpFlow(liters/sec)

General					
Name	HMI DATA_PumpFlow(liters/sec)	Display name		Connection	HMI_Connection_1
Data type	Real	Array elements	0	Length	4
Address		Access mode	<symbolic access>	PLC tag	"HMI DATA".PumpFlow(liters/sec)
Coding	IEEE754	PLC name	PLC_1		
Settings					
Acquisition cycle	1 s	Acquisition mode	Cyclic in operation		
Limits					
Upper 2		Upper 1		Lower 1	
Lower 2					
Linear scaling					
Linear scaling	Disabled	PLC value range end value	10	PLC value range start value	0
HMI device value range end value	100	HMI device value range start value	0		
Values					
ID tag		Start value			
Comment					
Comment		Source comment			
Multiplexing					
Multiplexing	Disabled	Index tag			
Logging					
Data log					
GMP (Good Manufacturing Practice)					
Confirmation type	None	GMP relevant	Disabled	Comment required	Disabled

HMI DATA_PLC_Output

General					
Name	HMI DATA_PLC_Output	Display name		Connection	HMI_Connection_1
Data type	Int	Array elements	0	Length	2
Address		Access mode	<symbolic access>	PLC tag	"HMI DATA".PLC_Output
Coding	Binary	PLC name	PLC_1		
Settings					
Acquisition cycle	1 s	Acquisition mode	Cyclic in operation		
Limits					
Upper 2		Upper 1		Lower 1	
Lower 2					
Linear scaling					
Linear scaling	Disabled	PLC value range end value	10	PLC value range start value	0
HMI device value range end value	100	HMI device value range start value	0		
Values					
ID tag		Start value			
Comment					
Comment		Source comment			
Multiplexing					
Multiplexing	Disabled	Index tag			
Logging					
Data log					
GMP (Good Manufacturing Practice)					
Confirmation type	None	GMP relevant	Disabled	Comment required	Disabled

Instrumentation Tools

Totally Integrated Automation Portal		
--------------------------------------	--	--

HMI DATA_Setpoint(in liters)

General					
Name	HMI DATA_Setpoint(in liters)	Display name		Connection	HMI_Connection_1
Data type	Real	Array elements	0	Length	4
Address		Access mode	<symbolic access>	PLC tag	"HMI DATA"."Setpoint(in liters)"
Coding	IEEE754	PLC name	PLC_1		
Settings					
Acquisition cycle	1 s	Acquisition mode	Cyclic in operation		
Limits					
Upper 2		Upper 1		Lower 1	
Lower 2					
Linear scaling					
Linear scaling	Disabled	PLC value range end value	10	PLC value range start value	0
HMI device value range end value	100	HMI device value range start value	0		
Values					
ID tag		Start value			
Comment					
Comment		Source comment			
Multiplexing					
Multiplexing	Disabled	Index tag			
Logging					
Data log					
GMP (Good Manufacturing Practice)					
Confirmation type	None	GMP relevant	Disabled	Comment required	Disabled

HMI DATA_Tolerance(in liters)

General					
Name	HMI DATA_Tolerance(in liters)	Display name		Connection	HMI_Connection_1
Data type	Real	Array elements	0	Length	4
Address		Access mode	<symbolic access>	PLC tag	"HMI DATA"."Tolerance(in liters)"
Coding	IEEE754	PLC name	PLC_1		
Settings					
Acquisition cycle	1 s	Acquisition mode	Cyclic in operation		
Limits					
Upper 2		Upper 1		Lower 1	
Lower 2					
Linear scaling					
Linear scaling	Disabled	PLC value range end value	10	PLC value range start value	0
HMI device value range end value	100	HMI device value range start value	0		
Values					
ID tag		Start value			
Comment					
Comment		Source comment			
Multiplexing					
Multiplexing	Disabled	Index tag			
Logging					
Data log					
GMP (Good Manufacturing Practice)					
Confirmation type	None	GMP relevant	Disabled	Comment required	Disabled

HMI DATA_RandomNoise

General					
Name	HMI DATA_RandomNoise	Display name		Connection	HMI_Connection_1
Data type	Int	Array elements	0	Length	2
Address		Access mode	<symbolic access>	PLC tag	"HMI DATA".RandomNoise
Coding	Binary	PLC name	PLC_1		
Settings					
Acquisition cycle	1 s	Acquisition mode	Cyclic in operation		
Limits					
Upper 2		Upper 1		Lower 1	
Lower 2					
Linear scaling					
Linear scaling	Disabled	PLC value range end value	10	PLC value range start value	0
HMI device value range end value	100	HMI device value range start value	0		
Values					
ID tag		Start value			
Comment					
Comment		Source comment			
Multiplexing					
Multiplexing	Disabled	Index tag			
Logging					
Data log					
GMP (Good Manufacturing Practice)					
Confirmation type	None	GMP relevant	Disabled	Comment required	Disabled

HMI DATA_Disturbance flow (%/sec)

General					
Name	HMI DATA_Disturbance flow (%/sec)	Display name		Connection	HMI_Connection_1
Data type	Real	Array elements	0	Length	4

Instrumentation Tools

Totally Integrated Automation Portal					
Address		Access mode		PLC tag	
IEEE754		<symbolic access>		"HMI DATA"."Disturbance flow (%/sec)"	
Coding		PLC name			
1 s		PLC_1			
Settings					
Acquisition cycle		Acquisition mode			
1 s		Cyclic in operation			
Limits					
Upper 2		Upper 1		Lower 1	
Lower 2					
Linear scaling					
Linear scaling		PLC value range end value		PLC value range start value	
Disabled		10		0	
HMI device value range end value		HMI device value range start value			
100		0			
Values					
ID tag		Start value			
Comment					
Comment		Source comment			
Multiplexing					
Multiplexing		Index tag			
Disabled					
Logging					
Data log					
GMP (Good Manufacturing Practice)					
Confirmation type		GMP relevant		Comment required	
None		Disabled		Disabled	
HMI DATA_IdleTime(ms)					
General					
Name		Display name		Connection	
HMI DATA_IdleTime(ms)				HMI_Connection_1	
Data type		Array elements		Length	
Int		0		2	
Address		Access mode		PLC tag	
		<symbolic access>		"HMI DATA".IdleTime(ms)	
Coding		PLC name			
Binary		PLC_1			
Settings					
Acquisition cycle		Acquisition mode			
1 s		Cyclic in operation			
Limits					
Upper 2		Upper 1		Lower 1	
Lower 2					
Linear scaling					
Linear scaling		PLC value range end value		PLC value range start value	
Disabled		10		0	
HMI device value range end value		HMI device value range start value			
100		0			
Values					
ID tag		Start value			
Comment					
Comment		Source comment			
Multiplexing					
Multiplexing		Index tag			
Disabled					
Logging					
Data log					
GMP (Good Manufacturing Practice)					
Confirmation type		GMP relevant		Comment required	
None		Disabled		Disabled	
HMI DATA_EmptyTank					
General					
Name		Display name		Connection	
HMI DATA_EmptyTank				HMI_Connection_1	
Data type		Array elements		Length	
Bool		0		1	
Address		Access mode		PLC tag	
		<symbolic access>		"HMI DATA".EmptyTank	
Coding		PLC name			
Binary		PLC_1			
Settings					
Acquisition cycle		Acquisition mode			
1 s		Cyclic in operation			
Limits					
Upper 2		Upper 1		Lower 1	
Lower 2					
Linear scaling					
Linear scaling		PLC value range end value		PLC value range start value	
Disabled		10		0	
HMI device value range end value		HMI device value range start value			
100		0			
Values					
ID tag		Start value			
Comment					
Comment		Source comment			
Multiplexing					
Multiplexing		Index tag			
Disabled					
Logging					
Data log					
GMP (Good Manufacturing Practice)					
Confirmation type		GMP relevant		Comment required	
None		Disabled		Disabled	
PID_Compact_1_CtrlParamsBackUp_Gain					
General					
Name		Display name		Connection	
PID_Compact_1_CtrlParamsBack-Up_Gain				HMI_Connection_1	
Data type		Array elements		Length	
Real		0		4	
Address		Access mode		PLC tag	
		<symbolic access>		PID_Compact_1.CtrlParamsBack-Up.Gain	
Coding		PLC name			
IEEE754		PLC_1			

Instrumentation Tools

Totally Integrated Automation Portal					
Settings					
Acquisition cycle	1 s	Acquisition mode	Cyclic in operation		
Limits					
Upper 2		Upper 1		Lower 1	
Lower 2					
Linear scaling					
Linear scaling	Disabled	PLC value range end value	10	PLC value range start value	0
HMI device value range end value	100	HMI device value range start value	0		
Values					
ID tag		Start value			
Comment					
Comment		Source comment	proportional gain		
Multiplexing					
Multiplexing	Disabled	Index tag			
Logging					
Data log					
GMP (Good Manufacturing Practice)					
Confirmation type	None	GMP relevant	Disabled	Comment required	Disabled
PID_Compact_1_CtrlParamsBackUp_Ti					
General					
Name	PID_Compact_1_CtrlParamsBackUp_Ti	Display name		Connection	HMI_Connection_1
Data type	Real	Array elements	0	Length	4
Address		Access mode	<symbolic access>	PLC tag	PID_Compact_1.CtrlParamsBackUp.Ti
Coding	IEEE754	PLC name	PLC_1		
Settings					
Acquisition cycle	1 s	Acquisition mode	Cyclic in operation		
Limits					
Upper 2		Upper 1		Lower 1	
Lower 2					
Linear scaling					
Linear scaling	Disabled	PLC value range end value	10	PLC value range start value	0
HMI device value range end value	100	HMI device value range start value	0		
Values					
ID tag		Start value			
Comment					
Comment		Source comment	reset time		
Multiplexing					
Multiplexing	Disabled	Index tag			
Logging					
Data log					
GMP (Good Manufacturing Practice)					
Confirmation type	None	GMP relevant	Disabled	Comment required	Disabled
PID_Compact_1_CtrlParamsBackUp_Td					
General					
Name	PID_Compact_1_CtrlParamsBackUp_Td	Display name		Connection	HMI_Connection_1
Data type	Real	Array elements	0	Length	4
Address		Access mode	<symbolic access>	PLC tag	PID_Compact_1.CtrlParamsBackUp.Td
Coding	IEEE754	PLC name	PLC_1		
Settings					
Acquisition cycle	1 s	Acquisition mode	Cyclic in operation		
Limits					
Upper 2		Upper 1		Lower 1	
Lower 2					
Linear scaling					
Linear scaling	Disabled	PLC value range end value	10	PLC value range start value	0
HMI device value range end value	100	HMI device value range start value	0		
Values					
ID tag		Start value			
Comment					
Comment		Source comment	derivative time		
Multiplexing					
Multiplexing	Disabled	Index tag			
Logging					
Data log					
GMP (Good Manufacturing Practice)					
Confirmation type	None	GMP relevant	Disabled	Comment required	Disabled
PID_Compact_1_Retain_CtrlParams_Gain					
General					
Name	PID_Compact_1_Retain_CtrlParams_Gain	Display name		Connection	HMI_Connection_1
Data type	Real	Array elements	0	Length	4
Address		Access mode	<symbolic access>	PLC tag	PID_Compact_1.Retain.CtrlParams.Gain
Coding	IEEE754	PLC name	PLC_1		
Settings					
Acquisition cycle	1 s	Acquisition mode	Cyclic in operation		

Instrumentation Tools

Totally Integrated Automation Portal		
--------------------------------------	--	--

Limits					
Upper 2		Upper 1		Lower 1	
Lower 2					
Linear scaling					
Linear scaling	Disabled	PLC value range end value	10	PLC value range start value	0
HMI device value range end value	100	HMI device value range start value	0		
Values					
ID tag		Start value			
Comment					
Comment		Source comment	proportional gain		
Multiplexing					
Multiplexing	Disabled	Index tag			
Logging					
Data log					
GMP (Good Manufacturing Practice)					
Confirmation type	None	GMP relevant	Disabled	Comment required	Disabled

PID_Compact_1_Retain_CtrlParams_Ti					
General					
Name	PID_Compact_1_Retain_CtrlParams_Ti	Display name		Connection	HMI_Connection_1
Data type	Real	Array elements	0	Length	4
Address		Access mode	<symbolic access>	PLC tag	PID_Compact_1.Retain.CtrlParams.Ti
Coding	IIEEE754	PLC name	PLC_1		
Settings					
Acquisition cycle	1 s	Acquisition mode	Cyclic in operation		
Limits					
Upper 2		Upper 1		Lower 1	
Lower 2					
Linear scaling					
Linear scaling	Disabled	PLC value range end value	10	PLC value range start value	0
HMI device value range end value	100	HMI device value range start value	0		
Values					
ID tag		Start value			
Comment					
Comment		Source comment	reset time		
Multiplexing					
Multiplexing	Disabled	Index tag			
Logging					
Data log					
GMP (Good Manufacturing Practice)					
Confirmation type	None	GMP relevant	Disabled	Comment required	Disabled

PID_Compact_1_Retain_CtrlParams_Td					
General					
Name	PID_Compact_1_Retain_CtrlParams_Td	Display name		Connection	HMI_Connection_1
Data type	Real	Array elements	0	Length	4
Address		Access mode	<symbolic access>	PLC tag	PID_Compact_1.Retain.CtrlParams.Td
Coding	IIEEE754	PLC name	PLC_1		
Settings					
Acquisition cycle	1 s	Acquisition mode	Cyclic in operation		
Limits					
Upper 2		Upper 1		Lower 1	
Lower 2					
Linear scaling					
Linear scaling	Disabled	PLC value range end value	10	PLC value range start value	0
HMI device value range end value	100	HMI device value range start value	0		
Values					
ID tag		Start value			
Comment					
Comment		Source comment	derivative time		
Multiplexing					
Multiplexing	Disabled	Index tag			
Logging					
Data log					
GMP (Good Manufacturing Practice)					
Confirmation type	None	GMP relevant	Disabled	Comment required	Disabled

PID_Compact_1_Output_PER					
General					
Name	PID_Compact_1_Output_PER	Display name		Connection	HMI_Connection_1
Data type	Int	Array elements	0	Length	2
Address		Access mode	<symbolic access>	PLC tag	PID_Compact_1.Output_PER
Coding	Binary	PLC name	PLC_1		
Settings					
Acquisition cycle	1 s	Acquisition mode	Cyclic in operation		
Limits					
Upper 2		Upper 1		Lower 1	
Lower 2					

--	--	--

Instrumentation Tools

Totally Integrated Automation Portal					
Linear scaling					
Linear scaling	Disabled	PLC value range end value	10	PLC value range start value	0
HMI device value range end value	100	HMI device value range start value	0		
Values					
ID tag		Start value			
Comment					
Comment		Source comment	analog output value		
Multiplexing					
Multiplexing	Disabled	Index tag			
Logging					
Data log					
GMP (Good Manufacturing Practice)					
Confirmation type	None	GMP relevant	Disabled	Comment required	Disabled
PID_Compact_1_Output					
General					
Name	PID_Compact_1_Output	Display name		Connection	HMI_Connection_1
Data type	Real	Array elements	0	Length	4
Address		Access mode	<symbolic access>	PLC tag	PID_Compact_1.Output
Coding	IEEE754	PLC name	PLC_1		
Settings					
Acquisition cycle	1 s	Acquisition mode	Cyclic in operation		
Limits					
Upper 2		Upper 1		Lower 1	
Lower 2					
Linear scaling					
Linear scaling	Disabled	PLC value range end value	10	PLC value range start value	0
HMI device value range end value	100	HMI device value range start value	0		
Values					
ID tag		Start value			
Comment					
Comment		Source comment	output value in REAL format		
Multiplexing					
Multiplexing	Disabled	Index tag			
Logging					
Data log					
GMP (Good Manufacturing Practice)					
Confirmation type	None	GMP relevant	Disabled	Comment required	Disabled
PID_Compact_1_Error					
General					
Name	PID_Compact_1_Error	Display name		Connection	HMI_Connection_1
Data type	Bool	Array elements	0	Length	1
Address		Access mode	<symbolic access>	PLC tag	PID_Compact_1.Error
Coding	Binary	PLC name	PLC_1		
Settings					
Acquisition cycle	1 s	Acquisition mode	Cyclic in operation		
Limits					
Upper 2		Upper 1		Lower 1	
Lower 2					
Linear scaling					
Linear scaling	Disabled	PLC value range end value	10	PLC value range start value	0
HMI device value range end value	100	HMI device value range start value	0		
Values					
ID tag		Start value			
Comment					
Comment		Source comment	error flag		
Multiplexing					
Multiplexing	Disabled	Index tag			
Logging					
Data log					
GMP (Good Manufacturing Practice)					
Confirmation type	None	GMP relevant	Disabled	Comment required	Disabled
PID_Compact_1_PIDCtrl					
General					
Name	PID_Compact_1_PIDCtrl	Display name		Connection	HMI_Connection_1
Array elements	0	Length	60	Address	
Access mode	<symbolic access>	PLC tag	PID_Compact_1.PIDCtrl	Coding	Binary
PLC name	PLC_1				
Settings					
Acquisition cycle	1 s	Acquisition mode	Cyclic in operation		
Limits					
Upper 2		Upper 1		Lower 1	
Lower 2					
Linear scaling					
Linear scaling	Disabled	PLC value range end value	10	PLC value range start value	0
HMI device value range end value	100	HMI device value range start value	0		

Instrumentation Tools

Totally Integrated Automation Portal		
--------------------------------------	--	--

Values					
ID tag		Start value			
Comment					
Comment		Source comment	data for controlling part		
Multiplexing					
Multiplexing	Disabled	Index tag			
Logging					
Data log					
GMP (Good Manufacturing Practice)					
Confirmation type	None	GMP relevant	Disabled	Comment required	Disabled

PID_Compact_1_PIDCtrl_PIDInit

General					
Name	PID_Compact_1_PIDCtrl_PIDInit	Display name		Connection	HMI_Connection_1
Data type	Bool	Array elements	0	Length	1
Address		Access mode	<symbolic access>	PLC tag	PID_Compact_1.PIDCtrl.PIDInit
Coding	Binary	PLC name	PLC_1		
Settings					
Acquisition cycle	1 s	Acquisition mode	Cyclic in operation		
Limits					
Upper 2		Upper 1		Lower 1	
Lower 2					
Linear scaling					
Linear scaling	Disabled	PLC value range end value	10	PLC value range start value	0
HMI device value range end value	100	HMI device value range start value	0		
Values					
ID tag		Start value			
Comment					
Comment		Source comment	initialization of controller		
Multiplexing					
Multiplexing	Disabled	Index tag			
Logging					
Data log					
GMP (Good Manufacturing Practice)					
Confirmation type	None	GMP relevant	Disabled	Comment required	Disabled

PID_Compact_1_Config_SetpointLowerLimit

General					
Name	PID_Compact_1_Config_SetpointLowerLimit	Display name		Connection	HMI_Connection_1
Data type	Real	Array elements	0	Length	4
Address		Access mode	<symbolic access>	PLC tag	PID_Compact_1.Config.SetpointLowerLimit
Coding	IEEE754	PLC name	PLC_1		
Settings					
Acquisition cycle	1 s	Acquisition mode	Cyclic in operation		
Limits					
Upper 2		Upper 1		Lower 1	
Lower 2					
Linear scaling					
Linear scaling	Disabled	PLC value range end value	10	PLC value range start value	0
HMI device value range end value	100	HMI device value range start value	0		
Values					
ID tag		Start value			
Comment					
Comment		Source comment	setpoint lower limit value		
Multiplexing					
Multiplexing	Disabled	Index tag			
Logging					
Data log					
GMP (Good Manufacturing Practice)					
Confirmation type	None	GMP relevant	Disabled	Comment required	Disabled

Analog Data_TankLevelPLC_input

General					
Name	Analog Data_TankLevelPLC_input	Display name		Connection	HMI_Connection_1
Data type	Int	Array elements	0	Length	2
Address		Access mode	<symbolic access>	PLC tag	"Analog Data".Tank1LevelPLC_input
Coding	Binary	PLC name	PLC_1		
Settings					
Acquisition cycle	1 s	Acquisition mode	Cyclic in operation		
Limits					
Upper 2		Upper 1		Lower 1	
Lower 2					
Linear scaling					
Linear scaling	Disabled	PLC value range end value	10	PLC value range start value	0
HMI device value range end value	100	HMI device value range start value	0		
Values					
ID tag		Start value			

Instrumentation Tools

Totally Integrated Automation Portal					
Comment					
Comment		Source comment			
Multiplexing					
Multiplexing	Disabled	Index tag			
Logging					
Data log					
GMP (Good Manufacturing Practice)					
Confirmation type	None	GMP relevant	Disabled	Comment required	Disabled
HMI DATA_SystemNoise					
General					
Name	HMI DATA_SystemNoise	Display name		Connection	HMI_Connection_1
Data type	Real	Array elements	0	Length	4
Address		Access mode	<symbolic access>	PLC tag	"HMI DATA".SystemNoise
Coding	IEEE754	PLC name	PLC_1		
Settings					
Acquisition cycle	1 s	Acquisition mode	Cyclic in operation		
Limits					
Upper 2		Upper 1		Lower 1	
Lower 2					
Linear scaling					
Linear scaling	Disabled	PLC value range end value	10	PLC value range start value	0
HMI device value range end value	100	HMI device value range start value	0		
Values					
ID tag		Start value			
Comment					
Comment		Source comment			
Multiplexing					
Multiplexing	Disabled	Index tag			
Logging					
Data log					
GMP (Good Manufacturing Practice)					
Confirmation type	None	GMP relevant	Disabled	Comment required	Disabled
PID_Compact_2_Retain_CtrlParams_Gain					
General					
Name	PID_Compact_2_Retain_CtrlParams_Gain	Display name		Connection	HMI_Connection_1
Data type	Real	Array elements	0	Length	4
Address		Access mode	<symbolic access>	PLC tag	PID_Compact_2.Retain.CtrlParams.Gain
Coding	IEEE754	PLC name	PLC_1		
Settings					
Acquisition cycle	1 s	Acquisition mode	Cyclic in operation		
Limits					
Upper 2		Upper 1		Lower 1	
Lower 2					
Linear scaling					
Linear scaling	Disabled	PLC value range end value	10	PLC value range start value	0
HMI device value range end value	100	HMI device value range start value	0		
Values					
ID tag		Start value			
Comment					
Comment		Source comment	proportional gain		
Multiplexing					
Multiplexing	Disabled	Index tag			
Logging					
Data log					
GMP (Good Manufacturing Practice)					
Confirmation type	None	GMP relevant	Disabled	Comment required	Disabled
PID_Compact_2_Retain_CtrlParams_Ti					
General					
Name	PID_Compact_2_Retain_CtrlParams_Ti	Display name		Connection	HMI_Connection_1
Data type	Real	Array elements	0	Length	4
Address		Access mode	<symbolic access>	PLC tag	PID_Compact_2.Retain.CtrlParams.Ti
Coding	IEEE754	PLC name	PLC_1		
Settings					
Acquisition cycle	1 s	Acquisition mode	Cyclic in operation		
Limits					
Upper 2		Upper 1		Lower 1	
Lower 2					
Linear scaling					
Linear scaling	Disabled	PLC value range end value	10	PLC value range start value	0
HMI device value range end value	100	HMI device value range start value	0		
Values					
ID tag		Start value			
Comment					
Comment		Source comment	reset time		

Instrumentation Tools

Totally Integrated Automation Portal					
Multiplexing					
Multiplexing	Disabled	Index tag			
Logging					
Data log					
GMP (Good Manufacturing Practice)					
Confirmation type	None	GMP relevant	Disabled	Comment required	Disabled
PID_Compact_2_Retain_CtrlParams_Td					
General					
Name	PID_Compact_2_Retain_CtrlParams_Td	Display name		Connection	HMI_Connection_1
Data type	Real	Array elements	0	Length	4
Address		Access mode	<symbolic access>	PLC tag	PID_Compact_2.Retain.CtrlParams.Td
Coding	IEEE754	PLC name	PLC_1		
Settings					
Acquisition cycle	1 s	Acquisition mode	Cyclic in operation		
Limits					
Upper 2		Upper 1		Lower 1	
Lower 2					
Linear scaling					
Linear scaling	Disabled	PLC value range end value	10	PLC value range start value	0
HMI device value range end value	100	HMI device value range start value	0		
Values					
ID tag		Start value			
Comment					
Comment		Source comment	derivative time		
Multiplexing					
Multiplexing	Disabled	Index tag			
Logging					
Data log					
GMP (Good Manufacturing Practice)					
Confirmation type	None	GMP relevant	Disabled	Comment required	Disabled
HMI DATA_Disturbance flow (%/sec)_2					
General					
Name	HMI DATA_Disturbance flow (%/sec)_2	Display name		Connection	HMI_Connection_1
Data type	Real	Array elements	0	Length	4
Address		Access mode	<symbolic access>	PLC tag	"HMI DATA"."Disturbance flow (%/sec)_2"
Coding	IEEE754	PLC name	PLC_1		
Settings					
Acquisition cycle	1 s	Acquisition mode	Cyclic in operation		
Limits					
Upper 2		Upper 1		Lower 1	
Lower 2					
Linear scaling					
Linear scaling	Disabled	PLC value range end value	10	PLC value range start value	0
HMI device value range end value	100	HMI device value range start value	0		
Values					
ID tag		Start value			
Comment					
Comment		Source comment			
Multiplexing					
Multiplexing	Disabled	Index tag			
Logging					
Data log					
GMP (Good Manufacturing Practice)					
Confirmation type	None	GMP relevant	Disabled	Comment required	Disabled
HMI DATA_IdleTime(ms)_2					
General					
Name	HMI DATA_IdleTime(ms)_2	Display name		Connection	HMI_Connection_1
Data type	Int	Array elements	0	Length	2
Address		Access mode	<symbolic access>	PLC tag	"HMI DATA".IdleTime(ms)_2
Coding	Binary	PLC name	PLC_1		
Settings					
Acquisition cycle	1 s	Acquisition mode	Cyclic in operation		
Limits					
Upper 2		Upper 1		Lower 1	
Lower 2					
Linear scaling					
Linear scaling	Disabled	PLC value range end value	10	PLC value range start value	0
HMI device value range end value	100	HMI device value range start value	0		
Values					
ID tag		Start value			
Comment					
Comment		Source comment			
Multiplexing					
Multiplexing	Disabled	Index tag			

Instrumentation Tools

Totally Integrated Automation Portal					
Logging					
Data log					
GMP (Good Manufacturing Practice)					
Confirmation type	None	GMP relevant	Disabled	Comment required	Disabled
HMI DATA_PumpFlow(liters/sec)_2					
General					
Name	HMI DATA_PumpFlow(liters/sec)_2	Display name		Connection	HMI_Connection_1
Data type	Real	Array elements	0	Length	4
Address		Access mode	<symbolic access>	PLC tag	"HMI DATA".PumpFlow(liters/sec)_2
Coding	IEEE754	PLC name	PLC_1		
Settings					
Acquisition cycle	1 s	Acquisition mode	Cyclic in operation		
Limits					
Upper 2		Upper 1		Lower 1	
Lower 2					
Linear scaling					
Linear scaling	Disabled	PLC value range end value	10	PLC value range start value	0
HMI device value range end value	100	HMI device value range start value	0		
Values					
ID tag		Start value			
Comment					
Comment		Source comment			
Multiplexing					
Multiplexing	Disabled	Index tag			
Logging					
Data log					
GMP (Good Manufacturing Practice)					
Confirmation type	None	GMP relevant	Disabled	Comment required	Disabled
PID_Compact_2_Output_PWM					
General					
Name	PID_Compact_2_Output_PWM	Display name		Connection	HMI_Connection_1
Data type	Bool	Array elements	0	Length	1
Address		Access mode	<symbolic access>	PLC tag	PID_Compact_2.Output_PWM
Coding	Binary	PLC name	PLC_1		
Settings					
Acquisition cycle	1 s	Acquisition mode	Cyclic in operation		
Limits					
Upper 2		Upper 1		Lower 1	
Lower 2					
Linear scaling					
Linear scaling	Disabled	PLC value range end value	10	PLC value range start value	0
HMI device value range end value	100	HMI device value range start value	0		
Values					
ID tag		Start value			
Comment					
Comment		Source comment	pulse width modulated output value		
Multiplexing					
Multiplexing	Disabled	Index tag			
Logging					
Data log					
GMP (Good Manufacturing Practice)					
Confirmation type	None	GMP relevant	Disabled	Comment required	Disabled
HMI DATA_RandomNoise_2					
General					
Name	HMI DATA_RandomNoise_2	Display name		Connection	HMI_Connection_1
Data type	Int	Array elements	0	Length	2
Address		Access mode	<symbolic access>	PLC tag	"HMI DATA".RandomNoise_2
Coding	Binary	PLC name	PLC_1		
Settings					
Acquisition cycle	1 s	Acquisition mode	Cyclic in operation		
Limits					
Upper 2		Upper 1		Lower 1	
Lower 2					
Linear scaling					
Linear scaling	Disabled	PLC value range end value	10	PLC value range start value	0
HMI device value range end value	100	HMI device value range start value	0		
Values					
ID tag		Start value			
Comment					
Comment		Source comment			
Multiplexing					
Multiplexing	Disabled	Index tag			
Logging					
Data log					
GMP (Good Manufacturing Practice)					
Confirmation type	None	GMP relevant	Disabled	Comment required	Disabled

Instrumentation Tools

Totally Integrated Automation Portal		
--------------------------------------	--	--

HMI DATA_PLC_Output_2

General					
Name	HMI DATA_PLC_Output_2	Display name		Connection	HMI_Connection_1
Data type	Bool	Array elements	0	Length	1
Address		Access mode	<symbolic access>	PLC tag	"HMI DATA".PLC_Output_2
Coding	Binary	PLC name	PLC_1		
Settings					
Acquisition cycle	1 s	Acquisition mode	Cyclic in operation		
Limits					
Upper 2		Upper 1		Lower 1	
Lower 2					
Linear scaling					
Linear scaling	Disabled	PLC value range end value	10	PLC value range start value	0
HMI device value range end value	100	HMI device value range start value	0		
Values					
ID tag		Start value			
Comment					
Comment		Source comment			
Multiplexing					
Multiplexing	Disabled	Index tag			
Logging					
Data log					
GMP (Good Manufacturing Practice)					
Confirmation type	None	GMP relevant	Disabled	Comment required	Disabled

HMI DATA_FillLevel(in liters)_2

General					
Name	HMI DATA_FillLevel(in liters)_2	Display name		Connection	HMI_Connection_1
Data type	Real	Array elements	0	Length	4
Address		Access mode	<symbolic access>	PLC tag	"HMI DATA".FillLevel(in liters)_2"
Coding	IEEE754	PLC name	PLC_1		
Settings					
Acquisition cycle	1 s	Acquisition mode	Cyclic in operation		
Limits					
Upper 2		Upper 1		Lower 1	
Lower 2					
Linear scaling					
Linear scaling	Disabled	PLC value range end value	10	PLC value range start value	0
HMI device value range end value	100	HMI device value range start value	0		
Values					
ID tag		Start value			
Comment					
Comment		Source comment			
Multiplexing					
Multiplexing	Disabled	Index tag			
Logging					
Data log					
GMP (Good Manufacturing Practice)					
Confirmation type	None	GMP relevant	Disabled	Comment required	Disabled

HMI DATA_EmptyTank_2

General					
Name	HMI DATA_EmptyTank_2	Display name		Connection	HMI_Connection_1
Data type	Bool	Array elements	0	Length	1
Address		Access mode	<symbolic access>	PLC tag	"HMI DATA".EmptyTank_2
Coding	Binary	PLC name	PLC_1		
Settings					
Acquisition cycle	1 s	Acquisition mode	Cyclic in operation		
Limits					
Upper 2		Upper 1		Lower 1	
Lower 2					
Linear scaling					
Linear scaling	Disabled	PLC value range end value	10	PLC value range start value	0
HMI device value range end value	100	HMI device value range start value	0		
Values					
ID tag		Start value			
Comment					
Comment		Source comment			
Multiplexing					
Multiplexing	Disabled	Index tag			
Logging					
Data log					
GMP (Good Manufacturing Practice)					
Confirmation type	None	GMP relevant	Disabled	Comment required	Disabled

HMI DATA_Setpoint(in liters)_2

General					
Name	HMI DATA_Setpoint(in liters)_2	Display name		Connection	HMI_Connection_1
Data type	Real	Array elements	0	Length	4

Instrumentation Tools

Totally Integrated Automation Portal					
Address		Access mode	<symbolic access>	PLC tag	"HMI DATA"."Setpoint(in liters)_2"
Coding	IEEE754	PLC name	PLC_1		
Settings					
Acquisition cycle	1 s	Acquisition mode	Cyclic in operation		
Limits					
Upper 2		Upper 1		Lower 1	
Lower 2					
Linear scaling					
Linear scaling	Disabled	PLC value range end value	10	PLC value range start value	0
HMI device value range end value	100	HMI device value range start value	0		
Values					
ID tag		Start value			
Comment					
Comment		Source comment			
Multiplexing					
Multiplexing	Disabled	Index tag			
Logging					
Data log					
GMP (Good Manufacturing Practice)					
Confirmation type	None	GMP relevant	Disabled	Comment required	Disabled

PID_PWM and PID_Output / PC station [SIMATIC PC station] / HMI_RT_1 [WinCC RT Advanced]

Connections

HMI_Connection_1

Name	HMI_Connection_1	Communication driver	SIMATIC S7 1500	Comment	
Online	Enabled	Station	S71500/ET200MP station_1	Partner	PLC_1
Node	CPU 1512C-1 PN, PROFINET interface (R0/S1)	HMI time synchronization mode	None		

Parameter

HMI device					
Interface	ETHERNET	Address	192.168.0.2	Access point	S7ONLINE
PLC					
Address	192.168.0.1				

PID_PWM and PID_Output / PC station [SIMATIC PC station] / HMI_RT_1 [WinCC RT Advanced] / HMI alarms

Discrete alarms

This folder is empty.

Instrumentation Tools

Totally Integrated
Automation Portal

PID_PWM and PID_Output / PC station [SIMATIC PC station] / HMI_RT_1 [WinCC RT Advanced] / HMI alarms

Analog alarms

This folder is empty.

PID_PWM and PID_Output / PC station [SIMATIC PC station] / HMI_RT_1 [WinCC RT Advanced] / HMI alarms

Alarm groups

Alarm_group_1

General			
Name	Alarm_group_1	ID	1

Alarm_group_10

General			
Name	Alarm_group_10	ID	10

Alarm_group_11

General			
Name	Alarm_group_11	ID	11

Alarm_group_12

General			
Name	Alarm_group_12	ID	12

Alarm_group_13

General			
Name	Alarm_group_13	ID	13

Alarm_group_14

General			
Name	Alarm_group_14	ID	14

Alarm_group_15

General			
Name	Alarm_group_15	ID	15

Alarm_group_16

General			
Name	Alarm_group_16	ID	16

Alarm_group_2

General			
Name	Alarm_group_2	ID	2

Alarm_group_3

General			
Name	Alarm_group_3	ID	3

Alarm_group_4

General			
Name	Alarm_group_4	ID	4

Alarm_group_5

General			
Name	Alarm_group_5	ID	5

Alarm_group_6

General			
Name	Alarm_group_6	ID	6

Alarm_group_7

General			
Name	Alarm_group_7	ID	7

Alarm_group_8

General			
Name	Alarm_group_8	ID	8

Alarm_group_9

General			
Name	Alarm_group_9	ID	9

Instrumentation Tools

Totally Integrated Automation Portal																																																																																																																																																																																																																																																																																																								
<p>PID_PWM and PID_Output / PC station [SIMATIC PC station] / HMI_RT_1 [WinCC RT Advanced] / HMI alarms</p> <p>Alarm classes</p> <p>Acknowledgement</p> <table border="1" style="width: 100%; border-collapse: collapse;"> <thead> <tr style="background-color: #e0e0e0;"> <th colspan="6">General</th> </tr> </thead> <tbody> <tr> <td style="width: 15%;">Name</td> <td style="width: 20%;">Acknowledgement</td> <td style="width: 20%;">Display name</td> <td style="width: 15%;">A</td> <td style="width: 15%;">ID</td> <td style="width: 15%;">33</td> </tr> <tr> <td>Common alarm class</td> <td>Acknowledgement</td> <td>Alarm log</td> <td><No log></td> <td>E-mail address</td> <td></td> </tr> <tr style="background-color: #e0e0e0;"> <th colspan="6">Acknowledgment</th> </tr> <tr> <td>State machine</td> <td colspan="5">Alarm with single-mode acknowledgment</td> </tr> <tr style="background-color: #e0e0e0;"> <th colspan="6">State texts</th> </tr> <tr> <td>Text for "Incoming"</td> <td>I</td> <td>Text for "Outgoing"</td> <td>O</td> <td>Text for "Acknowledged"</td> <td>A</td> </tr> <tr style="background-color: #e0e0e0;"> <th colspan="6">Colors</th> </tr> <tr> <td>Background "Incoming/Acknowledged"</td> <td>255, 255, 255</td> <td>"Incoming/Acknowledged" flashing</td> <td>Disabled</td> <td>Background "Incoming"</td> <td>255, 0, 0</td> </tr> <tr> <td>"Incoming" flashing</td> <td>Disabled</td> <td>Background "Incoming/Outgoing/Acknowledged"</td> <td>255, 255, 255</td> <td>"Incoming/Outgoing/Acknowledged" flashing</td> <td>Disabled</td> </tr> <tr> <td>Background "Incoming/Outgoing"</td> <td>255, 0, 0</td> <td>"Incoming/Outgoing" flashing</td> <td>Disabled</td> <td></td> <td></td> </tr> </tbody> </table> <p>Diagnosis events</p> <table border="1" style="width: 100%; border-collapse: collapse;"> <thead> <tr style="background-color: #e0e0e0;"> <th colspan="6">General</th> </tr> </thead> <tbody> <tr> <td style="width: 15%;">Name</td> <td style="width: 20%;">Diagnosis events</td> <td style="width: 20%;">Display name</td> <td style="width: 15%;">S7</td> <td style="width: 15%;">ID</td> <td style="width: 15%;">4</td> </tr> <tr> <td>Common alarm class</td> <td><No alarm class></td> <td>Alarm log</td> <td><No log></td> <td>E-mail address</td> <td></td> </tr> <tr style="background-color: #e0e0e0;"> <th colspan="6">Acknowledgment</th> </tr> <tr> <td>State machine</td> <td colspan="5">Alarm without acknowledgment</td> </tr> <tr style="background-color: #e0e0e0;"> <th colspan="6">State texts</th> </tr> <tr> <td>Text for "Incoming"</td> <td>I</td> <td>Text for "Outgoing"</td> <td>O</td> <td>Text for "Acknowledged"</td> <td>A</td> </tr> <tr style="background-color: #e0e0e0;"> <th colspan="6">Colors</th> </tr> <tr> <td>Background "Incoming/Acknowledged"</td> <td>255, 255, 255</td> <td>"Incoming/Acknowledged" flashing</td> <td>Disabled</td> <td>Background "Incoming"</td> <td>255, 255, 255</td> </tr> <tr> <td>"Incoming" flashing</td> <td>Disabled</td> <td>Background "Incoming/Outgoing/Acknowledged"</td> <td>255, 255, 255</td> <td>"Incoming/Outgoing/Acknowledged" flashing</td> <td>Disabled</td> </tr> <tr> <td>Background "Incoming/Outgoing"</td> <td>255, 255, 255</td> <td>"Incoming/Outgoing" flashing</td> <td>Disabled</td> <td></td> <td></td> </tr> </tbody> </table> <p>Errors</p> <table border="1" style="width: 100%; border-collapse: collapse;"> <thead> <tr style="background-color: #e0e0e0;"> <th colspan="6">General</th> </tr> </thead> <tbody> <tr> <td style="width: 15%;">Name</td> <td style="width: 20%;">Errors</td> <td style="width: 20%;">Display name</td> <td style="width: 15%;">!</td> <td style="width: 15%;">ID</td> <td style="width: 15%;">1</td> </tr> <tr> <td>Common alarm class</td> <td><No alarm class></td> <td>Alarm log</td> <td><No log></td> <td>E-mail address</td> <td></td> </tr> <tr style="background-color: #e0e0e0;"> <th colspan="6">Acknowledgment</th> </tr> <tr> <td>State machine</td> <td colspan="5">Alarm with single-mode acknowledgment</td> </tr> <tr style="background-color: #e0e0e0;"> <th colspan="6">State texts</th> </tr> <tr> <td>Text for "Incoming"</td> <td>I</td> <td>Text for "Outgoing"</td> <td>O</td> <td>Text for "Acknowledged"</td> <td>A</td> </tr> <tr style="background-color: #e0e0e0;"> <th colspan="6">Colors</th> </tr> <tr> <td>Background "Incoming/Acknowledged"</td> <td>255, 255, 255</td> <td>"Incoming/Acknowledged" flashing</td> <td>Disabled</td> <td>Background "Incoming"</td> <td>255, 0, 0</td> </tr> <tr> <td>"Incoming" flashing</td> <td>Disabled</td> <td>Background "Incoming/Outgoing/Acknowledged"</td> <td>255, 255, 255</td> <td>"Incoming/Outgoing/Acknowledged" flashing</td> <td>Disabled</td> </tr> <tr> <td>Background "Incoming/Outgoing"</td> <td>255, 0, 0</td> <td>"Incoming/Outgoing" flashing</td> <td>Disabled</td> <td></td> <td></td> </tr> </tbody> </table> <p>No Acknowledgement</p> <table border="1" style="width: 100%; border-collapse: collapse;"> <thead> <tr style="background-color: #e0e0e0;"> <th colspan="6">General</th> </tr> </thead> <tbody> <tr> <td style="width: 15%;">Name</td> <td style="width: 20%;">No Acknowledgement</td> <td style="width: 20%;">Display name</td> <td style="width: 15%;">NA</td> <td style="width: 15%;">ID</td> <td style="width: 15%;">34</td> </tr> <tr> <td>Common alarm class</td> <td>No Acknowledgement</td> <td>Alarm log</td> <td><No log></td> <td>E-mail address</td> <td></td> </tr> <tr style="background-color: #e0e0e0;"> <th colspan="6">Acknowledgment</th> </tr> <tr> <td>State machine</td> <td colspan="5">Alarm without acknowledgment</td> </tr> <tr style="background-color: #e0e0e0;"> <th colspan="6">State texts</th> </tr> <tr> <td>Text for "Incoming"</td> <td>I</td> <td>Text for "Outgoing"</td> <td>O</td> <td>Text for "Acknowledged"</td> <td>A</td> </tr> <tr style="background-color: #e0e0e0;"> <th colspan="6">Colors</th> </tr> <tr> <td>Background "Incoming/Acknowledged"</td> <td>255, 255, 255</td> <td>"Incoming/Acknowledged" flashing</td> <td>Disabled</td> <td>Background "Incoming"</td> <td>255, 0, 0</td> </tr> <tr> <td>"Incoming" flashing</td> <td>Disabled</td> <td>Background "Incoming/Outgoing/Acknowledged"</td> <td>255, 255, 255</td> <td>"Incoming/Outgoing/Acknowledged" flashing</td> <td>Disabled</td> </tr> <tr> <td>Background "Incoming/Outgoing"</td> <td>255, 0, 0</td> <td>"Incoming/Outgoing" flashing</td> <td>Disabled</td> <td></td> <td></td> </tr> </tbody> </table> <p>System</p> <table border="1" style="width: 100%; border-collapse: collapse;"> <thead> <tr style="background-color: #e0e0e0;"> <th colspan="6">General</th> </tr> </thead> <tbody> <tr> <td style="width: 15%;">Name</td> <td style="width: 20%;">System</td> <td style="width: 20%;">Display name</td> <td style="width: 15%;">\$</td> <td style="width: 15%;">ID</td> <td style="width: 15%;">3</td> </tr> <tr> <td>Common alarm class</td> <td><No alarm class></td> <td>Alarm log</td> <td><No log></td> <td>E-mail address</td> <td></td> </tr> <tr style="background-color: #e0e0e0;"> <th colspan="6">Acknowledgment</th> </tr> <tr> <td>State machine</td> <td colspan="5">Alarm without acknowledgment</td> </tr> </tbody> </table>			General						Name	Acknowledgement	Display name	A	ID	33	Common alarm class	Acknowledgement	Alarm log	<No log>	E-mail address		Acknowledgment						State machine	Alarm with single-mode acknowledgment					State texts						Text for "Incoming"	I	Text for "Outgoing"	O	Text for "Acknowledged"	A	Colors						Background "Incoming/Acknowledged"	255, 255, 255	"Incoming/Acknowledged" flashing	Disabled	Background "Incoming"	255, 0, 0	"Incoming" flashing	Disabled	Background "Incoming/Outgoing/Acknowledged"	255, 255, 255	"Incoming/Outgoing/Acknowledged" flashing	Disabled	Background "Incoming/Outgoing"	255, 0, 0	"Incoming/Outgoing" flashing	Disabled			General						Name	Diagnosis events	Display name	S7	ID	4	Common alarm class	<No alarm class>	Alarm log	<No log>	E-mail address		Acknowledgment						State machine	Alarm without acknowledgment					State texts						Text for "Incoming"	I	Text for "Outgoing"	O	Text for "Acknowledged"	A	Colors						Background "Incoming/Acknowledged"	255, 255, 255	"Incoming/Acknowledged" flashing	Disabled	Background "Incoming"	255, 255, 255	"Incoming" flashing	Disabled	Background "Incoming/Outgoing/Acknowledged"	255, 255, 255	"Incoming/Outgoing/Acknowledged" flashing	Disabled	Background "Incoming/Outgoing"	255, 255, 255	"Incoming/Outgoing" flashing	Disabled			General						Name	Errors	Display name	!	ID	1	Common alarm class	<No alarm class>	Alarm log	<No log>	E-mail address		Acknowledgment						State machine	Alarm with single-mode acknowledgment					State texts						Text for "Incoming"	I	Text for "Outgoing"	O	Text for "Acknowledged"	A	Colors						Background "Incoming/Acknowledged"	255, 255, 255	"Incoming/Acknowledged" flashing	Disabled	Background "Incoming"	255, 0, 0	"Incoming" flashing	Disabled	Background "Incoming/Outgoing/Acknowledged"	255, 255, 255	"Incoming/Outgoing/Acknowledged" flashing	Disabled	Background "Incoming/Outgoing"	255, 0, 0	"Incoming/Outgoing" flashing	Disabled			General						Name	No Acknowledgement	Display name	NA	ID	34	Common alarm class	No Acknowledgement	Alarm log	<No log>	E-mail address		Acknowledgment						State machine	Alarm without acknowledgment					State texts						Text for "Incoming"	I	Text for "Outgoing"	O	Text for "Acknowledged"	A	Colors						Background "Incoming/Acknowledged"	255, 255, 255	"Incoming/Acknowledged" flashing	Disabled	Background "Incoming"	255, 0, 0	"Incoming" flashing	Disabled	Background "Incoming/Outgoing/Acknowledged"	255, 255, 255	"Incoming/Outgoing/Acknowledged" flashing	Disabled	Background "Incoming/Outgoing"	255, 0, 0	"Incoming/Outgoing" flashing	Disabled			General						Name	System	Display name	\$	ID	3	Common alarm class	<No alarm class>	Alarm log	<No log>	E-mail address		Acknowledgment						State machine	Alarm without acknowledgment				
General																																																																																																																																																																																																																																																																																																								
Name	Acknowledgement	Display name	A	ID	33																																																																																																																																																																																																																																																																																																			
Common alarm class	Acknowledgement	Alarm log	<No log>	E-mail address																																																																																																																																																																																																																																																																																																				
Acknowledgment																																																																																																																																																																																																																																																																																																								
State machine	Alarm with single-mode acknowledgment																																																																																																																																																																																																																																																																																																							
State texts																																																																																																																																																																																																																																																																																																								
Text for "Incoming"	I	Text for "Outgoing"	O	Text for "Acknowledged"	A																																																																																																																																																																																																																																																																																																			
Colors																																																																																																																																																																																																																																																																																																								
Background "Incoming/Acknowledged"	255, 255, 255	"Incoming/Acknowledged" flashing	Disabled	Background "Incoming"	255, 0, 0																																																																																																																																																																																																																																																																																																			
"Incoming" flashing	Disabled	Background "Incoming/Outgoing/Acknowledged"	255, 255, 255	"Incoming/Outgoing/Acknowledged" flashing	Disabled																																																																																																																																																																																																																																																																																																			
Background "Incoming/Outgoing"	255, 0, 0	"Incoming/Outgoing" flashing	Disabled																																																																																																																																																																																																																																																																																																					
General																																																																																																																																																																																																																																																																																																								
Name	Diagnosis events	Display name	S7	ID	4																																																																																																																																																																																																																																																																																																			
Common alarm class	<No alarm class>	Alarm log	<No log>	E-mail address																																																																																																																																																																																																																																																																																																				
Acknowledgment																																																																																																																																																																																																																																																																																																								
State machine	Alarm without acknowledgment																																																																																																																																																																																																																																																																																																							
State texts																																																																																																																																																																																																																																																																																																								
Text for "Incoming"	I	Text for "Outgoing"	O	Text for "Acknowledged"	A																																																																																																																																																																																																																																																																																																			
Colors																																																																																																																																																																																																																																																																																																								
Background "Incoming/Acknowledged"	255, 255, 255	"Incoming/Acknowledged" flashing	Disabled	Background "Incoming"	255, 255, 255																																																																																																																																																																																																																																																																																																			
"Incoming" flashing	Disabled	Background "Incoming/Outgoing/Acknowledged"	255, 255, 255	"Incoming/Outgoing/Acknowledged" flashing	Disabled																																																																																																																																																																																																																																																																																																			
Background "Incoming/Outgoing"	255, 255, 255	"Incoming/Outgoing" flashing	Disabled																																																																																																																																																																																																																																																																																																					
General																																																																																																																																																																																																																																																																																																								
Name	Errors	Display name	!	ID	1																																																																																																																																																																																																																																																																																																			
Common alarm class	<No alarm class>	Alarm log	<No log>	E-mail address																																																																																																																																																																																																																																																																																																				
Acknowledgment																																																																																																																																																																																																																																																																																																								
State machine	Alarm with single-mode acknowledgment																																																																																																																																																																																																																																																																																																							
State texts																																																																																																																																																																																																																																																																																																								
Text for "Incoming"	I	Text for "Outgoing"	O	Text for "Acknowledged"	A																																																																																																																																																																																																																																																																																																			
Colors																																																																																																																																																																																																																																																																																																								
Background "Incoming/Acknowledged"	255, 255, 255	"Incoming/Acknowledged" flashing	Disabled	Background "Incoming"	255, 0, 0																																																																																																																																																																																																																																																																																																			
"Incoming" flashing	Disabled	Background "Incoming/Outgoing/Acknowledged"	255, 255, 255	"Incoming/Outgoing/Acknowledged" flashing	Disabled																																																																																																																																																																																																																																																																																																			
Background "Incoming/Outgoing"	255, 0, 0	"Incoming/Outgoing" flashing	Disabled																																																																																																																																																																																																																																																																																																					
General																																																																																																																																																																																																																																																																																																								
Name	No Acknowledgement	Display name	NA	ID	34																																																																																																																																																																																																																																																																																																			
Common alarm class	No Acknowledgement	Alarm log	<No log>	E-mail address																																																																																																																																																																																																																																																																																																				
Acknowledgment																																																																																																																																																																																																																																																																																																								
State machine	Alarm without acknowledgment																																																																																																																																																																																																																																																																																																							
State texts																																																																																																																																																																																																																																																																																																								
Text for "Incoming"	I	Text for "Outgoing"	O	Text for "Acknowledged"	A																																																																																																																																																																																																																																																																																																			
Colors																																																																																																																																																																																																																																																																																																								
Background "Incoming/Acknowledged"	255, 255, 255	"Incoming/Acknowledged" flashing	Disabled	Background "Incoming"	255, 0, 0																																																																																																																																																																																																																																																																																																			
"Incoming" flashing	Disabled	Background "Incoming/Outgoing/Acknowledged"	255, 255, 255	"Incoming/Outgoing/Acknowledged" flashing	Disabled																																																																																																																																																																																																																																																																																																			
Background "Incoming/Outgoing"	255, 0, 0	"Incoming/Outgoing" flashing	Disabled																																																																																																																																																																																																																																																																																																					
General																																																																																																																																																																																																																																																																																																								
Name	System	Display name	\$	ID	3																																																																																																																																																																																																																																																																																																			
Common alarm class	<No alarm class>	Alarm log	<No log>	E-mail address																																																																																																																																																																																																																																																																																																				
Acknowledgment																																																																																																																																																																																																																																																																																																								
State machine	Alarm without acknowledgment																																																																																																																																																																																																																																																																																																							

Instrumentation Tools

Totally Integrated Automation Portal					
State texts					
Text for "Incoming"	I	Text for "Outgoing"	O	Text for "Acknowledged"	A
Colors					
Background "Incoming/Acknowledged"	255, 255, 255	"Incoming/Acknowledged" flashing	Disabled	Background "Incoming"	255, 255, 255
"Incoming" flashing	Disabled	Background "Incoming/Outgoing/Acknowledged"	255, 255, 255	"Incoming/Outgoing/Acknowledged" flashing	Disabled
Background "Incoming/Outgoing"	255, 255, 255	"Incoming/Outgoing" flashing	Disabled		
Warnings					
General					
Name	Warnings	Display name		ID	2
Common alarm class	<No alarm class>	Alarm log	<No log>	E-mail address	
Acknowledgment					
State machine	Alarm without acknowledgment				
State texts					
Text for "Incoming"	I	Text for "Outgoing"	O	Text for "Acknowledged"	A
Colors					
Background "Incoming/Acknowledged"	255, 255, 255	"Incoming/Acknowledged" flashing	Disabled	Background "Incoming"	255, 255, 255
"Incoming" flashing	Disabled	Background "Incoming/Outgoing/Acknowledged"	255, 255, 255	"Incoming/Outgoing/Acknowledged" flashing	Disabled
Background "Incoming/Outgoing"	255, 255, 255	"Incoming/Outgoing" flashing	Disabled		

PID_PWM and PID_Output / PC station [SIMATIC PC station] / HMI_RT_1 [WinCC RT Advanced] / HMI alarms

Controller alarms

This folder is empty.

Instrumentation Tools

Totally Integrated
Automation Portal

PID_PWM and PID_Output / PC station [SIMATIC PC station] / HMI_RT_1 [WinCC RT Advanced] / HMI alarms

System events

This folder is empty.

PID_PWM and PID_Output / PC station [SIMATIC PC station] / HMI_RT_1 [WinCC RT Advanced]

Recipes

This folder is empty.

PID_PWM and PID_Output / PC station [SIMATIC PC station] / HMI_RT_1 [WinCC RT Advanced] /
Historical data

Datalogs

This folder is empty.

PID_PWM and PID_Output / PC station [SIMATIC PC station] / HMI_RT_1 [WinCC RT Advanced] /
Historical data

AlarmLogs

This folder is empty.

PID_PWM and PID_Output / PC station [SIMATIC PC station] / HMI_RT_1 [WinCC RT Advanced] / Scripts

VB scripts

This folder is empty.

Instrumentation Tools

Totally Integrated
Automation Portal

PID_PWM and PID_Output / PC station [SIMATIC PC station] / HMI_RT_1 [WinCC RT Advanced]

Scheduled tasks

This folder is empty.

PID_PWM and PID_Output / PC station [SIMATIC PC station] / HMI_RT_1 [WinCC RT Advanced]

Cycles

1 h

General					
Name	1 h	Cycle time	1	Cycle unit	hours
Comment					
Comment					

1 min

General					
Name	1 min	Cycle time	1	Cycle unit	minutes
Comment					
Comment					

1 s

General					
Name	1 s	Cycle time	1	Cycle unit	seconds
Comment					
Comment					

10 min

General					
Name	10 min	Cycle time	10	Cycle unit	minutes
Comment					
Comment					

10 s

General					
Name	10 s	Cycle time	10	Cycle unit	seconds
Comment					
Comment					

100 ms

General					
Name	100 ms	Cycle time	100	Cycle unit	milliseconds
Comment					
Comment					

2 s

General					
Name	2 s	Cycle time	2	Cycle unit	seconds
Comment					
Comment					

5 min

General					
Name	5 min	Cycle time	5	Cycle unit	minutes
Comment					
Comment					

5 s

General					
Name	5 s	Cycle time	5	Cycle unit	seconds
Comment					
Comment					

500 ms

General					
Name	500 ms	Cycle time	500	Cycle unit	milliseconds
Comment					
Comment					

PID_PWM and PID_Output / PC station [SIMATIC PC station] / HMI_RT_1 [WinCC RT Advanced]

Reports

This folder is empty.

Instrumentation Tools

Totally Integrated Automation Portal

PID_PWM and PID_Output / PC station [SIMATIC PC station] / HMI_RT_1 [WinCC RT Advanced] / Text and graphic lists

Text lists

Controller Type

Name	Controller Type	List range	Value/Range	Comment
Value: 1				
Entry type	Single value		Text	Manual
Value: 2				
Entry type	Single value		Text	ON/OFF
Value: 3				
Entry type	Single value		Text	ON/OFF with hysteresis
Value: Default entry				
Entry type	Single value		Text	OFF
Value: 0				
Entry type	Single value		Text	OFF

Random Disturbance

Name	Random Disturbance	List range	Value/Range	Comment
Value: 1				
Entry type	Single value		Text	OFF
Value: 2				
Entry type	Single value		Text	WEAK
Value: 3				
Entry type	Single value		Text	MEDIUM
Value: 4				
Entry type	Single value		Text	STRONG
Value: Default entry				
Entry type	Single value		Text	OFF

PID_PWM and PID_Output / PC station [SIMATIC PC station] / HMI_RT_1 [WinCC RT Advanced] /
Text and graphic lists

Graphic lists

This folder is empty.

PID_PWM and PID_Output / PC station [SIMATIC PC station] / HMI_RT_1 [WinCC RT Advanced] / User administration

User

Administrator

General			
Name	Administrator	Number	1
Automatic logoff			
Automatic logoff	Enabled	Logoff time	5
Comment			
Comment	The user 'Administrator' is assigned to the 'Administrator' group.		
Groups			
Groups	Administrator group;		

PID_PWM and PID_Output / PC station [SIMATIC PC station] / HMI_RT_1 [WinCC RT Advanced] / User administration

Groups

Administrator group

General			
Name	Administrator group	Display name	Administrator group
Number	1	Password aging	Disabled
Comment			
Comment	The 'Administrator' group is initially granted all rights.		
Authorizations			
Authorizations	User administration; Monitor; Operate;		

Users

General			
Name	Users	Display name	Users
Number	2	Password aging	Disabled
Comment			
Comment	The 'Users' group is initially granted 'Operating' rights.		
Authorizations			
Authorizations	Operate;		

PID_PWM and PID_Output / PC station [SIMATIC PC station] / HMI_RT_1 [WinCC RT Advanced] / User administration

Authorizations

Monitor

General			
Name	Monitor	Authorization	Monitor
Authorization number	2		
Comment			
Comment	'Monitor' authorization.		

Operate

General			
Name	Operate	Authorization	Operate
Authorization number	3		
Comment			
Comment	'Operate' authorization.		

User administration

General			
Name	User administration	Authorization	User administration
Authorization number	1		
Comment			
Comment	Authorization 'User administration' for managing users in the user view in Runtime.		

Totally Integrated Automation Portal		
<h2 style="margin: 0;">PID_PWM and PID_Output / PC station [SIMATIC PC station] / Local modules</h2> <h3 style="margin: 0;">IE general_1</h3>		
IE general_1		
General		
Name	IE general_1	Author Mmuhamed
Slot	1	Comment
General\Catalog information		
Short designation	IE general	Description Substitute for any Industrial Ethernet module, ISO, TCP/IP, S7 connections, PG functions, routing, PROFINET IO controller, prioritized startup, ... SIMATIC NET PC software V8.2
Article number	IE_CP	Software version V8.2.0
General\Identification & Maintenance		
Plant designation		Location identifier
PROFINET interface [X1]\General		
Name	PROFINET interface	Comment
PROFINET interface [X1]\Options\Connection establishment monitoring		
Timeout	10s	
PROFINET interface [X1]\Ethernet addresses\Interface networked with		
Subnet:	PN/IE_1	
PROFINET interface [X1]\Ethernet addresses\ISO protocol		
Use ISO protocol	False	
PROFINET interface [X1]\Ethernet addresses\IP protocol		
Use IP protocol	True	IP address: 192.168.0.2
Use router	False	Subnet mask: 255.255.255.0
PROFINET interface [X1]\Ethernet addresses\PROFINET		
Generate PROFINET device name automatically	True	PROFINET device name: pc station.ie general_1
Converted name:	pcxastation.iexageneralxb12716	Device number: 0
PROFINET interface [X1]\Advanced options\Interface options		
Use IEC V2.2 LLDP mode	True	Keep-Alive connection monitoring: 30s
PROFINET interface [X1]\Advanced options\Port [X1 P1]\General		
Name	Port_1	Comment
PROFINET interface [X1]\Advanced options\Port [X1 P1]\Port interconnection\Local port:		
Local port:	IE general_1\PROFINET interface [X1]\Port_1 [X1 P1]	Medium: Copper
Cable name:	---	
		
PROFINET interface [X1]\Advanced options\Port [X1 P1]\Port interconnection\Partner port:		
	Monitoring of partner port is not possible	Partner port: Any partner

PID_PWM and PID_Output

Ungrouped devices

This folder is empty.

PID_PWM and PID_Output

Security settings

This folder is empty.

PID_PWM and PID_Output / Cross-device functions / Project traces

Measurements

This folder is empty.

PID_PWM and PID_Output / Common data

Alarm classes

Alarm classes			
Name	Display name	Acknowledgment	Priority
Acknowledgement	A	True	0
No Acknowledgement	NA	False	0

PID_PWM and PID_Output / Common data

Logs

This folder is empty.

PID_PWM and PID_Output / Common data

Styles

This folder is empty.

PID_PWM and PID_Output / Languages & resources

Project languages

Languages

Reference language

English (United States)

Editing language

English (United States)

Other project languages

Empty

Instrumentation Tools

Totally Integrated Automation Portal

PID_PWM and PID_Output / Languages & resources / Project texts

Project texts

Project texts		
English (United States)	Category	Reference
	Alarm class text	PID_PWM and PID_Output\PC station [SIMATIC PC station]\HMI_RT_1 [WinCC RT Advanced]\HMI alarms\Errors\alarmclass name not set\ShortName
	Alarm class text	PID_PWM and PID_Output\PC station [SIMATIC PC station]\HMI_RT_1 [WinCC RT Advanced]\HMI alarms\Warnings\alarmclass name not set_1\ShortName
	Alarm class text	PID_PWM and PID_Output\PC station [SIMATIC PC station]\HMI_RT_1 [WinCC RT Advanced]\HMI alarms\System\alarmclass name not set_2\ShortName
	Alarm class text	PID_PWM and PID_Output\PC station [SIMATIC PC station]\HMI_RT_1 [WinCC RT Advanced]\HMI alarms\Diagnosis events\alarmclass name not set_3\ShortName
	Alarm class text	PID_PWM and PID_Output\PC station [SIMATIC PC station]\HMI_RT_1 [WinCC RT Advanced]\HMI alarms\Safety warnings\alarmclass name not set_4\ShortName
	Alarm class text	PID_PWM and PID_Output\PC station [SIMATIC PC station]\HMI_RT_1 [WinCC RT Advanced]\HMI alarms\Acknowledgement\ShortName
	Alarm class text	PID_PWM and PID_Output\PC station [SIMATIC PC station]\HMI_RT_1 [WinCC RT Advanced]\HMI alarms\No Acknowledgement\ShortName
	Alarm text	PID_PWM and PID_Output\PC station [SIMATIC PC station]\HMI_RT_1 [WinCC RT Advanced]\HMI alarms\Warnings\alarmclass name not set_1\AlarmClassData_IDisplayNaming_DisplayName
	Alarm text	PID_PWM and PID_Output\PC station [SIMATIC PC station]\HMI_RT_1 [WinCC RT Advanced]\HMI alarms\Acknowledgement\AlarmClassData_IDisplayNaming_DisplayName
	Alarm text	PID_PWM and PID_Output\PC station [SIMATIC PC station]\HMI_RT_1 [WinCC RT Advanced]\HMI alarms\No Acknowledgement\AlarmClassData_IDisplayNaming_DisplayName
!	Alarm text	PID_PWM and PID_Output\PC station [SIMATIC PC station]\HMI_RT_1 [WinCC RT Advanced]\HMI alarms\Errors\alarmclass name not set\AlarmClassData_IDisplayNaming_DisplayName
!!	Alarm text	PID_PWM and PID_Output\PC station [SIMATIC PC station]\HMI_RT_1 [WinCC RT Advanced]\HMI alarms\Safety warnings\alarmclass name not set_4\AlarmClassData_IDisplayNaming_DisplayName
"Main Program Sweep (Cycle)"	Block comment	PID_PWM and PID_Output\PLC_1 [CPU 1512C-1 PN]\Program blocks\Main [OB1]\Block title
\$	Alarm text	PID_PWM and PID_Output\PC station [SIMATIC PC station]\HMI_RT_1 [WinCC RT Advanced]\HMI alarms\System\alarmclass name not set_2\AlarmClassData_IDisplayNaming_DisplayName
PID_Output	HMI screen	PID_PWM and PID_Output\PC station [SIMATIC PC station]\HMI_RT_1 [WinCC RT Advanced]\Screens\Control\Text field_6\Text
PID_PWM	HMI screen	PID_PWM and PID_Output\PC station [SIMATIC PC station]\HMI_RT_1 [WinCC RT Advanced]\Screens\Control\Text field_9\Text
0	HMI screen	PID_PWM and PID_Output\PC station [SIMATIC PC station]\HMI_RT_1 [WinCC RT Advanced]\Screens\Control\Symbolic I/O field_2\Text OFF
0	HMI screen	PID_PWM and PID_Output\PC station [SIMATIC PC station]\HMI_RT_1 [WinCC RT Advanced]\Screens\Control\Symbolic I/O field_1\Text OFF
1	HMI screen	PID_PWM and PID_Output\PC station [SIMATIC PC station]\HMI_RT_1 [WinCC RT Advanced]\Screens\Control\Symbolic I/O field_2\Text ON
1	HMI screen	PID_PWM and PID_Output\PC station [SIMATIC PC station]\HMI_RT_1 [WinCC RT Advanced]\Screens\Control\Symbolic I/O field_1\Text ON
A	Alarm class text	PID_PWM and PID_Output\Acknowledgement\AlarmClassData_IDisplayNaming_DisplayName
A	Alarm class text	PID_PWM and PID_Output\Acknowledgement\ShortName
A	Alarm text	PID_PWM and PID_Output\PC station [SIMATIC PC station]\HMI_RT_1 [WinCC RT Advanced]\HMI alarms\Errors\AcknowledgedText
A	Alarm text	PID_PWM and PID_Output\PC station [SIMATIC PC station]\HMI_RT_1 [WinCC RT Advanced]\HMI alarms\Warnings\AcknowledgedText
A	Alarm text	PID_PWM and PID_Output\PC station [SIMATIC PC station]\HMI_RT_1 [WinCC RT Advanced]\HMI alarms\System\AcknowledgedText
A	Alarm text	PID_PWM and PID_Output\PC station [SIMATIC PC station]\HMI_RT_1 [WinCC RT Advanced]\HMI alarms\Diagnosis events\AcknowledgedText
A	Alarm text	PID_PWM and PID_Output\PC station [SIMATIC PC station]\HMI_RT_1 [WinCC RT Advanced]\HMI alarms\Safety warnings\AcknowledgedText
A	Alarm text	PID_PWM and PID_Output\PC station [SIMATIC PC station]\HMI_RT_1 [WinCC RT Advanced]\HMI alarms\Acknowledgement\AcknowledgedText
A	Alarm text	PID_PWM and PID_Output\PC station [SIMATIC PC station]\HMI_RT_1 [WinCC RT Advanced]\HMI alarms\No Acknowledgement\AcknowledgedText
A level sensor will convert a 0-50liters level measurements into a 0-10 V signal. which then goes into the PLC Input module	Block comment	PID_PWM and PID_Output\PLC_1 [CPU 1512C-1 PN]\Program blocks\AnalogInputs [FC1]\Network 1\Comment
Activates remote authorization for the use of client-server scenarios.	HMI comment	PID_PWM and PID_Output\PC station [SIMATIC PC station]\HMI_RT_1 [WinCC RT Advanced]\User administration\Enable remote control\Comment
Administrator group	HMI runtime	PID_PWM and PID_Output\PC station [SIMATIC PC station]\HMI_RT_1 [WinCC RT Advanced]\User administration\Administrator group\DisplayName
Authorization 'User administration' for managing users in the user view in Runtime.	HMI comment	PID_PWM and PID_Output\PC station [SIMATIC PC station]\HMI_RT_1 [WinCC RT Advanced]\User administration\User administration\Comment
Compact PID_Controller with self-tuning	Block comment	PID_PWM and PID_Output\PLC_1 [CPU 1512C-1 PN]\Program blocks\System blocks\Program resources\PID_Compact [FB1130]\Block title
configuration data set	Block comment	PID_PWM and PID_Output\PLC_1 [CPU 1512C-1 PN]\PLC data types\System data types\PID_CompactConfig\Title of the PLC data type
controlling parameter set	Block comment	PID_PWM and PID_Output\PLC_1 [CPU 1512C-1 PN]\PLC data types\System data types\PID_CompactControlParams\Title of the PLC data type
data for controlling part	Block comment	PID_PWM and PID_Output\PLC_1 [CPU 1512C-1 PN]\PLC data types\System data types\PID_CompactControl\Title of the PLC data type
data for estimation of deviance	Block comment	PID_PWM and PID_Output\PLC_1 [CPU 1512C-1 PN]\PLC data types\System data types\PID_StandardDeviation\Title of the PLC data type
data for scaling	Block comment	PID_PWM and PID_Output\PLC_1 [CPU 1512C-1 PN]\PLC data types\System data types\PID_Scaling\Title of the PLC data type
data set for cycle time estimation	Block comment	PID_PWM and PID_Output\PLC_1 [CPU 1512C-1 PN]\PLC data types\System data types\PID_CycleTime\Title of the PLC data type
data set for self tuning	Block comment	PID_PWM and PID_Output\PLC_1 [CPU 1512C-1 PN]\PLC data types\System data types\PID_CompactSelfTune\Title of the PLC data type
data set for start up tuning	Block comment	PID_PWM and PID_Output\PLC_1 [CPU 1512C-1 PN]\PLC data types\System data types\PID_Compact_SUT\Title of the PLC data type

Instrumentation Tools

Totally Integrated Automation Portal			
English (United States)	Category	Reference	
data set for tuning in run	Block comment	PID_PWM and PID_Output\PLC_1 [CPU 1512C-1 PN]\PLC data types\System data types \PID_Compact_TIR\Title of the PLC data type	
dataset of parameters for gradient estimation	Block comment	PID_PWM and PID_Output\PLC_1 [CPU 1512C-1 PN]\PLC data types\System data types\PID_GradientParams\Title of the PLC data type	
Derivative gain	HMI screen	PID_PWM and PID_Output\PC station [SIMATIC PC station]\HMI_RT_1 [WinCC RT Advanced] \Screens\Control\Text field_8\Text	
Derivative gain	HMI screen	PID_PWM and PID_Output\PC station [SIMATIC PC station]\HMI_RT_1 [WinCC RT Advanced] \Screens\Control\Text field_18\Text	
Disturbance	HMI screen	PID_PWM and PID_Output\PC station [SIMATIC PC station]\HMI_RT_1 [WinCC RT Advanced] \Screens\Control\Text field_4\Text	
Disturbance	HMI screen	PID_PWM and PID_Output\PC station [SIMATIC PC station]\HMI_RT_1 [WinCC RT Advanced] \Screens\Control\Text field_14\Text	
Disturbance- outflow	Block comment	PID_PWM and PID_Output\PLC_1 [CPU 1512C-1 PN]\Program blocks\tank Simulator [FB2]\Network 9\Title	
Disturbance- random	Block comment	PID_PWM and PID_Output\PLC_1 [CPU 1512C-1 PN]\Program blocks\tank Simulator [FB2]\Network 8\Title	
Empty Tank	HMI screen	PID_PWM and PID_Output\PC station [SIMATIC PC station]\HMI_RT_1 [WinCC RT Advanced] \Screens\Control\Button_1\Text OFF	
Empty Tank	HMI screen	PID_PWM and PID_Output\PC station [SIMATIC PC station]\HMI_RT_1 [WinCC RT Advanced] \Screens\Control\Button_2\Text OFF	
empty tank and PID integral sum	Block comment	PID_PWM and PID_Output\PLC_1 [CPU 1512C-1 PN]\Program blocks\Main [OB1]\Network 5\Title	
fill level clamping	Block comment	PID_PWM and PID_Output\PLC_1 [CPU 1512C-1 PN]\Program blocks\tank Simulator [FB2]\Network 10\Title	
I	Alarm text	PID_PWM and PID_Output\PC station [SIMATIC PC station]\HMI_RT_1 [WinCC RT Advanced] \HMI alarms\Errors\ComingText	
I	Alarm text	PID_PWM and PID_Output\PC station [SIMATIC PC station]\HMI_RT_1 [WinCC RT Advanced] \HMI alarms\Warnings\ComingText	
I	Alarm text	PID_PWM and PID_Output\PC station [SIMATIC PC station]\HMI_RT_1 [WinCC RT Advanced] \HMI alarms\System\ComingText	
I	Alarm text	PID_PWM and PID_Output\PC station [SIMATIC PC station]\HMI_RT_1 [WinCC RT Advanced] \HMI alarms\Diagnosis events\ComingText	
I	Alarm text	PID_PWM and PID_Output\PC station [SIMATIC PC station]\HMI_RT_1 [WinCC RT Advanced] \HMI alarms\Safety warnings\ComingText	
I	Alarm text	PID_PWM and PID_Output\PC station [SIMATIC PC station]\HMI_RT_1 [WinCC RT Advanced] \HMI alarms\Acknowledgement\ComingText	
I	Alarm text	PID_PWM and PID_Output\PC station [SIMATIC PC station]\HMI_RT_1 [WinCC RT Advanced] \HMI alarms\No Acknowledgement\ComingText	
Idle Time	HMI screen	PID_PWM and PID_Output\PC station [SIMATIC PC station]\HMI_RT_1 [WinCC RT Advanced] \Screens\Control\Text field_5\Text	
Idle Time	HMI screen	PID_PWM and PID_Output\PC station [SIMATIC PC station]\HMI_RT_1 [WinCC RT Advanced] \Screens\Control\Text field_15\Text	
Idle time clamping	Block comment	PID_PWM and PID_Output\PLC_1 [CPU 1512C-1 PN]\Program blocks\tank Simulator [FB2]\Network 2\Title	
Integral gain	HMI screen	PID_PWM and PID_Output\PC station [SIMATIC PC station]\HMI_RT_1 [WinCC RT Advanced] \Screens\Control\Text field_7\Text	
Integral gain	HMI screen	PID_PWM and PID_Output\PC station [SIMATIC PC station]\HMI_RT_1 [WinCC RT Advanced] \Screens\Control\Text field_17\Text	
IO	Alarm text	PID_PWM and PID_Output\PC station [SIMATIC PC station]\HMI_RT_1 [WinCC RT Advanced] \HMI alarms\Errors\ComingGoingText	
IO	Alarm text	PID_PWM and PID_Output\PC station [SIMATIC PC station]\HMI_RT_1 [WinCC RT Advanced] \HMI alarms\Warnings\ComingGoingText	
IO	Alarm text	PID_PWM and PID_Output\PC station [SIMATIC PC station]\HMI_RT_1 [WinCC RT Advanced] \HMI alarms\System\ComingGoingText	
IO	Alarm text	PID_PWM and PID_Output\PC station [SIMATIC PC station]\HMI_RT_1 [WinCC RT Advanced] \HMI alarms\Diagnosis events\ComingGoingText	
IO	Alarm text	PID_PWM and PID_Output\PC station [SIMATIC PC station]\HMI_RT_1 [WinCC RT Advanced] \HMI alarms\Safety warnings\ComingGoingText	
IO	Alarm text	PID_PWM and PID_Output\PC station [SIMATIC PC station]\HMI_RT_1 [WinCC RT Advanced] \HMI alarms\Acknowledgement\ComingGoingText	
IO	Alarm text	PID_PWM and PID_Output\PC station [SIMATIC PC station]\HMI_RT_1 [WinCC RT Advanced] \HMI alarms\No Acknowledgement\ComingGoingText	
Manual	HMI runtime	PID_PWM and PID_Output\PC station [SIMATIC PC station]\HMI_RT_1 [WinCC RT Advanced] \Text and graphic lists\Controller Type\Text_list_entry_1\Text	
MEDIUM	HMI runtime	PID_PWM and PID_Output\PC station [SIMATIC PC station]\HMI_RT_1 [WinCC RT Advanced] \Text and graphic lists\Random Disturbance\Text_list_entry_4\Text	
Monitor	HMI runtime	PID_PWM and PID_Output\PC station [SIMATIC PC station]\HMI_RT_1 [WinCC RT Advanced] \User administration\Monitor\ShortName	
'Monitor' authorization.	HMI comment	PID_PWM and PID_Output\PC station [SIMATIC PC station]\HMI_RT_1 [WinCC RT Advanced] \User administration\Monitor\Comment	
NA	Alarm class text	PID_PWM and PID_Output\No Acknowledgement\AlarmClassData_IDisplayNaming_DisplayName	
NA	Alarm class text	PID_PWM and PID_Output\No Acknowledgement\ShortName	
O	Alarm text	PID_PWM and PID_Output\PC station [SIMATIC PC station]\HMI_RT_1 [WinCC RT Advanced] \HMI alarms\Errors\GoingText	
O	Alarm text	PID_PWM and PID_Output\PC station [SIMATIC PC station]\HMI_RT_1 [WinCC RT Advanced] \HMI alarms\Warnings\GoingText	
O	Alarm text	PID_PWM and PID_Output\PC station [SIMATIC PC station]\HMI_RT_1 [WinCC RT Advanced] \HMI alarms\System\GoingText	
O	Alarm text	PID_PWM and PID_Output\PC station [SIMATIC PC station]\HMI_RT_1 [WinCC RT Advanced] \HMI alarms\Diagnosis events\GoingText	
O	Alarm text	PID_PWM and PID_Output\PC station [SIMATIC PC station]\HMI_RT_1 [WinCC RT Advanced] \HMI alarms\Safety warnings\GoingText	
O	Alarm text	PID_PWM and PID_Output\PC station [SIMATIC PC station]\HMI_RT_1 [WinCC RT Advanced] \HMI alarms\Acknowledgement\GoingText	
O	Alarm text	PID_PWM and PID_Output\PC station [SIMATIC PC station]\HMI_RT_1 [WinCC RT Advanced] \HMI alarms\No Acknowledgement\GoingText	
OFF	HMI runtime	PID_PWM and PID_Output\PC station [SIMATIC PC station]\HMI_RT_1 [WinCC RT Advanced] \Text and graphic lists\Controller Type\Text_list_entry_4\Text	
OFF	HMI runtime	PID_PWM and PID_Output\PC station [SIMATIC PC station]\HMI_RT_1 [WinCC RT Advanced] \Text and graphic lists\Random Disturbance\Text_list_entry_5\Text	

Instrumentation Tools

Totally Integrated Automation Portal			
English (United States)	Category	Reference	
OFF	HMI runtime	PID_PWM and PID_Output\PC station [SIMATIC PC station]\HMI_RT_1 [WinCC RT Advanced]\Text and graphic lists\Random Disturbance\Text_list_entry_2\Text	
OFF	HMI runtime	PID_PWM and PID_Output\PC station [SIMATIC PC station]\HMI_RT_1 [WinCC RT Advanced]\Text and graphic lists\Controller Type\Text_list_entry_5\Text	
ON/OFF	HMI runtime	PID_PWM and PID_Output\PC station [SIMATIC PC station]\HMI_RT_1 [WinCC RT Advanced]\Text and graphic lists\Controller Type\Text_list_entry_2\Text	
ON/OFF with hysteresis	HMI runtime	PID_PWM and PID_Output\PC station [SIMATIC PC station]\HMI_RT_1 [WinCC RT Advanced]\Text and graphic lists\Controller Type\Text_list_entry_3\Text	
Operate	HMI runtime	PID_PWM and PID_Output\PC station [SIMATIC PC station]\HMI_RT_1 [WinCC RT Advanced]\User administration\Operate\ShortName	
'Operate' authorization.	HMI comment	PID_PWM and PID_Output\PC station [SIMATIC PC station]\HMI_RT_1 [WinCC RT Advanced]\User administration\Operate\Comment	
OutFlow	HMI screen	PID_PWM and PID_Output\PC station [SIMATIC PC station]\HMI_RT_1 [WinCC RT Advanced]\Screens\Control\Text field_3\Text	
OutFlow	HMI screen	PID_PWM and PID_Output\PC station [SIMATIC PC station]\HMI_RT_1 [WinCC RT Advanced]\Screens\Control\Text field_13\Text	
OUTPTUT	HMI screen	PID_PWM and PID_Output\PC station [SIMATIC PC station]\HMI_RT_1 [WinCC RT Advanced]\Screens\Control\Text field_10\Text	
OUTPTUT	HMI screen	PID_PWM and PID_Output\PC station [SIMATIC PC station]\HMI_RT_1 [WinCC RT Advanced]\Screens\Control\Text field_19\Text	
PID controller for TANK2	Block comment	PID_PWM and PID_Output\PLC_1 [CPU 1512C-1 PN]\Program blocks\Cyclic interrupt_TankLevel_PID_PWM [OB33]\Network 1\Title	
PLC output module will take the output value 0-32767 and convert it to analog range of 0-10V	Block comment	PID_PWM and PID_Output\PLC_1 [CPU 1512C-1 PN]\Program blocks\AnalogOutputs [FC2]\Network 1\Comment	
Proportial gain	HMI screen	PID_PWM and PID_Output\PC station [SIMATIC PC station]\HMI_RT_1 [WinCC RT Advanced]\Screens\Control\Text field_2\Text	
Proportial gain	HMI screen	PID_PWM and PID_Output\PC station [SIMATIC PC station]\HMI_RT_1 [WinCC RT Advanced]\Screens\Control\Text field_16\Text	
Pump flow	HMI screen	PID_PWM and PID_Output\PC station [SIMATIC PC station]\HMI_RT_1 [WinCC RT Advanced]\Screens\Control\Text field_11\Text	
Pump flow	HMI screen	PID_PWM and PID_Output\PC station [SIMATIC PC station]\HMI_RT_1 [WinCC RT Advanced]\Screens\Control\Text field_20\Text	
pump output memory	Block comment	PID_PWM and PID_Output\PLC_1 [CPU 1512C-1 PN]\Program blocks\Tank Simulator [FB2]\Network 3\Title	
QGR	Alarm text	PID_PWM and PID_Output\PC station [SIMATIC PC station]\HMI_RT_1 [WinCC RT Advanced]\Runtime settings\HmiAlarmSettingsData\AcknowledgementGroupText	
random disturbance strength	Block comment	PID_PWM and PID_Output\PLC_1 [CPU 1512C-1 PN]\Program blocks\Tank Simulator [FB2]\Network 7\Title	
Random value for disturbance - 1st step	Block comment	PID_PWM and PID_Output\PLC_1 [CPU 1512C-1 PN]\Program blocks\Tank Simulator [FB2]\Network 5\Title	
random value of disturbance- 2nd step	Block comment	PID_PWM and PID_Output\PLC_1 [CPU 1512C-1 PN]\Program blocks\Tank Simulator [FB2]\Network 6\Title	
retain data	Block comment	PID_PWM and PID_Output\PLC_1 [CPU 1512C-1 PN]\PLC data types\System data types\PID_CompactRetain\Title of the PLC data type	
S7	Alarm text	PID_PWM and PID_Output\PC station [SIMATIC PC station]\HMI_RT_1 [WinCC RT Advanced]\HMI alarms\Diagnosis events\alarmclass name not set_3\AlarmClassData_IDisplayNaming_DisplayName	
Set Point	HMI screen	PID_PWM and PID_Output\PC station [SIMATIC PC station]\HMI_RT_1 [WinCC RT Advanced]\Screens\Control\Text field_1\Text	
Set Point	HMI screen	PID_PWM and PID_Output\PC station [SIMATIC PC station]\HMI_RT_1 [WinCC RT Advanced]\Screens\Control\Text field_12\Text	
setpoint clamping	Block comment	PID_PWM and PID_Output\PLC_1 [CPU 1512C-1 PN]\Program blocks\Tank Simulator [FB2]\Network 1\Title	
simulation of TANK1 analog input of the level sensor to the PLC	Block comment	PID_PWM and PID_Output\PLC_1 [CPU 1512C-1 PN]\Program blocks\Main [OB1]\Network 1\Title	
simulation of TANK2 analog input of the level sensor to the PLC	Block comment	PID_PWM and PID_Output\PLC_1 [CPU 1512C-1 PN]\Program blocks\Main [OB1]\Network 2\Title	
Simulation of the behaviour of the pump of 0-10 liters/sec in corresponding to 0-10v PLC output	Block comment	PID_PWM and PID_Output\PLC_1 [CPU 1512C-1 PN]\Program blocks\Main [OB1]\Network 3\Title	
SIMULATION OF THE TANK2 pump output corresponding to the ON/OFF behavior of the PID_PWM	Block comment	PID_PWM and PID_Output\PLC_1 [CPU 1512C-1 PN]\Program blocks\Main [OB1]\Network 4\Title	
STRONG	HMI runtime	PID_PWM and PID_Output\PC station [SIMATIC PC station]\HMI_RT_1 [WinCC RT Advanced]\Text and graphic lists\Random Disturbance\Text_list_entry_1\Text	
structure for gradient estimation	Block comment	PID_PWM and PID_Output\PLC_1 [CPU 1512C-1 PN]\PLC data types\System data types\PID_GradientEstimation\Title of the PLC data type	
tank 1 simulator	Block comment	PID_PWM and PID_Output\PLC_1 [CPU 1512C-1 PN]\Program blocks\Cyclic_interrupt_1ms_TANK1Simulation [OB32]\Network 1\Title	
Tank level progress	Block comment	PID_PWM and PID_Output\PLC_1 [CPU 1512C-1 PN]\Program blocks\Tank Simulator [FB2]\Network 4\Title	
Text	HMI screen	PID_PWM and PID_Output\PC station [SIMATIC PC station]\HMI_RT_1 [WinCC RT Advanced]\Screens\Control\Button_1\Text ON	
Text	HMI screen	PID_PWM and PID_Output\PC station [SIMATIC PC station]\HMI_RT_1 [WinCC RT Advanced]\Screens\Control\Button_2\Text ON	
the 0-10V readings at the input module will be converted to the 0-50 liters measurements of the sensor	Block comment	PID_PWM and PID_Output\PLC_1 [CPU 1512C-1 PN]\Program blocks\AnalogInputs [FC1]\Network 2\Comment	
The 'Administrator' group is initially granted all rights.	HMI comment	PID_PWM and PID_Output\PC station [SIMATIC PC station]\HMI_RT_1 [WinCC RT Advanced]\User administration\Administrator group\Comment	
The user 'Administrator' is assigned to the 'Administrator' group.	HMI comment	PID_PWM and PID_Output\PC station [SIMATIC PC station]\HMI_RT_1 [WinCC RT Advanced]\User administration\Administrator\Comment	
The 'Users' group is initially granted 'Operating' rights.	HMI comment	PID_PWM and PID_Output\PC station [SIMATIC PC station]\HMI_RT_1 [WinCC RT Advanced]\User administration\Users\Comment	
this block will simulate the exsistance of a real level sensor. we don't acutally have a real level sensor, so we will simulate this sensor as fow low	Block comment	PID_PWM and PID_Output\PLC_1 [CPU 1512C-1 PN]\Program blocks\AnalogInputs [FC1]\Block comment	

Instrumentation Tools

Totally Integrated Automation Portal		
English (United States)	Category	Reference
This code is collecting and processing pump flow rates and tank status. It calculates the average pump flow rate over a 1ms(which is the calling interval of the cyclic interrupt) interval and resets the data if the tank is empty is activ.	Block comment	PID_PWM and PID_Output\PLC_1 [CPU 1512C-1 PN]\Program blocks\tank Simulator [FB2]\Network 3\Comment
User administration	HMI runtime	PID_PWM and PID_Output\PC station [SIMATIC PC station]\HMI_RT_1 [WinCC RT Advanced]\User administration\User administration\ShortName
Users	HMI runtime	PID_PWM and PID_Output\PC station [SIMATIC PC station]\HMI_RT_1 [WinCC RT Advanced]\User administration\Users\DisplayName
WEAK	HMI runtime	PID_PWM and PID_Output\PC station [SIMATIC PC station]\HMI_RT_1 [WinCC RT Advanced]\Text and graphic lists\Random Disturbance\Text_list_entry_3\Text
Web access - view only. Authorization for the use of WebNavigator and for client-server systems.	HMI comment	PID_PWM and PID_Output\PC station [SIMATIC PC station]\HMI_RT_1 [WinCC RT Advanced]\User administration\Web access - view only\Comment



PID_PWM and PID_Output / Languages & resources

Project graphics

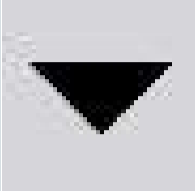
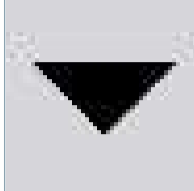
Down_Arrow

Standard graphic	English (United States)
	
▶ <i>Dithering mode</i>	
Same color	Same color
▶ <i>Smoothing</i>	
Disabled	Disabled

Home

Standard graphic	English (United States)
	
▶ <i>Dithering mode</i>	
Same color	Same color
▶ <i>Smoothing</i>	
Disabled	Disabled

Left_Arrow

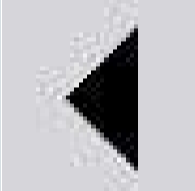
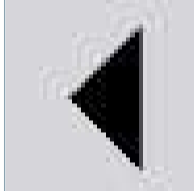
Standard graphic	English (United States)
	
▶ <i>Dithering mode</i>	
Same color	Same color
▶ <i>Smoothing</i>	
Disabled	Disabled

Right_Arrow

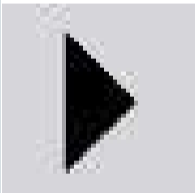
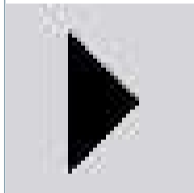
Standard graphic	English (United States)
	
▶ <i>Dithering mode</i>	
Same color	Same color
▶ <i>Smoothing</i>	
Disabled	Disabled

Up_Arrow

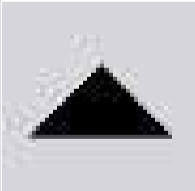
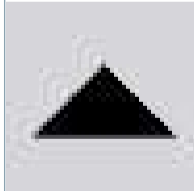
Standard graphic	English (United States)
	
▶ <i>Dithering mode</i>	
Same color	Same color
▶ <i>Smoothing</i>	
Disabled	Disabled