

# Instrumentation Tools

Totally Integrated Automation Portal		
--------------------------------------	--	--

## Open User Communication TCON-TCP blocks

Project							
<b>Name:</b>	Open User Communication TCON-TCP blocks	<b>Creation time:</b>	12/19/2023 8:07:36 AM	<b>Last change</b>	12/19/2023 11:47:14 AM	<b>Author:</b>	MahmoudSalama
<b>Last modified by:</b>	Mmuhamed	<b>Version:</b>					
<b>Comment:</b>							

Operating system	
Name	Description
Operating system	Microsoft Windows 10 Pro
Version of the operating system	6.3.9600.0
Operating system service pack	
Version of the Internet Explorer	11.3636.19041.0
Computer name	MMUHAMED-D1
User name	GULSANEGYPT\mmuhamed
Installation path of the TIA Portal	C:\Program Files\Siemens\Automation\Portal V16

Components		
Name	Version	Release
TIA Portal Project Server V16 - TIA Portal Project Server Single SetupPackage V16.0 (MUSERVERV16)	V16.0	V16.00.00.00_31.02.00.01
Siemens Totally Integrated Automation Portal V16 - SIMATIC S7-PLCSIM V16.0 (S7_PLCSIM_V16)	V16.0	V16.00.00.00_31.00.13.01
TIA Administrator - AWB Licensing Module V1.0 + SP2 (TIAADMIN)	V1.0 + SP2	V01.00.02.00_01.10.00.01
TIA Administrator - AWB Software Management V1.0 + SP2 (TIAADMIN)	V1.0 + SP2	V01.00.02.00_01.10.00.01
TIA Administrator - TIA UMC Agent Configurator Module V1.0 + SP2 (TIAADMIN)	V1.0 + SP2	V01.00.02.00_01.10.00.01
TIA Administrator - TIA Administrator V1.0 SP2 (TIAADMIN)	V1.0 + SP2	V01.00.02.00_01.10.00.01
Siemens Totally Integrated Automation Portal V16 - HM All Editions Single SetupPackage V16.0 (TIAP16)	V16.0	V16.00.00.00_31.02.00.01
Siemens Totally Integrated Automation Portal V16 - HM NoBasic Single SetupPackage V16.0 (TIAP16)	V16.0	V16.00.00.00_31.02.00.01
Siemens Totally Integrated Automation Portal V16 - Hardware Support Base Package 0 V16.0 (TIAP16)	V16.0	V16.00.00.00_27.01.00.01
Siemens Totally Integrated Automation Portal V16 - Multiuser Client Single SetupPackage V16.0 (TIAP16)	V16.0	V16.00.00.00_31.02.00.01
Siemens Totally Integrated Automation Portal V16 - Version Control Interface SetupPackage V16.0 (TIAP16)	V16.0	V16.00.00.00_31.02.00.01
Siemens Totally Integrated Automation Portal V16 - STEP 7 Safety Single SetupPackage V16.0 (TIAP16)	V16.0	V16.00.00.00_31.02.00.01
Siemens Totally Integrated Automation Portal V16 - SINAMICS Startdrive G110M, G120, G120C, G120D, G120P V16.0 (TIAP16)	V16.0	V16.00.00.00_20.00.00.04
Siemens Totally Integrated Automation Portal V16 - Startdrive Hardware Support Base Package 1 V16.0 (TIAP16)	V16.0	V16.00.00.00_20.00.00.04
Siemens Totally Integrated Automation Portal V16 - SINAMICS-STARTDRIVE-COMMON V16.0 (TIAP16)	V16.0	V16.00.00.00_20.00.00.04
Siemens Totally Integrated Automation Portal V16 - SINAMICS-STARTDRIVE-COMMON-OPENNESS V16.0 (TIAP16)	V16.0	V16.00.00.00_20.00.00.04
Siemens Totally Integrated Automation Portal V16 - SINAMICS-STARTDRIVE-COMMON-SAT V16.0 (TIAP16)	V16.0	V16.00.00.00_20.00.00.04
Siemens Totally Integrated Automation Portal V16 - SINAMICS Startdrive G130, G150, S120, S150, SINAMICS MV V16.0 (TIAP16)	V16.0	V16.00.00.00_20.00.00.04
Siemens Totally Integrated Automation Portal V16 - STEP 7 Single SetupPackage V16.0 (TIAP16)	V16.0	V16.00.00.00_31.02.00.01
Siemens Totally Integrated Automation Portal V16 - Hardware Support Base Package 02 V16.0 (TIAP16)	V16.0	V16.00.00.00_27.01.00.01
Siemens Totally Integrated Automation Portal V16 - Hardware Support Base Package 03 V16.0 (TIAP16)	V16.0	V16.00.00.00_27.01.00.01
Siemens Totally Integrated Automation Portal V16 - Hardware Support Base Package 04 V16.0 (TIAP16)	V16.0	V16.00.00.00_27.01.00.01
Siemens Totally Integrated Automation Portal V16 - Support Base Package TO-01 V16.0 (TIAP16)	V16.0	V16.00.00.00_27.01.00.01
Siemens Totally Integrated Automation Portal V16 - Support Base Package TO-02 V16.0 (TIAP16)	V16.0	V16.00.00.00_27.01.00.01
Siemens Totally Integrated Automation Portal V16 - Hardware Support Base Package WCF-01 V16.0 (TIAP16)	V16.0	V16.00.00.00_27.01.00.01
Siemens Totally Integrated Automation Portal V16 - TIACOMPCHCK Single SetupPackage V16.0 (TIAP16)	V16.0	V16.00.00.00_31.02.00.01
Siemens Totally Integrated Automation Portal V16 - Simatic Single SetupPackage V16.0 (TIAP16)	V16.0	V16.00.00.00_31.02.00.01
Siemens Totally Integrated Automation Portal V16 - WinCC Single SetupPackage V16.0 (TIAP16)	V16.0	V16.00.00.00_31.02.00.01
Siemens Totally Integrated Automation Portal V16 - Openness SetupPackage V16.0 (TIAP16)	V16.0	V16.00.00.00_31.02.00.01
Siemens Totally Integrated Automation Portal V16 - WinCC Transfer Mandatory Single SetupPackage V16.0 (TIAP16)	V16.0	V16.00.00.00_31.02.00.01
User Management Component - UserManagementComponentx64 V2.7 (UMC64)	V2.7	V02.07.00.00_04.06.00.07
WinCC Runtime Advanced V16.0 - HMIRTM Tagging Package 01 Single SetupPackage V16.0 (HMIRTM_V11)	V16.0	V16.00.00.00_31.02.00.01
WinCC Runtime Professional V16 - SIMATIC WinCC Runtime V16.0 (SCADA-RT_V11)	V16.0	V07.05.56.00_01.43.00.01
WinCC Runtime Professional V16 - OPCUA_Client V1.1 + SP1 (SCADA-RT_V11)	V1.1 + SP1	V01.01.01.00_01.11.00.01
WinCC Runtime Professional V16 - SCADA Simulation Single SetupPackage V16.0 (SCADA-RT_V11)	V16.0	V16.00.00.00_31.02.00.01

# Instrumentation Tools

Totally Integrated Automation Portal		
--------------------------------------	--	--

Name	Version	Release
Siemens Totally Integrated Automation Portal V16 - Simatic Single Setup-Package 32 Bit V16.0 (TIAP16)	V16.0	V16.00.00.00_31.02.00.01
Siemens Totally Integrated Automation Portal V16 - WinCC Single Setup-Package 32 Bit V16.0 (TIAP16)	V16.0	V16.00.00.00_31.02.00.01
SIMATIC HMI License Manager Panel Plugin (x64)	16.0.0.0	V16.00.00.00_31.02.00.01
SIMATIC WinCC Runtime Advanced Driver (x64)	16.0.0.0	V16.00.00.00_31.02.00.01
ETWEventCollector	16.0.0.0	V16.00.00.00_31.02.00.01
SIMATIC NCM FWL 64	5.6.0.3	K5.6.0.3_1.1.0.2
NCM GPRS 64	01.02.00.00	V1.2.0.0_2.1.0.1
SIMATIC PLCSIM 64	16.00.00	16.00.00.00_01.00.02.01
SIMATIC Device Drivers	9.2	09.02.04.00_01.04.00.05
TelemetryConnector	1.0.2.57	V01.00.02.57_01.00.00.01
Automation Software Updater	02.05.0300	V02.05.03.00_01.01.00.29
SIMATIC HMIProvider	7.0	K07.00.03.01_01.01.00.01
SIEMENS OPC	3.9	03.09.10.00_01.04.00.08
SIMATIC HMI ProSave	16.0.0.0	V16.00.00.00_31.02.00.01
SIMATIC HMI Symbol Library	16.0.0.0	V16.00.00.00_31.02.00.01
SIMATIC HMI Touch Input	16.0.0.0	V16.00.00.00_31.02.00.01
SIMATIC Runtime Interfaces	2.1	K02.01.00.03_01.01.00.01
SIMATIC Device Drivers WoW	29.2	29.02.04.00_01.04.00.05
SIMATIC Event Database	5.6	05.06.02.00_01.01.00.01
SeCon	2.6	V02.06.01.00_01.08.00.01
SIMATIC Station Observer	K7.3.1.0	V07.03.01.00_01.01.00.14
SIMATIC SCS	K7.5.2.2	V07.05.02.02_01.03.00.04
SIMATIC WinCC Common Archiving	V7.5.0.0	V07.05.56.00_01.43.00.01
WinCC Runtime Advanced Simulator	16.0.0.0	V16.00.00.00_31.02.00.01

Products		
Name	Version	Release
TIA Portal Project Server	V16.0	V16.00.00.00_31.02.00.01
SIMATIC S7-PLCSIM	V16.0	V16.00.00.00_31.00.13.01
TIA Administrator	V1.0	01.00.02.00_01.10.00.01
SINAMICS G110M, G120, G120C, G120D, G120P	V16.0	V16.00.00.00_20.00.00.04
SINAMICS G130, G150, S120, S150, SINAMICS MV, S210	V16.0	V16.00.00.00_20.00.00.04
SIMATIC STEP 7 Prof - STEP 7 Safety - WinCC Prof	V16.0	V16.00.00.00_31.02.00.01
User Management Component	V2.7	V02.07.00.00_00.00.00.00
SIMATIC WinCC Runtime Advanced Simulation	V16.0	V16.00.00.00_31.02.00.01
SIMATIC WinCC Runtime Professional Simulation	V16.0	V16.00.00.00_31.02.00.01
Automation License Manager	V6.0 + SP5 + Upd1	06.00.05.01_02.01.00.05
S7-PLCSIM	V5.4 + SP8	V05.04.08.01_01.24.00.01
SIMATIC ProSave	V16.0	V16.00.00.00_31.02.00.01
S7-PCT	V3.5 + SP1	K3.5.1.0_1.19.0.1

## Open User Communication TCON-TCP blocks

### PLC\_1 [CPU 1516-3 PN/DP]

PLC\_1

#### General\Project information

<b>Name</b>	PLC_1	<b>Author</b>	Mmuhamed	<b>Comment</b>	
<b>Rack</b>	0	<b>Slot</b>	1		

#### General\Catalog information

<b>Short designation</b>	CPU 1516-3 PN/DP	<b>Description</b>	CPU with display; work memory 1 MB code and 5 MB data; 10 ns bit operation time; 4-stage protection concept, technology functions: motion control, closed-loop control, counting and measuring; tracing; Runtime options; isochronous mode (central); for all PROFINET interfaces: transport protocol TCP/IP, secure Open User Communication, S7 communication, S7 routing, IP forwarding, Web server, DNS client, OPC UA: Server DA, Client DA, methods, companion specifications; 1st interface: PROFINET IO controller, supports RT/IRT, performance upgrade PROFINET V2.3, 2 ports, I-Device, MRP, MRPD, isochronous mode; 2nd interface: PROFINET IO controller, supports RT, I-Device; 3rd interface: PROFIBUS DP Master, S7 communication, isochronous mode, S7 routing; firmware V2.8	<b>Article number</b>	6ES7 516-3AN02-0AB0
<b>Firmware version</b>	V2.8				

#### General\Identification & Maintenance

<b>Plant designation</b>		<b>Location identifier</b>		<b>Installation date</b>	2023-12-19 08:09:18.843
<b>Additional information</b>					

#### General\Checksums

<b>Text lists</b>	FA 70 E8 75 1D 5A 8E 29	<b>Software</b>	77 B0 11 3E 4A 7C FB 04
-------------------	-------------------------	-----------------	-------------------------

#### Connection resources\

	Station resources - Reserved - Maximum	Station resources - Reserved - Configured	Station resources - Dynamic - Configured	Module resources - PLC_1 [CPU 1516-3 PN/DP] - Configured
Maximum number of resources:		10	118	128
	Maximum	Configured	Configured	Configured
PG communication:	4	-	-	-
HMI communication:	4	0	0	0
S7 communication:	0	-	0	0
Open user communication:	0	-	0	0
Web communication:	2	-	-	-
OPC UA client/server communication:	0	-	-	-
Other communication:	-	-	0	0
Total resources used:		0	0	0
Available resources:		10	118	128

#### Overview of addresses\Overview of addresses\Overview of addresses

<b>Inputs</b>	True	<b>Outputs</b>	True	<b>Address gaps</b>	False
<b>Slot</b>	True				

## Open User Communication TCON-TCP blocks / PLC\_1 [CPU 1516-3 PN/DP]

### Software units

This folder is empty.

## Open User Communication TCON-TCP blocks / PLC\_1 [CPU 1516-3 PN/DP] / Program blocks

### Main [OB1]

#### Main Properties

##### General

<b>Name</b>	Main	<b>Number</b>	1	<b>Type</b>	OB	<b>Language</b>	LAD
-------------	------	---------------	---	-------------	----	-----------------	-----

<b>Numbering</b>	Automatic
------------------	-----------

##### Information

<b>Title</b>	"Main Program Sweep (Cycle)"	<b>Author</b>		<b>Comment</b>		<b>Family</b>	
--------------	------------------------------	---------------	--	----------------	--	---------------	--

<b>Version</b>	0.1	<b>User-defined ID</b>	
----------------	-----	------------------------	--

Name	Data type	Default value
▼ Input		
Initial_Call	Bool	
Remanence	Bool	
Temp		
Constant		

#### Network 1:

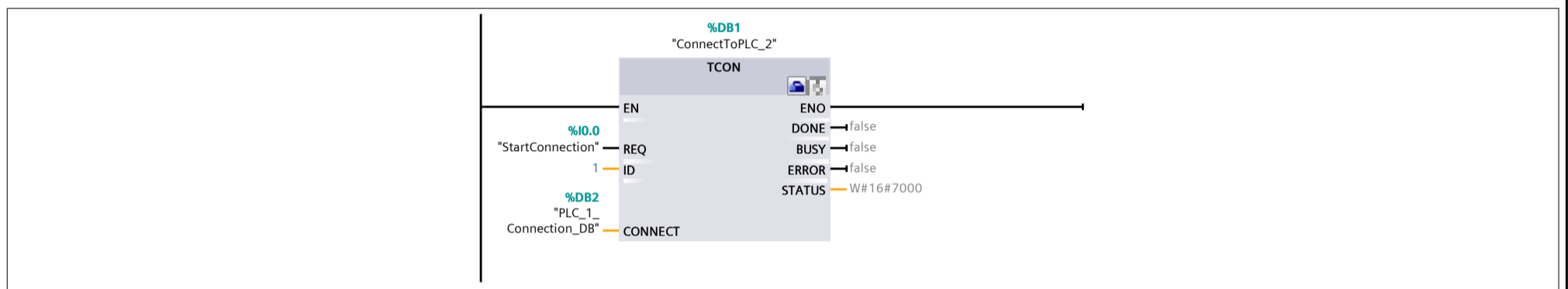

#### Network 2:

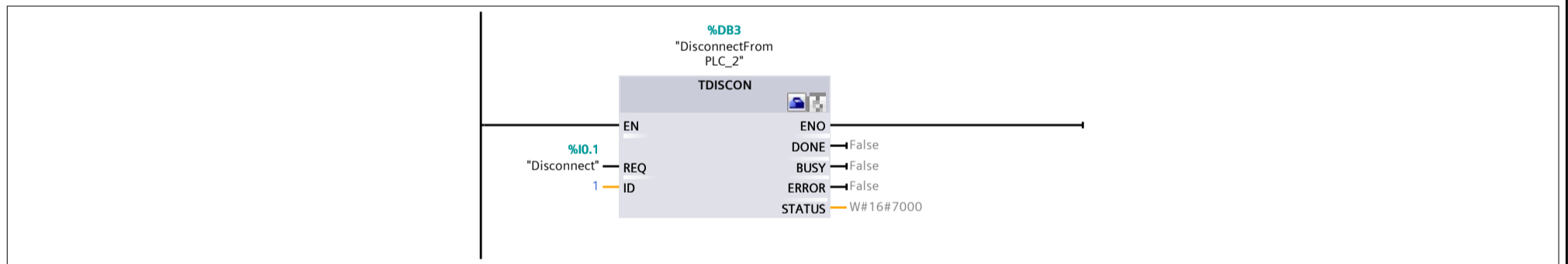

**Open User Communication TCON-TCP blocks / PLC\_1 [CPU 1516-3 PN/DP] / Program blocks / System blocks / Program resources**

**ConnectToPLC\_2 [DB1]**

**ConnectToPLC\_2 Properties**

**General**

<b>Name</b>	ConnectToPLC_2	<b>Number</b>	1	<b>Type</b>	DB	<b>Language</b>	DB
<b>Numbering</b>	Automatic						

**Information**

<b>Title</b>		<b>Author</b>	SIMATIC	<b>Comment</b>		<b>Family</b>	OUC
<b>Version</b>	1.0	<b>User-defined ID</b>	T_CON				

Name	Data type	Start value	Retain
▼ Input			
REQ	Bool	false	False
ID	CONN_OUC	16#0	False
▼ Output			
DONE	Bool	false	False
BUSY	Bool	false	False
ERROR	Bool	false	False
STATUS	Word	W#16#7000	False
▼ InOut			
CONNECT	Variant		False
Static			

## Open User Communication TCON-TCP blocks / PLC\_1 [CPU 1516-3 PN/DP] / Program blocks / System blocks / Program resources

### PLC\_1\_Connection\_DB [DB2]

#### PLC\_1\_Connection\_DB Properties

##### General

<b>Name</b>	PLC_1_Connection_DB	<b>Number</b>	2	<b>Type</b>	DB	<b>Language</b>	DB
<b>Numbering</b>	Automatic						

##### Information

<b>Title</b>		<b>Author</b>	SIMATIC	<b>Comment</b>		<b>Family</b>	MC7Plus
<b>Version</b>	1.0	<b>User-defined ID</b>	TC_IP_v4				

Name	Data type	Start value	Retain
▼ Static			
Interfaceld	HW_ANY	64	False
ID	CONN_OUC	1	False
ConnectionType	Byte	16#0B	False
ActiveEstablished	Bool	true	False
RemoteAddress	IP_V4		False
RemotePort	UInt	2000	False
LocalPort	UInt	0	False

Open User Communication TCON-TCP blocks / PLC\_1 [CPU 1516-3 PN/DP] / Program blocks / System blocks / Program resources

**DisconnectFromPLC\_2 [DB3]**

**DisconnectFromPLC\_2 Properties**

**General**

<b>Name</b>	DisconnectFromPLC_2	<b>Number</b>	3	<b>Type</b>	DB	<b>Language</b>	DB
<b>Numbering</b>	Automatic						

**Information**

<b>Title</b>		<b>Author</b>	SIMATIC	<b>Comment</b>		<b>Family</b>	OUC
<b>Version</b>	1.0	<b>User-defined ID</b>	T_DISCON				

Name	Data type	Start value	Retain
▼ Input			
REQ	Bool	False	False
ID	CONN_OUC	W#16#0	False
▼ Output			
DONE	Bool	False	False
BUSY	Bool	False	False
ERROR	Bool	False	False
STATUS	Word	W#16#7000	False
InOut			
Static			





## Open User Communication TCON-TCP blocks / PLC\_1 [CPU 1516-3 PN/DP]

### Technology objects

This folder is empty.



## Open User Communication TCON-TCP blocks / PLC\_1 [CPU 1516-3 PN/DP]

### PLC tags

PLC tags			
Icon	Name	Data type	Address
	Disconnect	Bool	%I0.1
	StartConnection	Bool	%I0.0

## Open User Communication TCON-TCP blocks / PLC\_1 [CPU 1516-3 PN/DP] / PLC tags

### Default tag table [51]

PLC tags			
Icon	Name	Data type	Address
	Disconnect	Bool	%I0.1
	StartConnection	Bool	%I0.0

## Open User Communication TCON-TCP blocks / PLC\_1 [CPU 1516-3 PN/DP] / PLC data types

### System data types

This folder is empty.

## Open User Communication TCON-TCP blocks / PLC\_1 [CPU 1516-3 PN/DP] / Watch and force tables

### Force table

Name	Address	Display format	Force value
------	---------	----------------	-------------

## Open User Communication TCON-TCP blocks / PLC\_1 [CPU 1516-3 PN/DP]

### Traces

Name

## Open User Communication TCON-TCP blocks / PLC\_1 [CPU 1516-3 PN/DP] / Traces

### Measurements

This folder is empty.

## Open User Communication TCON-TCP blocks / PLC\_1 [CPU 1516-3 PN/DP] / Traces

### Combined measurements

Name



## Open User Communication TCON-TCP blocks / PLC\_1 [CPU 1516-3 PN/DP] / OPC UA communication

### Server interfaces

This folder is empty.

## Open User Communication TCON-TCP blocks / PLC\_1 [CPU 1516-3 PN/DP] / OPC UA communication

### Client interfaces

This folder is empty.

## Open User Communication TCON-TCP blocks / PLC\_1 [CPU 1516-3 PN/DP] / PLC supervisions & alarms

### Supervisions

This folder is empty.

## Open User Communication TCON-TCP blocks / PLC\_1 [CPU 1516-3 PN/DP] / PLC supervisions & alarms

### PLC alarms

#### PLC alarms

























Name	Type	ID	Alarm text	Info text	Information only
------	------	----	------------	-----------	------------------

# Instrumentation Tools

























Totally Integrated Automation Portal

## Open User Communication TCON-TCP blocks / PLC\_1 [CPU 1516-3 PN/DP] / PLC supervisions & alarms

### System alarms

System alarms					
Name	Type	ID	Alarm text	Info text	Information only
 SDIAG_AL-CAT_SUBMO-DUL_MSG_0002	PLC alarm	1	Error: @1W%t#7W@ @5W%t#7W@ @6W%t#257K@ / @6W%t#258K@.@6W%t#259K@ @6W%t#262K@ @6W%t#263K@	Short name: @6W%t#260K@ Order number: @6W%t#265K@	True
 SDIAG_AL-CAT_MOD-UL_MSG_0003	PLC alarm	2	Error: @1W%t#7W@ @5W%t#7W@ @6W%t#257K@ / @6W%t#258K@ @6W%t#262K@ @6W%t#263K@	Short name: @6W%t#260K@ Order number: @6W%t#265K@	True
 SDIAG_AL-CAT_RACK_MSG_0004	PLC alarm	3	Error: @1W%t#7W@ @5W%t#7W@ @6W%t#257K@ @6W%t#262K@ @6W%t#263K@	Short name: @6W%t#260K@ Order number: @6W%t#265K@	True
 SDIAG_AL-CAT_DE-VICE_MSG_0005	PLC alarm	4	Error: @1W%t#7W@ @5W%t#7W@ @6W%t#257K@ @6W%t#262K@ @6W%t#263K@ @8W%t#7W@	Short name: @6W%t#260K@ Order number: @6W%t#265K@	True
 SDIAG_AL-CAT_IOSYS-TEM_MSG_0006	PLC alarm	5	Error: @1W%t#7W@ @5W%t#7W@ @6W%t#276K@ @6W%t#262K@ @6W%t#263K@ @8W%t#7W@	Short name: @6W%t#260K@ Order number: @6W%t#265K@	True
 SDIAG_AL-CAT_CPU_OST_MSG_000D	PLC alarm	6	CPU status message: @1W%t#7W@ @5W%t#7W@ @6W%t#257K@ / @6W%t#258K@ @6W%t#262K@ @6W%t#263K@ @8W%t#7W@	Short name: @6W%t#260K@ Order number: @6W%t#265K@	True
 SDIAG_AL-CAT_CPU_IN-FO_MSG_000F	PLC alarm	7	CPU info: @1W%t#7W@ @5W%t#7W@ @6W%t#257K@ / @6W%t#258K@ @6W%t#262K@ @6W%t#263K@ @8W%t#7W@	Short name: @6W%t#260K@ Order number: @6W%t#265K@	True
 SDIAG_AL-CAT_CPU_ERR_M SG_0010	PLC alarm	8	CPU error: @1W%t#7W@ @5W%t#7W@ @6W%t#257K@ / @6W%t#258K@ @6W%t#262K@ @6W%t#263K@ @8W%t#7W@	Short name: @6W%t#260K@ Order number: @6W%t#265K@	True
 SDIAG_AL-CAT_CPU_MD_M SG_0011	PLC alarm	9	CPU maintenance demanded: @1W%t#7W@ @6W%t#257K@ / @5W%t#7W@ @6W%t#258K@ @6W%t#262K@ @6W%t#263K@ @8W%t#7W@	Short name: @6W%t#260K@ Order number: @6W%t#265K@	True
 SDIAG_AL-CAT_CPU_MR_M SG1_0012	PLC alarm	10	CPU maintenance required: @1W%t#7W@ @6W%t#257K@ / @5W%t#7W@ @6W%t#258K@ @6W%t#262K@ @6W%t#263K@ @8W%t#7W@	Short name: @6W%t#260K@ Order number: @6W%t#265K@	True
 SDIAG_AL-CAT_CPU_TMPER R_MSG_0013	PLC alarm	11	Temporary CPU error: @1W%t#7W@ @5W%t#7W@ @6W%t#257K@ / @6W%t#258K@ @6W%t#262K@ @6W%t#263K@ @8W%t#7W@	Short name: @6W%t#260K@ Order number: @6W%t#265K@	True
 SDIAG_AL-CAT_CH_ERR_MS G_0015	PLC alarm	12	Error: @1W%t#7W@ on @8W%t#280K@ @6W%t#257K@ / @6W%t#258K@.@6W%t#259K@ @6W%t#262K@ @6W%t#263K@	Short name: @6W%t#260K@ Order number: @6W%t#265K@	True
 SDIAG_AL-CAT_ECH_ERR_M SG_0016	PLC alarm	13	Error: @1W%t#7W@ - @5W%t#7W@ on @8W%t#280K@ @6W%t#257K@ / @6W%t#258K@.@6W%t#259K@ @6W%t#262K@ @6W%t#263K@	Short name: @6W%t#260K@ Order number: @6W%t#265K@	True
 SDIAG_AL-CAT_CH_MD_MS G_0018	PLC alarm	14	Maintenance demanded:@1W%t#7W@ on @8W%t#280K@ @6W%t#257K@ / @6W%t#258K@.@6W%t#259K@ @6W%t#262K@ @6W%t#263K@	Short name: @6W%t#260K@ Order number: @6W%t#265K@	True
 SDIAG_AL-CAT_ECH_MD_M SG_0019	PLC alarm	15	Maintenance demanded:@1W%t#7W@ - @5W%t#7W@ on @8W%t#280K@ @6W%t#257K@ / @6W%t#258K@.@6W%t#259K@ @6W%t#262K@ @6W%t#263K@	Short name: @6W%t#260K@ Order number: @6W%t#265K@	True
 SDIAG_AL-CAT_CH_MR_MS G_001B	PLC alarm	16	Maintenance required:@1W%t#7W@ on @8W%t#280K@ @6W%t#257K@ / @6W%t#258K@.@6W%t#259K@ @6W%t#262K@ @6W%t#263K@	Short name: @6W%t#260K@ Order number: @6W%t#265K@	True
 SDIAG_AL-CAT_ECH_MR_M SG_001C	PLC alarm	17	Maintenance required:@1W%t#7W@ - @5W%t#7W@ on @8W%t#280K@ @6W%t#257K@ / @6W%t#258K@.@6W%t#259K@ @6W%t#262K@ @6W%t#263K@	Short name: @6W%t#260K@ Order number: @6W%t#265K@	True
 SDIAG_AL-CAT_SUB_ERR_M SG_001E	PLC alarm	18	Error: @1W%t#7W@ @6W%t#257K@ / @6W%t#258K@.@6W%t#259K@ @6W%t#262K@ @6W%t#263K@	Short name: @6W%t#260K@ Order number: @6W%t#265K@	True
 SDIAG_AL-CAT_ESUB_ERR_M SG_001F	PLC alarm	19	Error: @1W%t#7W@ - @5W%t#7W@ @6W%t#257K@ / @6W%t#258K@.@6W%t#259K@ @6W%t#262K@ @6W%t#263K@	Short name: @6W%t#260K@ Order number: @6W%t#265K@	True
 SDIAG_AL-CAT_SUB_MD_M SG_0021	PLC alarm	20	Maintenance demanded: @1W%t#7W@ @6W%t#257K@ / @6W%t#258K@.@6W%t#259K@ @6W%t#262K@ @6W%t#263K@	Short name: @6W%t#260K@ Order number: @6W%t#265K@	True
 SDIAG_AL-CAT_ESUB_MD_M SG_0022	PLC alarm	21	Maintenance demanded: @1W%t#7W@ - @5W%t#7W@ @6W%t#257K@ / @6W%t#258K@.@6W%t#259K@ @6W%t#262K@ @6W%t#263K@	Short name: @6W%t#260K@ Order number: @6W%t#265K@	True
 SDIAG_AL-CAT_SUB_MR_M SG_0024	PLC alarm	22	Maintenance required: @1W%t#7W@ @6W%t#257K@ / @6W%t#258K@.@6W%t#259K@ @6W%t#262K@ @6W%t#263K@	Short name: @6W%t#260K@ Order number: @6W%t#265K@	True
 SDIAG_AL-CAT_ESUB_MR_M SG_0025	PLC alarm	23	Maintenance required: @1W%t#7W@ - @5W%t#7W@ @6W%t#257K@ / @6W%t#258K@.@6W%t#259K@ @6W%t#262K@ @6W%t#263K@	Short name: @6W%t#260K@ Order number: @6W%t#265K@	True
 SDIAG_AL-CAT_CONFIG_IN-FO_0028	PLC alarm	24	Info: @1W%t#7W@ - @5W%t#7W@ @6W%t#257K@ @6W%t#262K@ @6W%t#263K@ @8W%t#7W@	Short name: @6W%t#260K@ Order number: @6W%t#265K@	True
 SDIAG_AL-CAT_CONFIG_RE-PORT_0029	PLC alarm	25	Info: @1W%t#7W@ - @5W%t#7W@ @6W%t#257K@ / @6W%t#258K@ @6W%t#262K@ @6W%t#263K@	Short name: @6W%t#260K@ Order number: @6W%t#265K@	True
 SDIAG_AL-CAT_SE-CU_EV_MSG_005E	PLC alarm	26	Security event: @1W%t#7W@ @5W%t#7W@ @6W%t#258K@ @6W%t#262K@ @6W%t#263K@ @8W%t#7W@	Short name: @6W%t#260K@ Order number: @6W%t#265K@	True
 SDIAG_AL-CAT_SE-CU_EV_IN-FO_005F	PLC alarm	27	Security information: @1W%t#7W@ @5W%t#7W@ @6W%t#258K@ @6W%t#262K@ @6W%t#263K@ @8W%t#7W@	Short name: @6W%t#260K@ Order number: @6W%t#265K@	True

# Instrumentation Tools

Totally Integrated Automation Portal						
Name	Type	ID	Alarm text	Info text	Information only	
 SDIAG_AL-CAT_USER_MSG_0080	PLC alarm	28	User message: @1W%t#2W@	Short name: @6W%t#260K@ Order number: @6W%t#265K@	True	
 SDIAG_AL-CAT_PLC_MSG_0OFF	PLC alarm	29	PLC notification: @1W%t#7W@ @5W%t#7W@ @6W%t#256K@ @6W%t#262K@ @6W%t#263K@	Short name: @6W%t#260K@ Order number: @6W%t#265K@	True	
 SDIAG_AL-CAT_SUBMO-DUL_MSG_0102	PLC alarm	30	Error: @1W%t#7W@ @5W%t#7W@ @6W%t#257K@ / @6W%t#258K@.@6W%t#259K@ @6W%t#262K@ @6W%t#263K@	Short name: @6W%t#260K@ Order number: @6W%t#265K@	False	
 SDIAG_AL-CAT_MOD-UL_MSG_0103	PLC alarm	31	Error: @1W%t#7W@ @5W%t#7W@ @6W%t#257K@ / @6W%t#258K@ @6W%t#262K@ @6W%t#263K@	Short name: @6W%t#260K@ Order number: @6W%t#265K@	False	
 SDIAG_AL-CAT_RACK_MSG_0104	PLC alarm	32	Error: @1W%t#7W@ @5W%t#7W@ @6W%t#257K@ @6W%t#262K@ @6W%t#263K@	Short name: @6W%t#260K@ Order number: @6W%t#265K@	False	
 SDIAG_AL-CAT_DE-VICE_MSG_0105	PLC alarm	33	Error: @1W%t#7W@ @5W%t#7W@ @6W%t#257K@ @6W%t#262K@ @6W%t#263K@ @8W%t#7W@	Short name: @6W%t#260K@ Order number: @6W%t#265K@	False	
 SDIAG_AL-CAT_IOSYS-TEM_MSG_0106	PLC alarm	34	Error: @1W%t#7W@ @5W%t#7W@ @6W%t#276K@ @6W%t#262K@ @6W%t#263K@ @8W%t#7W@	Short name: @6W%t#260K@ Order number: @6W%t#265K@	False	
 SDIAG_AL-CAT_CPU_OST_MSG_010D	PLC alarm	35	CPU status message: @1W%t#7W@ @5W%t#7W@ @6W%t#257K@ / @6W%t#258K@ @6W%t#262K@ @6W%t#263K@ @8W%t#7W@	Short name: @6W%t#260K@ Order number: @6W%t#265K@	False	
 SDIAG_AL-CAT_CPU_ERR_M SG_0110	PLC alarm	36	CPU error: @1W%t#7W@ @5W%t#7W@ @6W%t#257K@ / @6W%t#258K@ @6W%t#262K@ @6W%t#263K@ @8W%t#7W@	Short name: @6W%t#260K@ Order number: @6W%t#265K@	False	
 SDIAG_AL-CAT_CPU_MD_M SG_0111	PLC alarm	37	CPU maintenance demanded: @1W%t#7W@ @6W%t#257K@ / @5W%t#7W@ @6W%t#258K@ @6W%t#262K@ @6W%t#263K@ @8W%t#7W@	Short name: @6W%t#260K@ Order number: @6W%t#265K@	False	
 SDIAG_AL-CAT_CPU_MR_M SG1_0112	PLC alarm	38	CPU maintenance required: @1W%t#7W@ @6W%t#257K@ / @5W%t#7W@ @6W%t#258K@ @6W%t#262K@ @6W%t#263K@ @8W%t#7W@	Short name: @6W%t#260K@ Order number: @6W%t#265K@	False	
 SDIAG_AL-CAT_CH_ERR_M SG_0115	PLC alarm	39	Error: @1W%t#7W@ on @8W%t#280K@ @6W%t#257K@ / @6W%t#258K@.@6W%t#259K@ @6W%t#262K@ @6W%t#263K@	Short name: @6W%t#260K@ Order number: @6W%t#265K@	False	
 SDIAG_AL-CAT_ECH_ERR_M SG_0116	PLC alarm	40	Error: @1W%t#7W@ - @5W%t#7W@ on @8W%t#280K@ @6W%t#257K@ / @6W%t#258K@.@6W%t#259K@ @6W%t#262K@ @6W%t#263K@	Short name: @6W%t#260K@ Order number: @6W%t#265K@	False	
 SDIAG_AL-CAT_CH_MD_M SG_0118	PLC alarm	41	Maintenance demanded: @1W%t#7W@ on @8W%t#280K@ @6W%t#257K@ / @6W%t#258K@.@6W%t#259K@ @6W%t#262K@ @6W%t#263K@	Short name: @6W%t#260K@ Order number: @6W%t#265K@	False	
 SDIAG_AL-CAT_ECH_MD_M SG_0119	PLC alarm	42	Maintenance demanded: @1W%t#7W@ - @5W%t#7W@ on @8W%t#280K@ @6W%t#257K@ / @6W%t#258K@.@6W%t#259K@ @6W%t#262K@ @6W%t#263K@	Short name: @6W%t#260K@ Order number: @6W%t#265K@	False	
 SDIAG_AL-CAT_CH_MR_M SG_011B	PLC alarm	43	Maintenance required: @1W%t#7W@ on @8W%t#280K@ @6W%t#257K@ / @6W%t#258K@.@6W%t#259K@ @6W%t#262K@ @6W%t#263K@	Short name: @6W%t#260K@ Order number: @6W%t#265K@	False	
 SDIAG_AL-CAT_ECH_MR_M SG_011C	PLC alarm	44	Maintenance required: @1W%t#7W@ - @5W%t#7W@ on @8W%t#280K@ @6W%t#257K@ / @6W%t#258K@.@6W%t#259K@ @6W%t#262K@ @6W%t#263K@	Short name: @6W%t#260K@ Order number: @6W%t#265K@	False	
 SDIAG_AL-CAT_SUB_ERR_M SG_011E	PLC alarm	45	Error: @1W%t#7W@ @6W%t#257K@ / @6W%t#258K@.@6W%t#259K@ @6W%t#262K@ @6W%t#263K@	Short name: @6W%t#260K@ Order number: @6W%t#265K@	False	
 SDIAG_AL-CAT_ESUB_ERR_M SG_011F	PLC alarm	46	Error: @1W%t#7W@ - @5W%t#7W@ @6W%t#257K@ / @6W%t#258K@.@6W%t#259K@ @6W%t#262K@ @6W%t#263K@	Short name: @6W%t#260K@ Order number: @6W%t#265K@	False	
 SDIAG_AL-CAT_SUB_MD_M SG_0121	PLC alarm	47	Maintenance demanded: @1W%t#7W@ @6W%t#257K@ / @6W%t#258K@.@6W%t#259K@ @6W%t#262K@ @6W%t#263K@	Short name: @6W%t#260K@ Order number: @6W%t#265K@	False	
 SDIAG_AL-CAT_ESUB_MD_M SG_0122	PLC alarm	48	Maintenance demanded: @1W%t#7W@ - @5W%t#7W@ @6W%t#257K@ / @6W%t#258K@.@6W%t#259K@ @6W%t#262K@ @6W%t#263K@	Short name: @6W%t#260K@ Order number: @6W%t#265K@	False	
 SDIAG_AL-CAT_SUB_MR_M SG_0124	PLC alarm	49	Maintenance required: @1W%t#7W@ @6W%t#257K@ / @6W%t#258K@.@6W%t#259K@ @6W%t#262K@ @6W%t#263K@	Short name: @6W%t#260K@ Order number: @6W%t#265K@	False	
 SDIAG_AL-CAT_ESUB_MR_M SG_0125	PLC alarm	50	Maintenance required: @1W%t#7W@ - @5W%t#7W@ @6W%t#257K@ / @6W%t#258K@.@6W%t#259K@ @6W%t#262K@ @6W%t#263K@	Short name: @6W%t#260K@ Order number: @6W%t#265K@	False	
 SDIAG_AL-CAT_CONFIG_IN-FO_0128	PLC alarm	51	Info: @1W%t#7W@ - @5W%t#7W@ @6W%t#257K@ @6W%t#262K@ @6W%t#263K@ @8W%t#7W@	Short name: @6W%t#260K@ Order number: @6W%t#265K@	False	
 SDIAG_AL-CAT_PLC_MSG_01FF	PLC alarm	52	PLC notification: @1W%t#7W@ @5W%t#7W@ @6W%t#256K@ @6W%t#262K@ @6W%t#263K@	Short name: @6W%t#260K@ Order number: @6W%t#265K@	False	

## Open User Communication TCON-TCP blocks / PLC\_1 [CPU 1516-3 PN/DP]

### PLC alarm text lists

This folder is empty.

## Open User Communication TCON-TCP blocks / PLC\_1 [CPU 1516-3 PN/DP] / Local modules

### PLC\_1 [CPU 1516-3 PN/DP]

#### PLC\_1

##### General\Project information

<b>Name</b>	PLC_1	<b>Author</b>	Mmuhamed	<b>Comment</b>	
<b>Rack</b>	0	<b>Slot</b>	1		

##### General\Catalog information

<b>Short designation</b>	CPU 1516-3 PN/DP	<b>Description</b>	CPU with display; work memory 1 MB code and 5 MB data; 10 ns bit operation time; 4-stage protection concept, technology functions: motion control, closed-loop control, counting and measuring; tracing; Runtime options; isochronous mode (central); for all PROFINET interfaces: transport protocol TCP/IP, secure Open User Communication, S7 communication, S7 routing, IP forwarding, Web server, DNS client, OPC UA: Server DA, Client DA, methods, companion specifications; 1st interface: PROFINET IO controller, supports RT/IRT, performance upgrade PROFINET V2.3, 2 ports, I-Device, MRP, MRPD, isochronous mode; 2nd interface: PROFINET IO controller, supports RT, I-Device; 3rd interface: PROFIBUS DP Master, S7 communication, isochronous mode, S7 routing; firmware V2.8	<b>Article number</b>	6ES7 516-3AN02-0AB0
<b>Firmware version</b>	V2.8				

##### General\Identification & Maintenance

<b>Plant designation</b>		<b>Location identifier</b>		<b>Installation date</b>	2023-12-19 08:09:18.843
<b>Additional information</b>					

##### General\Checksums

<b>Text lists</b>	FA 70 E8 75 1D 5A 8E 29	<b>Software</b>	77 B0 11 3E 4A 7C FB 04
-------------------	-------------------------	-----------------	-------------------------

##### Connection resources\

	Station resources - Reserved - Maximum	Station resources - Reserved - Configured	Station resources - Dynamic - Configured	Module resources - PLC_1 [CPU 1516-3 PN/DP] - Configured
Maximum number of resources:		10	118	128
	Maximum	Configured	Configured	Configured
PG communication:	4	-	-	-
HMI communication:	4	0	0	0
S7 communication:	0	-	0	0
Open user communication:	0	-	0	0
Web communication:	2	-	-	-
OPC UA client/server communication:	0	-	-	-
Other communication:	-	-	0	0
Total resources used:		0	0	0
Available resources:		10	118	128

##### Overview of addresses\Overview of addresses\Overview of addresses

<b>Inputs</b>	True	<b>Outputs</b>	True	<b>Address gaps</b>	False
<b>Slot</b>	True				



## Open User Communication TCON-TCP blocks

### PLC\_2 [CPU 1516-3 PN/DP]

PLC\_2

#### General\Project information

<b>Name</b>	PLC_2	<b>Author</b>	Mmuhamed	<b>Comment</b>	
<b>Rack</b>	0	<b>Slot</b>	1		

#### General\Catalog information

<b>Short designation</b>	CPU 1516-3 PN/DP	<b>Description</b>	CPU with display; work memory 1 MB code and 5 MB data; 10 ns bit operation time; 4-stage protection concept, technology functions: motion control, closed-loop control, counting and measuring; tracing; Runtime options; isochronous mode (central); for all PROFINET interfaces: transport protocol TCP/IP, secure Open User Communication, S7 communication, S7 routing, IP forwarding, Web server, DNS client, OPC UA: Server DA, Client DA, methods, companion specifications; 1st interface: PROFINET IO controller, supports RT/IRT, performance upgrade PROFINET V2.3, 2 ports, I-Device, MRP, MRPD, isochronous mode; 2nd interface: PROFINET IO controller, supports RT, I-Device; 3rd interface: PROFIBUS DP Master, S7 communication, isochronous mode, S7 routing; firmware V2.8	<b>Article number</b>	6ES7 516-3AN02-0AB0
<b>Firmware version</b>	V2.8				

#### General\Identification & Maintenance

<b>Plant designation</b>		<b>Location identifier</b>		<b>Installation date</b>	2023-12-19 08:24:18.917
<b>Additional information</b>					

#### General\Checksums

<b>Text lists</b>	FA 70 E8 75 1D 5A 8E 29	<b>Software</b>	51 01 8F A2 0D 18 25 FD
-------------------	-------------------------	-----------------	-------------------------

#### Connection resources\

	Station resources - Reserved - Maximum	Station resources - Reserved - Configured	Station resources - Dynamic - Configured	Module resources - PLC_2 [CPU 1516-3 PN/DP] - Configured
Maximum number of resources:		10	118	128
	Maximum	Configured	Configured	Configured
PG communication:	4	-	-	-
HMI communication:	4	0	0	0
S7 communication:	0	-	0	0
Open user communication:	0	-	0	0
Web communication:	2	-	-	-
OPC UA client/server communication:	0	-	-	-
Other communication:	-	-	0	0
Total resources used:		0	0	0
Available resources:		10	118	128

#### Overview of addresses\Overview of addresses\Overview of addresses

<b>Inputs</b>	True	<b>Outputs</b>	True	<b>Address gaps</b>	False
<b>Slot</b>	True				

## Open User Communication TCON-TCP blocks / PLC\_2 [CPU 1516-3 PN/DP]

### Software units

This folder is empty.

## Open User Communication TCON-TCP blocks / PLC\_2 [CPU 1516-3 PN/DP] / Program blocks

### Main [OB1]

#### Main Properties

##### General

<b>Name</b>	Main	<b>Number</b>	1	<b>Type</b>	OB	<b>Language</b>	LAD
-------------	------	---------------	---	-------------	----	-----------------	-----

<b>Numbering</b>	Automatic
------------------	-----------

##### Information

<b>Title</b>	"Main Program Sweep (Cycle)"	<b>Author</b>		<b>Comment</b>		<b>Family</b>	
--------------	------------------------------	---------------	--	----------------	--	---------------	--

<b>Version</b>	0.1	<b>User-defined ID</b>	
----------------	-----	------------------------	--

Name	Data type	Default value
▼ Input		
Initial_Call	Bool	
Remanence	Bool	
Temp		
Constant		

#### Network 1:

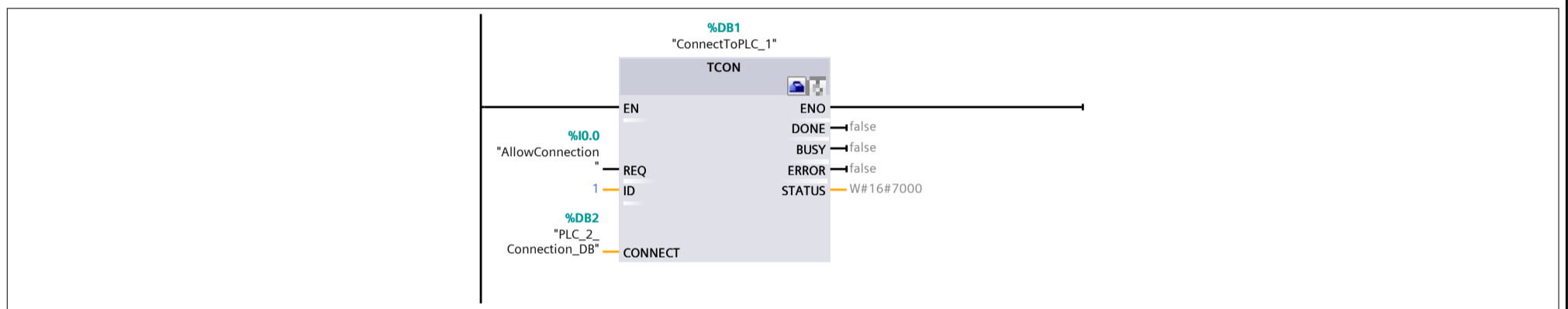

#### Network 2:

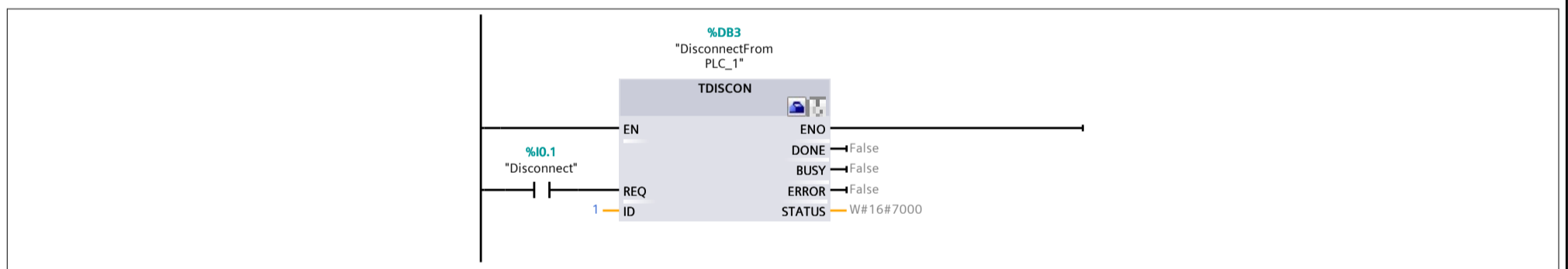

#### Network 3:

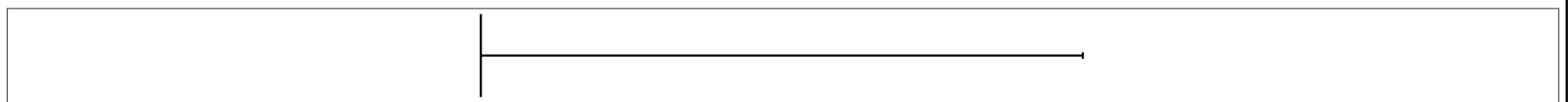

Open User Communication TCON-TCP blocks / PLC\_2 [CPU 1516-3 PN/DP] / Program blocks / System blocks / Program resources

**ConnectToPLC\_1 [DB1]**

**ConnectToPLC\_1 Properties**

**General**

<b>Name</b>	ConnectToPLC_1	<b>Number</b>	1	<b>Type</b>	DB	<b>Language</b>	DB
<b>Numbering</b>	Automatic						

**Information**

<b>Title</b>		<b>Author</b>	SIMATIC	<b>Comment</b>		<b>Family</b>	OUC
<b>Version</b>	1.0	<b>User-defined ID</b>	T_CON				

Name	Data type	Start value	Retain
▼ Input			
REQ	Bool	false	False
ID	CONN_OUC	16#0	False
▼ Output			
DONE	Bool	false	False
BUSY	Bool	false	False
ERROR	Bool	false	False
STATUS	Word	W#16#7000	False
▼ InOut			
CONNECT	Variant		False
Static			

## Open User Communication TCON-TCP blocks / PLC\_2 [CPU 1516-3 PN/DP] / Program blocks / System blocks / Program resources

### PLC\_2\_Connection\_DB [DB2]

#### PLC\_2\_Connection\_DB Properties

##### General

<b>Name</b>	PLC_2_Connection_DB	<b>Number</b>	2	<b>Type</b>	DB	<b>Language</b>	DB
<b>Numbering</b>	Automatic						

##### Information

<b>Title</b>		<b>Author</b>	SIMATIC	<b>Comment</b>		<b>Family</b>	MC7Plus
<b>Version</b>	1.0	<b>User-defined ID</b>	TC_IP_v4				

Name	Data type	Start value	Retain
▼ Static			
Interfaceld	HW_ANY	64	False
ID	CONN_OUC	1	False
ConnectionType	Byte	16#0B	False
ActiveEstablished	Bool	false	False
RemoteAddress	IP_V4		False
RemotePort	UInt	0	False
LocalPort	UInt	2000	False

Open User Communication TCON-TCP blocks / PLC\_2 [CPU 1516-3 PN/DP] / Program blocks / System blocks / Program resources

**DisconnectFromPLC\_1 [DB3]**

**DisconnectFromPLC\_1 Properties**

**General**

<b>Name</b>	DisconnectFromPLC_1	<b>Number</b>	3	<b>Type</b>	DB	<b>Language</b>	DB
<b>Numbering</b>	Automatic						

**Information**

<b>Title</b>		<b>Author</b>	SIMATIC	<b>Comment</b>		<b>Family</b>	OUC
<b>Version</b>	1.0	<b>User-defined ID</b>	T_DISCON				

Name	Data type	Start value	Retain
▼ Input			
REQ	Bool	False	False
ID	CONN_OUC	W#16#0	False
▼ Output			
DONE	Bool	False	False
BUSY	Bool	False	False
ERROR	Bool	False	False
STATUS	Word	W#16#7000	False
InOut			
Static			



## Open User Communication TCON-TCP blocks / PLC\_2 [CPU 1516-3 PN/DP]

### Technology objects

This folder is empty.

## Open User Communication TCON-TCP blocks / PLC\_2 [CPU 1516-3 PN/DP]

### PLC tags

PLC tags			
Icon	Name	Data type	Address
	AllowConnection	Bool	%I0.0
	Disconnect	Bool	%I0.1



## Open User Communication TCON-TCP blocks / PLC\_2 [CPU 1516-3 PN/DP] / PLC tags

### Default tag table [51]

#### PLC tags

Icon	Name	Data type	Address
	AllowConnection	Bool	%I0.0
	Disconnect	Bool	%I0.1

## Open User Communication TCON-TCP blocks / PLC\_2 [CPU 1516-3 PN/DP] / PLC data types

### System data types

This folder is empty.

## Open User Communication TCON-TCP blocks / PLC\_2 [CPU 1516-3 PN/DP] / Watch and force tables

### Force table

Name	Address	Display format	Force value
------	---------	----------------	-------------

## Open User Communication TCON-TCP blocks / PLC\_2 [CPU 1516-3 PN/DP]

### Traces

Name

## Open User Communication TCON-TCP blocks / PLC\_2 [CPU 1516-3 PN/DP] / Traces

### Measurements

This folder is empty.

## Open User Communication TCON-TCP blocks / PLC\_2 [CPU 1516-3 PN/DP] / Traces

### Combined measurements

Name

## Open User Communication TCON-TCP blocks / PLC\_2 [CPU 1516-3 PN/DP] / OPC UA communication

### Server interfaces

This folder is empty.

## Open User Communication TCON-TCP blocks / PLC\_2 [CPU 1516-3 PN/DP] / OPC UA communication

### Client interfaces

This folder is empty.



## Open User Communication TCON-TCP blocks / PLC\_2 [CPU 1516-3 PN/DP] / PLC supervisions & alarms

### Supervisions

This folder is empty.

## Open User Communication TCON-TCP blocks / PLC\_2 [CPU 1516-3 PN/DP] / PLC supervisions & alarms

























### PLC alarms

#### PLC alarms

























Name	Type	ID	Alarm text	Info text	Information only
------	------	----	------------	-----------	------------------

## Open User Communication TCON-TCP blocks / PLC\_2 [CPU 1516-3 PN/DP] / PLC supervisions & alarms

### System alarms

System alarms					
Name	Type	ID	Alarm text	Info text	Information only
 SDIAG_AL-CAT_SUBMO-DUL_MSG_0002	PLC alarm	1	Error: @1W%t#7W@ @5W%t#7W@ @6W%t#257K@ / @6W%t#258K@.@6W%t#259K@ @6W%t#262K@ @6W%t#263K@	Short name: @6W%t#260K@ Order number: @6W%t#265K@	True
 SDIAG_AL-CAT_MOD-UL_MSG_0003	PLC alarm	2	Error: @1W%t#7W@ @5W%t#7W@ @6W%t#257K@ / @6W%t#258K@ @6W%t#262K@ @6W%t#263K@	Short name: @6W%t#260K@ Order number: @6W%t#265K@	True
 SDIAG_AL-CAT_RACK_MSG_0004	PLC alarm	3	Error: @1W%t#7W@ @5W%t#7W@ @6W%t#257K@ @6W%t#262K@ @6W%t#263K@	Short name: @6W%t#260K@ Order number: @6W%t#265K@	True
 SDIAG_AL-CAT_DE-VICE_MSG_0005	PLC alarm	4	Error: @1W%t#7W@ @5W%t#7W@ @6W%t#257K@ @6W%t#262K@ @6W%t#263K@ @8W%t#7W@	Short name: @6W%t#260K@ Order number: @6W%t#265K@	True
 SDIAG_AL-CAT_IOSYS-TEM_MSG_0006	PLC alarm	5	Error: @1W%t#7W@ @5W%t#7W@ @6W%t#276K@ @6W%t#262K@ @6W%t#263K@ @8W%t#7W@	Short name: @6W%t#260K@ Order number: @6W%t#265K@	True
 SDIAG_AL-CAT_CPU_OST_MSG_000D	PLC alarm	6	CPU status message: @1W%t#7W@ @5W%t#7W@ @6W%t#257K@ / @6W%t#258K@ @6W%t#262K@ @6W%t#263K@ @8W%t#7W@	Short name: @6W%t#260K@ Order number: @6W%t#265K@	True
 SDIAG_AL-CAT_CPU_IN-FO_MSG_000F	PLC alarm	7	CPU info: @1W%t#7W@ @5W%t#7W@ @6W%t#257K@ / @6W%t#258K@ @6W%t#262K@ @6W%t#263K@ @8W%t#7W@	Short name: @6W%t#260K@ Order number: @6W%t#265K@	True
 SDIAG_AL-CAT_CPU_ERR_M SG_0010	PLC alarm	8	CPU error: @1W%t#7W@ @5W%t#7W@ @6W%t#257K@ / @6W%t#258K@ @6W%t#262K@ @6W%t#263K@ @8W%t#7W@	Short name: @6W%t#260K@ Order number: @6W%t#265K@	True
 SDIAG_AL-CAT_CPU_MD_M SG_0011	PLC alarm	9	CPU maintenance demanded: @1W%t#7W@ @6W%t#257K@ / @5W%t#7W@ @6W%t#258K@ @6W%t#262K@ @6W%t#263K@ @8W%t#7W@	Short name: @6W%t#260K@ Order number: @6W%t#265K@	True
 SDIAG_AL-CAT_CPU_MR_M SG1_0012	PLC alarm	10	CPU maintenance required: @1W%t#7W@ @6W%t#257K@ / @5W%t#7W@ @6W%t#258K@ @6W%t#262K@ @6W%t#263K@ @8W%t#7W@	Short name: @6W%t#260K@ Order number: @6W%t#265K@	True
 SDIAG_AL-CAT_CPU_TMPER R_MSG_0013	PLC alarm	11	Temporary CPU error: @1W%t#7W@ @5W%t#7W@ @6W%t#257K@ / @6W%t#258K@ @6W%t#262K@ @6W%t#263K@ @8W%t#7W@	Short name: @6W%t#260K@ Order number: @6W%t#265K@	True
 SDIAG_AL-CAT_CH_ERR_MS G_0015	PLC alarm	12	Error: @1W%t#7W@ on @8W%t#280K@ @6W%t#257K@ / @6W%t#258K@.@6W%t#259K@ @6W%t#262K@ @6W%t#263K@	Short name: @6W%t#260K@ Order number: @6W%t#265K@	True
 SDIAG_AL-CAT_ECH_ERR_M SG_0016	PLC alarm	13	Error: @1W%t#7W@ - @5W%t#7W@ on @8W%t#280K@ @6W%t#257K@ / @6W%t#258K@.@6W%t#259K@ @6W%t#262K@ @6W%t#263K@	Short name: @6W%t#260K@ Order number: @6W%t#265K@	True
 SDIAG_AL-CAT_CH_MD_MS G_0018	PLC alarm	14	Maintenance demanded:@1W%t#7W@ on @8W%t#280K@ @6W%t#257K@ / @6W%t#258K@.@6W%t#259K@ @6W%t#262K@ @6W%t#263K@	Short name: @6W%t#260K@ Order number: @6W%t#265K@	True
 SDIAG_AL-CAT_ECH_MD_M SG_0019	PLC alarm	15	Maintenance demanded:@1W%t#7W@ - @5W%t#7W@ on @8W%t#280K@ @6W%t#257K@ / @6W%t#258K@.@6W%t#259K@ @6W%t#262K@ @6W%t#263K@	Short name: @6W%t#260K@ Order number: @6W%t#265K@	True
 SDIAG_AL-CAT_CH_MR_MS G_001B	PLC alarm	16	Maintenance required:@1W%t#7W@ on @8W%t#280K@ @6W%t#257K@ / @6W%t#258K@.@6W%t#259K@ @6W%t#262K@ @6W%t#263K@	Short name: @6W%t#260K@ Order number: @6W%t#265K@	True
 SDIAG_AL-CAT_ECH_MR_M SG_001C	PLC alarm	17	Maintenance required:@1W%t#7W@ - @5W%t#7W@ on @8W%t#280K@ @6W%t#257K@ / @6W%t#258K@.@6W%t#259K@ @6W%t#262K@ @6W%t#263K@	Short name: @6W%t#260K@ Order number: @6W%t#265K@	True
 SDIAG_AL-CAT_SUB_ERR_M SG_001E	PLC alarm	18	Error: @1W%t#7W@ @6W%t#257K@ / @6W%t#258K@.@6W%t#259K@ @6W%t#262K@ @6W%t#263K@	Short name: @6W%t#260K@ Order number: @6W%t#265K@	True
 SDIAG_AL-CAT_ESUB_ERR_M SG_001F	PLC alarm	19	Error: @1W%t#7W@ - @5W%t#7W@ @6W%t#257K@ / @6W%t#258K@.@6W%t#259K@ @6W%t#262K@ @6W%t#263K@	Short name: @6W%t#260K@ Order number: @6W%t#265K@	True
 SDIAG_AL-CAT_SUB_MD_M SG_0021	PLC alarm	20	Maintenance demanded: @1W%t#7W@ @6W%t#257K@ / @6W%t#258K@.@6W%t#259K@ @6W%t#262K@ @6W%t#263K@	Short name: @6W%t#260K@ Order number: @6W%t#265K@	True
 SDIAG_AL-CAT_ESUB_MD_M SG_0022	PLC alarm	21	Maintenance demanded: @1W%t#7W@ - @5W%t#7W@ @6W%t#257K@ / @6W%t#258K@.@6W%t#259K@ @6W%t#262K@ @6W%t#263K@	Short name: @6W%t#260K@ Order number: @6W%t#265K@	True
 SDIAG_AL-CAT_SUB_MR_M SG_0024	PLC alarm	22	Maintenance required: @1W%t#7W@ @6W%t#257K@ / @6W%t#258K@.@6W%t#259K@ @6W%t#262K@ @6W%t#263K@	Short name: @6W%t#260K@ Order number: @6W%t#265K@	True
 SDIAG_AL-CAT_ESUB_MR_M SG_0025	PLC alarm	23	Maintenance required: @1W%t#7W@ - @5W%t#7W@ @6W%t#257K@ / @6W%t#258K@.@6W%t#259K@ @6W%t#262K@ @6W%t#263K@	Short name: @6W%t#260K@ Order number: @6W%t#265K@	True
 SDIAG_AL-CAT_CONFIG_IN-FO_0028	PLC alarm	24	Info: @1W%t#7W@ - @5W%t#7W@ @6W%t#257K@ @6W%t#262K@ @6W%t#263K@ @8W%t#7W@	Short name: @6W%t#260K@ Order number: @6W%t#265K@	True
 SDIAG_AL-CAT_CONFIG_RE-PORT_0029	PLC alarm	25	Info: @1W%t#7W@ - @5W%t#7W@ @6W%t#257K@ / @6W%t#258K@ @6W%t#262K@ @6W%t#263K@	Short name: @6W%t#260K@ Order number: @6W%t#265K@	True
 SDIAG_AL-CAT_SE-CU_EV_MSG_005E	PLC alarm	26	Security event: @1W%t#7W@ @5W%t#7W@ @6W%t#258K@ @6W%t#262K@ @6W%t#263K@ @8W%t#7W@	Short name: @6W%t#260K@ Order number: @6W%t#265K@	True
 SDIAG_AL-CAT_SE-CU_EV_IN-FO_005F	PLC alarm	27	Security information: @1W%t#7W@ @5W%t#7W@ @6W%t#258K@ @6W%t#262K@ @6W%t#263K@ @8W%t#7W@	Short name: @6W%t#260K@ Order number: @6W%t#265K@	True

# Instrumentation Tools

Totally Integrated Automation Portal						
Name	Type	ID	Alarm text	Info text	Information only	
 SDIAG_AL-CAT_USER_MSG_0080	PLC alarm	28	User message: @1W%t#2W@	Short name: @6W%t#260K@ Order number: @6W%t#265K@	True	
 SDIAG_AL-CAT_PLC_MSG_0OFF	PLC alarm	29	PLC notification: @1W%t#7W@ @5W%t#7W@ @6W%t#256K@ @6W%t#262K@ @6W%t#263K@	Short name: @6W%t#260K@ Order number: @6W%t#265K@	True	
 SDIAG_AL-CAT_SUBMO-DUL_MSG_0102	PLC alarm	30	Error: @1W%t#7W@ @5W%t#7W@ @6W%t#257K@ / @6W%t#258K@.@6W%t#259K@ @6W%t#262K@ @6W%t#263K@	Short name: @6W%t#260K@ Order number: @6W%t#265K@	False	
 SDIAG_AL-CAT_MOD-UL_MSG_0103	PLC alarm	31	Error: @1W%t#7W@ @5W%t#7W@ @6W%t#257K@ / @6W%t#258K@ @6W%t#262K@ @6W%t#263K@	Short name: @6W%t#260K@ Order number: @6W%t#265K@	False	
 SDIAG_AL-CAT_RACK_MSG_0104	PLC alarm	32	Error: @1W%t#7W@ @5W%t#7W@ @6W%t#257K@ @6W%t#262K@ @6W%t#263K@	Short name: @6W%t#260K@ Order number: @6W%t#265K@	False	
 SDIAG_AL-CAT_DE-VICE_MSG_0105	PLC alarm	33	Error: @1W%t#7W@ @5W%t#7W@ @6W%t#257K@ @6W%t#262K@ @6W%t#263K@ @8W%t#7W@	Short name: @6W%t#260K@ Order number: @6W%t#265K@	False	
 SDIAG_AL-CAT_IOSYS-TEM_MSG_0106	PLC alarm	34	Error: @1W%t#7W@ @5W%t#7W@ @6W%t#276K@ @6W%t#262K@ @6W%t#263K@ @8W%t#7W@	Short name: @6W%t#260K@ Order number: @6W%t#265K@	False	
 SDIAG_AL-CAT_CPU_OST_MSG_010D	PLC alarm	35	CPU status message: @1W%t#7W@ @5W%t#7W@ @6W%t#257K@ / @6W%t#258K@ @6W%t#262K@ @6W%t#263K@ @8W%t#7W@	Short name: @6W%t#260K@ Order number: @6W%t#265K@	False	
 SDIAG_AL-CAT_CPU_ERR_M SG_0110	PLC alarm	36	CPU error: @1W%t#7W@ @5W%t#7W@ @6W%t#257K@ / @6W%t#258K@ @6W%t#262K@ @6W%t#263K@ @8W%t#7W@	Short name: @6W%t#260K@ Order number: @6W%t#265K@	False	
 SDIAG_AL-CAT_CPU_MD_M SG_0111	PLC alarm	37	CPU maintenance demanded: @1W%t#7W@ @6W%t#257K@ / @5W%t#7W@ @6W%t#258K@ @6W%t#262K@ @6W%t#263K@ @8W%t#7W@	Short name: @6W%t#260K@ Order number: @6W%t#265K@	False	
 SDIAG_AL-CAT_CPU_MR_M SG1_0112	PLC alarm	38	CPU maintenance required: @1W%t#7W@ @6W%t#257K@ / @5W%t#7W@ @6W%t#258K@ @6W%t#262K@ @6W%t#263K@ @8W%t#7W@	Short name: @6W%t#260K@ Order number: @6W%t#265K@	False	
 SDIAG_AL-CAT_CH_ERR_M SG_0115	PLC alarm	39	Error: @1W%t#7W@ on @8W%t#280K@ @6W%t#257K@ / @6W%t#258K@.@6W%t#259K@ @6W%t#262K@ @6W%t#263K@	Short name: @6W%t#260K@ Order number: @6W%t#265K@	False	
 SDIAG_AL-CAT_ECH_ERR_M SG_0116	PLC alarm	40	Error: @1W%t#7W@ - @5W%t#7W@ on @8W%t#280K@ @6W%t#257K@ / @6W%t#258K@.@6W%t#259K@ @6W%t#262K@ @6W%t#263K@	Short name: @6W%t#260K@ Order number: @6W%t#265K@	False	
 SDIAG_AL-CAT_CH_MD_M SG_0118	PLC alarm	41	Maintenance demanded: @1W%t#7W@ on @8W%t#280K@ @6W%t#257K@ / @6W%t#258K@.@6W%t#259K@ @6W%t#262K@ @6W%t#263K@	Short name: @6W%t#260K@ Order number: @6W%t#265K@	False	
 SDIAG_AL-CAT_ECH_MD_M SG_0119	PLC alarm	42	Maintenance demanded: @1W%t#7W@ - @5W%t#7W@ on @8W%t#280K@ @6W%t#257K@ / @6W%t#258K@.@6W%t#259K@ @6W%t#262K@ @6W%t#263K@	Short name: @6W%t#260K@ Order number: @6W%t#265K@	False	
 SDIAG_AL-CAT_CH_MR_M SG_011B	PLC alarm	43	Maintenance required: @1W%t#7W@ on @8W%t#280K@ @6W%t#257K@ / @6W%t#258K@.@6W%t#259K@ @6W%t#262K@ @6W%t#263K@	Short name: @6W%t#260K@ Order number: @6W%t#265K@	False	
 SDIAG_AL-CAT_ECH_MR_M SG_011C	PLC alarm	44	Maintenance required: @1W%t#7W@ - @5W%t#7W@ on @8W%t#280K@ @6W%t#257K@ / @6W%t#258K@.@6W%t#259K@ @6W%t#262K@ @6W%t#263K@	Short name: @6W%t#260K@ Order number: @6W%t#265K@	False	
 SDIAG_AL-CAT_SUB_ERR_M SG_011E	PLC alarm	45	Error: @1W%t#7W@ @6W%t#257K@ / @6W%t#258K@.@6W%t#259K@ @6W%t#262K@ @6W%t#263K@	Short name: @6W%t#260K@ Order number: @6W%t#265K@	False	
 SDIAG_AL-CAT_ESUB_ERR_M SG_011F	PLC alarm	46	Error: @1W%t#7W@ - @5W%t#7W@ @6W%t#257K@ / @6W%t#258K@.@6W%t#259K@ @6W%t#262K@ @6W%t#263K@	Short name: @6W%t#260K@ Order number: @6W%t#265K@	False	
 SDIAG_AL-CAT_SUB_MD_M SG_0121	PLC alarm	47	Maintenance demanded: @1W%t#7W@ @6W%t#257K@ / @6W%t#258K@.@6W%t#259K@ @6W%t#262K@ @6W%t#263K@	Short name: @6W%t#260K@ Order number: @6W%t#265K@	False	
 SDIAG_AL-CAT_ESUB_MD_M SG_0122	PLC alarm	48	Maintenance demanded: @1W%t#7W@ - @5W%t#7W@ @6W%t#257K@ / @6W%t#258K@.@6W%t#259K@ @6W%t#262K@ @6W%t#263K@	Short name: @6W%t#260K@ Order number: @6W%t#265K@	False	
 SDIAG_AL-CAT_SUB_MR_M SG_0124	PLC alarm	49	Maintenance required: @1W%t#7W@ @6W%t#257K@ / @6W%t#258K@.@6W%t#259K@ @6W%t#262K@ @6W%t#263K@	Short name: @6W%t#260K@ Order number: @6W%t#265K@	False	
 SDIAG_AL-CAT_ESUB_MR_M SG_0125	PLC alarm	50	Maintenance required: @1W%t#7W@ - @5W%t#7W@ @6W%t#257K@ / @6W%t#258K@.@6W%t#259K@ @6W%t#262K@ @6W%t#263K@	Short name: @6W%t#260K@ Order number: @6W%t#265K@	False	
 SDIAG_AL-CAT_CONFIG_IN-FO_0128	PLC alarm	51	Info: @1W%t#7W@ - @5W%t#7W@ @6W%t#257K@ @6W%t#262K@ @6W%t#263K@ @8W%t#7W@	Short name: @6W%t#260K@ Order number: @6W%t#265K@	False	
 SDIAG_AL-CAT_PLC_MSG_01FF	PLC alarm	52	PLC notification: @1W%t#7W@ @5W%t#7W@ @6W%t#256K@ @6W%t#262K@ @6W%t#263K@	Short name: @6W%t#260K@ Order number: @6W%t#265K@	False	

## Open User Communication TCON-TCP blocks / PLC\_2 [CPU 1516-3 PN/DP]

### PLC alarm text lists

This folder is empty.

## Open User Communication TCON-TCP blocks / PLC\_2 [CPU 1516-3 PN/DP] / Local modules

### PLC\_2 [CPU 1516-3 PN/DP]

#### PLC\_2

##### General\Project information

<b>Name</b>	PLC_2	<b>Author</b>	Mmuhamed	<b>Comment</b>	
<b>Rack</b>	0	<b>Slot</b>	1		

##### General\Catalog information

<b>Short designation</b>	CPU 1516-3 PN/DP	<b>Description</b>	CPU with display; work memory 1 MB code and 5 MB data; 10 ns bit operation time; 4-stage protection concept, technology functions: motion control, closed-loop control, counting and measuring; tracing; Runtime options; isochronous mode (central); for all PROFINET interfaces: transport protocol TCP/IP, secure Open User Communication, S7 communication, S7 routing, IP forwarding, Web server, DNS client, OPC UA: Server DA, Client DA, methods, companion specifications; 1st interface: PROFINET IO controller, supports RT/IRT, performance upgrade PROFINET V2.3, 2 ports, I-Device, MRP, MRPD, isochronous mode; 2nd interface: PROFINET IO controller, supports RT, I-Device; 3rd interface: PROFIBUS DP Master, S7 communication, isochronous mode, S7 routing; firmware V2.8	<b>Article number</b>	6ES7 516-3AN02-0AB0
<b>Firmware version</b>	V2.8				

##### General\Identification & Maintenance

<b>Plant designation</b>	<b>Location identifier</b>	<b>Installation date</b>	2023-12-19 08:24:18.917
<b>Additional information</b>			

##### General\Checksums

<b>Text lists</b>	FA 70 E8 75 1D 5A 8E 29	<b>Software</b>	51 01 8F A2 0D 18 25 FD
-------------------	-------------------------	-----------------	-------------------------

##### Connection resources\

	Station resources - Reserved - Maximum	Station resources - Reserved - Configured	Station resources - Dynamic - Configured	Module resources - PLC_2 [CPU 1516-3 PN/DP] - Configured
Maximum number of resources:		10	118	128
	Maximum	Configured	Configured	Configured
PG communication:	4	-	-	-
HMI communication:	4	0	0	0
S7 communication:	0	-	0	0
Open user communication:	0	-	0	0
Web communication:	2	-	-	-
OPC UA client/server communication:	0	-	-	-
Other communication:	-	-	0	0
Total resources used:		0	0	0
Available resources:		10	118	128

##### Overview of addresses\Overview of addresses\Overview of addresses

<b>Inputs</b>	True	<b>Outputs</b>	True	<b>Address gaps</b>	False
<b>Slot</b>	True				

## Open User Communication TCON-TCP blocks

### Ungrouped devices

This folder is empty.

## Open User Communication TCON-TCP blocks

### Security settings

This folder is empty.



Open User Communication TCON-TCP blocks / Cross-device functions / Project traces

## Measurements

This folder is empty.

## Open User Communication TCON-TCP blocks / Common data

### Alarm classes

Alarm classes			
Name	Display name	Acknowledgment	Priority
Acknowledgement	A	True	0
No Acknowledgement	NA	False	0

## Open User Communication TCON-TCP blocks / Common data

### Logs

This folder is empty.

## Open User Communication TCON-TCP blocks / Languages & resources

### Project languages

#### Languages

##### Reference language

English (United States)

##### Editing language

English (United States)

##### Other project languages

Empty

## Open User Communication TCON-TCP blocks / Languages & resources / Project texts

### Project texts

Project texts		
English (United States)	Category	Reference
"Main Program Sweep (Cycle)"	Block comment	Open User Communication TCON-TCP blocks\PLC_1 [CPU 1516-3 PN/DP]\Program blocks\Main [OB1]\Block title
"Main Program Sweep (Cycle)"	Block comment	Open User Communication TCON-TCP blocks\PLC_2 [CPU 1516-3 PN/DP]\Program blocks\Main [OB1]\Block title
A	Alarm class text	Open User Communication TCON-TCP blocks\Acknowledgement\AlarmClassData_IDisplay-Naming_DisplayName
A	Alarm class text	Open User Communication TCON-TCP blocks\Acknowledgement\ShortName
NA	Alarm class text	Open User Communication TCON-TCP blocks\No Acknowledgement\AlarmClassData_IDisplay-Naming_DisplayName
NA	Alarm class text	Open User Communication TCON-TCP blocks\No Acknowledgement\ShortName