

Instrumentation Tools

Totally Integrated Automation Portal		
--------------------------------------	--	--

HMI visualization--- Faceplates

Project							
Name:	HMI visualization--- Face-plates	Creation time:	8/7/2023 8:57:33 AM	Last change	8/22/2023 9:33:36 AM	Author:	Mmuhamed
Last modified by:	Mmuhamed	Version:					
Comment:							

Operating system	
Name	Description
Operating system	Microsoft Windows 10 Pro
Version of the operating system	6.3.9600.0
Operating system service pack	
Version of the Internet Explorer	11.789.19041.0
Computer name	MMUHAMED-D1
User name	GULSANEGYPT\Mmuhamed
Installation path of the TIA Portal	C:\Program Files\Siemens\Automation\Portal V16

Components		
Name	Version	Release
TIA Portal Project Server V16 - TIA Portal Project Server Single SetupPackage V16.0 (MUSERVERV16)	V16.0	V16.00.00.00_31.02.00.01
Siemens Totally Integrated Automation Portal V16 - SIMATIC S7-PLCSIM V16.0 (S7_PLCSIM_V16)	V16.0	V16.00.00.00_31.00.13.01
TIA Administrator - AWB Licensing Module V1.0 + SP2 (TIAADMIN)	V1.0 + SP2	V01.00.02.00_01.10.00.01
TIA Administrator - AWB Software Management V1.0 + SP2 (TIAADMIN)	V1.0 + SP2	V01.00.02.00_01.10.00.01
TIA Administrator - TIA UMC Agent Configurator Module V1.0 + SP2 (TIAADMIN)	V1.0 + SP2	V01.00.02.00_01.10.00.01
TIA Administrator - TIA Administrator V1.0 SP2 (TIAADMIN)	V1.0 + SP2	V01.00.02.00_01.10.00.01
Siemens Totally Integrated Automation Portal V16 - HM All Editions Single SetupPackage V16.0 (TIAP16)	V16.0	V16.00.00.00_31.02.00.01
Siemens Totally Integrated Automation Portal V16 - HM NoBasic Single SetupPackage V16.0 (TIAP16)	V16.0	V16.00.00.00_31.02.00.01
Siemens Totally Integrated Automation Portal V16 - Hardware Support Base Package 0 V16.0 (TIAP16)	V16.0	V16.00.00.00_27.01.00.01
Siemens Totally Integrated Automation Portal V16 - Multiuser Client Single SetupPackage V16.0 (TIAP16)	V16.0	V16.00.00.00_31.02.00.01
Siemens Totally Integrated Automation Portal V16 - Version Control Interface SetupPackage V16.0 (TIAP16)	V16.0	V16.00.00.00_31.02.00.01
Siemens Totally Integrated Automation Portal V16 - STEP 7 Safety Single SetupPackage V16.0 (TIAP16)	V16.0	V16.00.00.00_31.02.00.01
Siemens Totally Integrated Automation Portal V16 - SINAMICS Startdrive G110M, G120, G120C, G120D, G120P V16.0 (TIAP16)	V16.0	V16.00.00.00_20.00.00.04
Siemens Totally Integrated Automation Portal V16 - Startdrive Hardware Support Base Package 1 V16.0 (TIAP16)	V16.0	V16.00.00.00_20.00.00.04
Siemens Totally Integrated Automation Portal V16 - SINAMICS-STARTDRIVE-COMMON V16.0 (TIAP16)	V16.0	V16.00.00.00_20.00.00.04
Siemens Totally Integrated Automation Portal V16 - SINAMICS-STARTDRIVE-COMMON-OPENNESS V16.0 (TIAP16)	V16.0	V16.00.00.00_20.00.00.04
Siemens Totally Integrated Automation Portal V16 - SINAMICS-STARTDRIVE-COMMON-SAT V16.0 (TIAP16)	V16.0	V16.00.00.00_20.00.00.04
Siemens Totally Integrated Automation Portal V16 - SINAMICS Startdrive G130, G150, S120, S150, SINAMICS MV V16.0 (TIAP16)	V16.0	V16.00.00.00_20.00.00.04
Siemens Totally Integrated Automation Portal V16 - STEP 7 Single SetupPackage V16.0 (TIAP16)	V16.0	V16.00.00.00_31.02.00.01
Siemens Totally Integrated Automation Portal V16 - Hardware Support Base Package 02 V16.0 (TIAP16)	V16.0	V16.00.00.00_27.01.00.01
Siemens Totally Integrated Automation Portal V16 - Hardware Support Base Package 03 V16.0 (TIAP16)	V16.0	V16.00.00.00_27.01.00.01
Siemens Totally Integrated Automation Portal V16 - Hardware Support Base Package 04 V16.0 (TIAP16)	V16.0	V16.00.00.00_27.01.00.01
Siemens Totally Integrated Automation Portal V16 - Support Base Package TO-01 V16.0 (TIAP16)	V16.0	V16.00.00.00_27.01.00.01
Siemens Totally Integrated Automation Portal V16 - Support Base Package TO-02 V16.0 (TIAP16)	V16.0	V16.00.00.00_27.01.00.01
Siemens Totally Integrated Automation Portal V16 - Hardware Support Base Package WCF-01 V16.0 (TIAP16)	V16.0	V16.00.00.00_27.01.00.01
Siemens Totally Integrated Automation Portal V16 - TIACOMPCHCK Single SetupPackage V16.0 (TIAP16)	V16.0	V16.00.00.00_31.02.00.01
Siemens Totally Integrated Automation Portal V16 - Simatic Single SetupPackage V16.0 (TIAP16)	V16.0	V16.00.00.00_31.02.00.01
Siemens Totally Integrated Automation Portal V16 - WinCC Single SetupPackage V16.0 (TIAP16)	V16.0	V16.00.00.00_31.02.00.01
Siemens Totally Integrated Automation Portal V16 - Openness SetupPackage V16.0 (TIAP16)	V16.0	V16.00.00.00_31.02.00.01
Siemens Totally Integrated Automation Portal V16 - WinCC Transfer Mandatory Single SetupPackage V16.0 (TIAP16)	V16.0	V16.00.00.00_31.02.00.01
User Management Component - UserManagementComponentx64 V2.7 (UMC64)	V2.7	V02.07.00.00_04.06.00.07
WinCC Runtime Advanced V16.0 - HMIRTM Tagging Package 01 Single SetupPackage V16.0 (HMIRTM_V11)	V16.0	V16.00.00.00_31.02.00.01
WinCC Runtime Professional V16 - SIMATIC WinCC Runtime V16.0 (SCADA-RT_V11)	V16.0	V07.05.56.00_01.43.00.01
WinCC Runtime Professional V16 - OPCUA_Client V1.1 + SP1 (SCADA-RT_V11)	V1.1 + SP1	V01.01.01.00_01.11.00.01
WinCC Runtime Professional V16 - SCADA Simulation Single SetupPackage V16.0 (SCADA-RT_V11)	V16.0	V16.00.00.00_31.02.00.01

Instrumentation Tools

Totally Integrated Automation Portal		
--------------------------------------	--	--

Name	Version	Release
Siemens Totally Integrated Automation Portal V16 - Simatic Single Setup-Package 32 Bit V16.0 (TIAP16)	V16.0	V16.00.00.00_31.02.00.01
Siemens Totally Integrated Automation Portal V16 - WinCC Single Setup-Package 32 Bit V16.0 (TIAP16)	V16.0	V16.00.00.00_31.02.00.01
SIMATIC HMI License Manager Panel Plugin (x64)	16.0.0.0	V16.00.00.00_31.02.00.01
SIMATIC WinCC Runtime Advanced Driver (x64)	16.0.0.0	V16.00.00.00_31.02.00.01
ETWEventCollector	16.0.0.0	V16.00.00.00_31.02.00.01
SIMATIC NCM FWL 64	5.6.0.3	K5.6.0.3_1.1.0.2
NCM GPRS 64	01.02.00.00	V1.2.0.0_2.1.0.1
SIMATIC PLCSIM 64	16.00.00	16.00.00.00_01.00.02.01
SIMATIC Device Drivers	9.2	09.02.04.00_01.04.00.05
TelemetryConnector	1.0.2.57	V01.00.02.57_01.00.00.01
Automation Software Updater	02.05.0300	V02.05.03.00_01.01.00.29
SIMATIC HMIProvider	7.0	K07.00.03.01_01.01.00.01
SIEMENS OPC	3.9	03.09.10.00_01.04.00.08
SIMATIC HMI ProSave	16.0.0.0	V16.00.00.00_31.02.00.01
SIMATIC HMI Symbol Library	16.0.0.0	V16.00.00.00_31.02.00.01
SIMATIC HMI Touch Input	16.0.0.0	V16.00.00.00_31.02.00.01
SIMATIC Runtime Interfaces	2.1	K02.01.00.03_01.01.00.01
SIMATIC Device Drivers WoW	29.2	29.02.04.00_01.04.00.05
SIMATIC Event Database	5.6	05.06.02.00_01.01.00.01
SeCon	2.6	V02.06.01.00_01.08.00.01
SIMATIC Station Observer	K7.3.1.0	V07.03.01.00_01.01.00.14
SIMATIC SCS	K7.5.2.2	V07.05.02.02_01.03.00.04
SIMATIC WinCC Common Archiving	V7.5.0.0	V07.05.56.00_01.43.00.01
WinCC Runtime Advanced Simulator	16.0.0.0	V16.00.00.00_31.02.00.01

Products		
Name	Version	Release
TIA Portal Project Server	V16.0	V16.00.00.00_31.02.00.01
SIMATIC S7-PLCSIM	V16.0	V16.00.00.00_31.00.13.01
TIA Administrator	V1.0	01.00.02.00_01.10.00.01
SINAMICS G110M, G120, G120C, G120D, G120P	V16.0	V16.00.00.00_20.00.00.04
SINAMICS G130, G150, S120, S150, SINAMICS MV, S210	V16.0	V16.00.00.00_20.00.00.04
SIMATIC STEP 7 Prof - STEP 7 Safety - WinCC Prof	V16.0	V16.00.00.00_31.02.00.01
User Management Component	V2.7	V02.07.00.00_00.00.00.00
SIMATIC WinCC Runtime Advanced Simulation	V16.0	V16.00.00.00_31.02.00.01
SIMATIC WinCC Runtime Professional Simulation	V16.0	V16.00.00.00_31.02.00.01
Automation License Manager	V6.0 + SP5 + Upd1	06.00.05.01_02.01.00.05
S7-PLCSIM	V5.4 + SP8	V05.04.08.01_01.24.00.01
SIMATIC ProSave	V16.0	V16.00.00.00_31.02.00.01
S7-PCT	V3.5 + SP1	K3.5.1.0_1.19.0.1

HMI visualization--- Faceplates

PLC_1 [CPU 1512C-1 PN]

PLC_1

General\Project information

Name	PLC_1	Author	Mmuhamed	Comment	
Rack	0	Slot	1		

General\Catalog information

Short designation	CPU 1512C-1 PN	Description	CPU with display; work memory 250 KB code and 1 MB data; 48 ns bit operation time; 4-stage protection concept, technology functions: motion control, closed-loop control, counting and measuring; tracing; Runtime options; for all PROFINET interfaces: transport protocol TCP/IP, secure Open User Communication, S7 communication, S7 routing, IP forwarding, Web server, DNS client, OPC UA: Server DA, Client DA, methods, companion specifications; PROFINET IO controller, supports RT/IRT, performance upgrade PROFINET V2.3, 2 ports, I-Device, MRP, MRPD, isochronous mode, Routing, runtime options; firmware V2.8 with DI32/DQ32, AI5/AQ2: Digital input module DI16 x DC24V, grouping 16; Digital output module DQ16 x DC24V/0.5A, grouping 16; Analog input module AI4 x U/I, AI 1xRTD, 16-bit, grouping 5; Analog output module AQ2 x U/I, 16-bit, grouping 2; 6 channels for counting and measuring with incremental encoders 24V (up to 100kHz); 4 channels for PTO, pulse width modulation, frequency output (up to 100kHz)	Article number	6ES7 512-1CK01-0AB0
Firmware version	V2.8				

General\Identification & Maintenance

Plant designation		Location identifier		Installation date	2023-08-07 08:58:52.401
Additional information					

General\Checksums

Text lists	FA 70 E8 75 1D 5A 8E 29	Software	C8 50 6F BC 2B E7 E9 2B
-------------------	-------------------------	-----------------	-------------------------

Connection resources\

	Station resources - Reserved - Maximum	Station resources - Reserved - Configured	Station resources - Dynamic - Configured	Module resources - PLC_1 [CPU 1512C-1 PN] - Configured
Maximum number of resources:	10	78	88	
	Maximum	Configured	Configured	Configured
PG communication:	4	-	-	-
HMI communication:	4	2	0	2
S7 communication:	0	-	0	0
Open user communication:	0	-	0	0
Web communication:	2	-	-	-
OPC UA client/server communication:	0	-	-	-
Other communication:	-	-	0	0
Total resources used:	2	0	2	
Available resources:	8	78	86	

Overview of addresses\Overview of addresses\Overview of addresses

Inputs	True	Outputs	True	Address gaps	False
Slot	True				

Instrumentation Tools

Totally Integrated Automation Portal											
Type	Addr. from	Addr. to	Module	PIP	OB	Device name	Device number	Size	Master / IO system	Rack	Slot
I	0	9	AI 5/AQ 2_1	Automatic update	-	PLC_1 [CPU 1512C-1 PN]	-	10 Bytes	-	0	1 8
O	0	3	AI 5/AQ 2_1	Automatic update	-	PLC_1 [CPU 1512C-1 PN]	-	4 Bytes	-	0	1 8
I	10	11	DI 16/DQ 16_1	Automatic update	-	PLC_1 [CPU 1512C-1 PN]	-	2 Bytes	-	0	1 9
O	4	5	DI 16/DQ 16_1	Automatic update	-	PLC_1 [CPU 1512C-1 PN]	-	2 Bytes	-	0	1 9
I	12	13	DI 16/DQ 16_2	Automatic update	-	PLC_1 [CPU 1512C-1 PN]	-	2 Bytes	-	0	1 10
O	6	7	DI 16/DQ 16_2	Automatic update	-	PLC_1 [CPU 1512C-1 PN]	-	2 Bytes	-	0	1 10
I	14	29	HSC_1	Automatic update	-	PLC_1 [CPU 1512C-1 PN]	-	16 Bytes	-	0	1 16
O	8	19	HSC_1	Automatic update	-	PLC_1 [CPU 1512C-1 PN]	-	12 Bytes	-	0	1 16
I	30	45	HSC_2	Automatic update	-	PLC_1 [CPU 1512C-1 PN]	-	16 Bytes	-	0	1 17
O	20	31	HSC_2	Automatic update	-	PLC_1 [CPU 1512C-1 PN]	-	12 Bytes	-	0	1 17
I	46	61	HSC_3	Automatic update	-	PLC_1 [CPU 1512C-1 PN]	-	16 Bytes	-	0	1 18
O	32	43	HSC_3	Automatic update	-	PLC_1 [CPU 1512C-1 PN]	-	12 Bytes	-	0	1 18
I	62	77	HSC_4	Automatic update	-	PLC_1 [CPU 1512C-1 PN]	-	16 Bytes	-	0	1 19
O	44	55	HSC_4	Automatic update	-	PLC_1 [CPU 1512C-1 PN]	-	12 Bytes	-	0	1 19
I	78	93	HSC_5	Automatic update	-	PLC_1 [CPU 1512C-1 PN]	-	16 Bytes	-	0	1 20
O	56	67	HSC_5	Automatic update	-	PLC_1 [CPU 1512C-1 PN]	-	12 Bytes	-	0	1 20
I	94	109	HSC_6	Automatic update	-	PLC_1 [CPU 1512C-1 PN]	-	16 Bytes	-	0	1 21
O	68	79	HSC_6	Automatic update	-	PLC_1 [CPU 1512C-1 PN]	-	12 Bytes	-	0	1 21
I	110	113	Pulse_1	Automatic update	-	PLC_1 [CPU 1512C-1 PN]	-	4 Bytes	-	0	1 32
O	80	91	Pulse_1	Automatic update	-	PLC_1 [CPU 1512C-1 PN]	-	12 Bytes	-	0	1 32
I	114	117	Pulse_2	Automatic update	-	PLC_1 [CPU 1512C-1 PN]	-	4 Bytes	-	0	1 33
O	92	103	Pulse_2	Automatic update	-	PLC_1 [CPU 1512C-1 PN]	-	12 Bytes	-	0	1 33
I	118	121	Pulse_3	Automatic update	-	PLC_1 [CPU 1512C-1 PN]	-	4 Bytes	-	0	1 34
O	104	115	Pulse_3	Automatic update	-	PLC_1 [CPU 1512C-1 PN]	-	12 Bytes	-	0	1 34
I	122	125	Pulse_4	Automatic update	-	PLC_1 [CPU 1512C-1 PN]	-	4 Bytes	-	0	1 35
O	116	127	Pulse_4	Automatic update	-	PLC_1 [CPU 1512C-1 PN]	-	12 Bytes	-	0	1 35

HMI visualization--- Faceplates / PLC_1 [CPU 1512C-1 PN]

Software units

This folder is empty.

HMI visualization--- Faceplates / PLC_1 [CPU 1512C-1 PN] / Program blocks

Main [OB1]

Main Properties

General

Name	Main	Number	1	Type	OB	Language	LAD
-------------	------	---------------	---	-------------	----	-----------------	-----

Numbering	Automatic
------------------	-----------

Information

Title	"Main Program Sweep (Cycle)"	Author		Comment		Family	
--------------	------------------------------	---------------	--	----------------	--	---------------	--

Version	0.1	User-defined ID	
----------------	-----	------------------------	--

Name	Data type	Default value
▼ Input		
Initial_Call	Bool	
Remanence	Bool	
Temp		
Constant		

Network 1: simulation of TANK1 analog input of the level sensor to the PLC

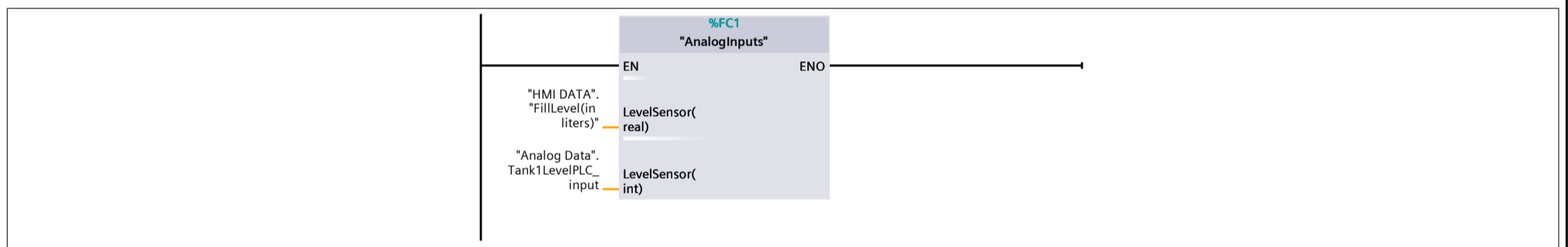

Network 2: simulation of TANK2 analog input of the level sensor to the PLC

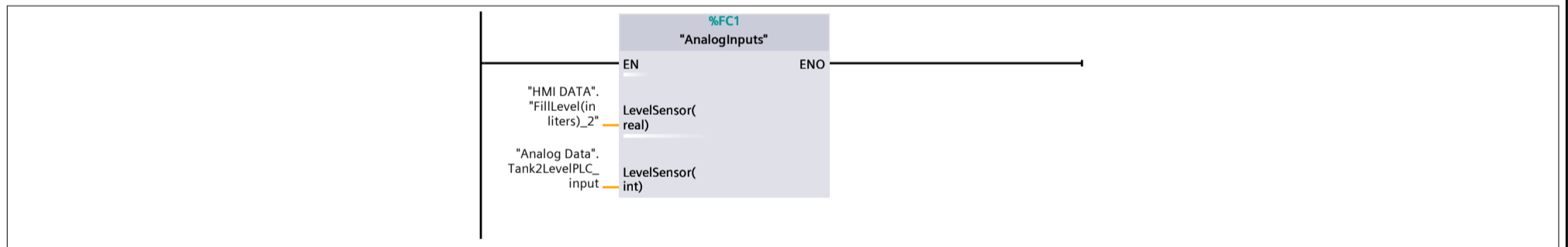

Network 3: Simulation of the behaviour of the pump of 0-10 liters/sec in corresponding to 0-10v PLC output

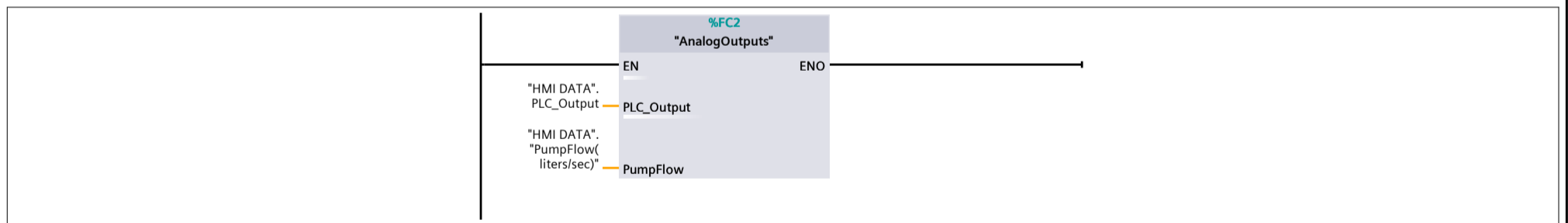

Network 4: SIMULATION OF THE TANK2 pump output corresponding to the ON/OFF behavior of the PID_PWM

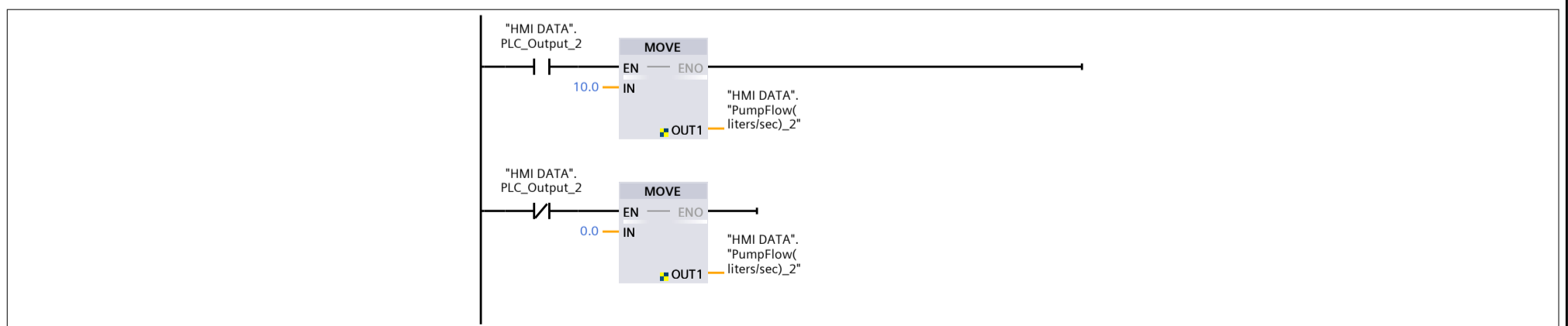

Network 5: empty tank and PID integral sum

Instrumentation Tools

Totally Integrated
Automation Portal

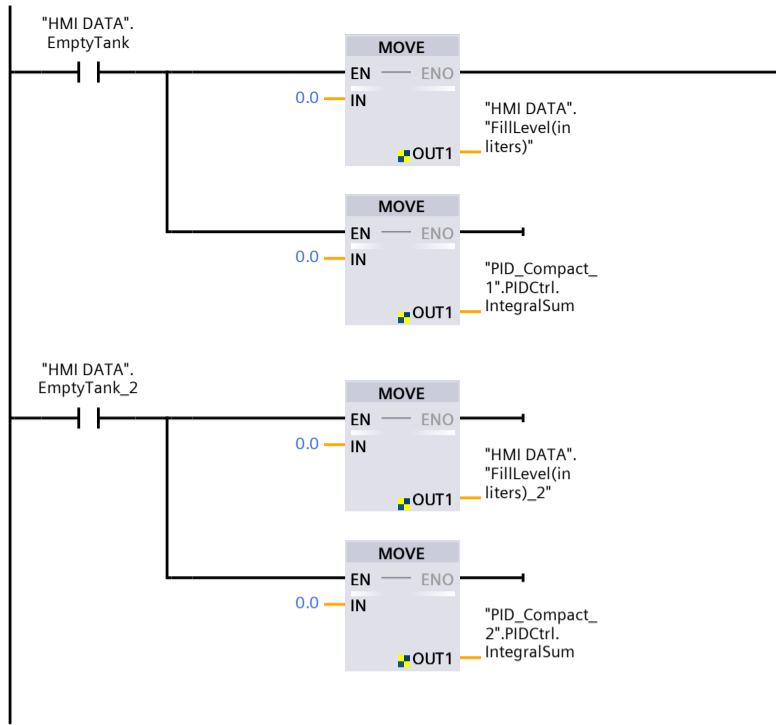

HMI visualization--- Faceplates / PLC_1 [CPU 1512C-1 PN] / Program blocks

Analog Data [DB1]

Analog Data Properties

General

Name	Analog Data	Number	1	Type	DB	Language	DB
-------------	-------------	---------------	---	-------------	----	-----------------	----

Numbering	Automatic
------------------	-----------

Information

Title		Author		Comment		Family	
--------------	--	---------------	--	----------------	--	---------------	--

Version	0.1	User-defined ID	
----------------	-----	------------------------	--

Name	Data type	Start value	Retain
▼ Static			
Tank1LevelPLC_input	Int	0	False
Tank2LevelPLC_input	Int	0	False

HMI visualization--- Faceplates / PLC_1 [CPU 1512C-1 PN] / Program blocks

AnalogInputs [FC1]

AnalogInputs Properties

General

Name	AnalogInputs	Number	1	Type	FC	Language	LAD
Numbering	Automatic						

Information

Title		Author		Comment	this block will simulate the existance of a real level sensor. we don't acutally have a real level sensor, so we will simulate this sensor as fo-low	Family	
Version	0.1	User-defined ID					

Name	Data type	Default value
▼ Input		
LevelSensor(real)	Real	
Output		
▼ InOut		
LevelSensor(int)	Int	
▼ Temp		
calculation1	Real	
calculation2	Real	
LevelSensor(V)	Real	
Constant		
▼ Return		
AnalogInputs	Void	

Network 1:

A level sensor will convert a 0-50liters level measurements into a 0-10 V signal. which then goes into the PLC Input module

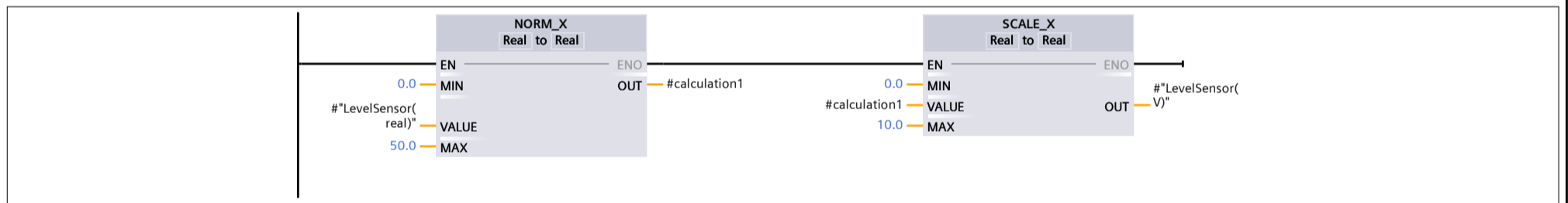

Network 2:

the 0-10V readings at the input module will be converted to the 0-50 liters measurements of the sensor

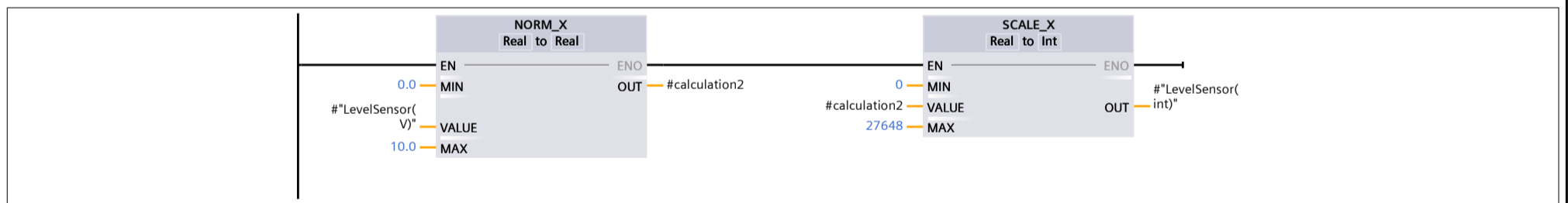

HMI visualization--- Faceplates / PLC_1 [CPU 1512C-1 PN] / Program blocks

AnalogOutputs [FC2]

AnalogOutputs Properties

General

Name	AnalogOutputs	Number	2	Type	FC	Language	LAD
Numbering	Automatic						

Information

Title		Author		Comment		Family	
Version	0.1	User-defined ID					

Name	Data type	Default value
▼ Input		
PLC_Output	Int	
Output		
▼ InOut		
PumpFlow	Real	
▼ Temp		
calculation1	Real	
calculation2	Real	
PumpOut	Real	
Constant		
▼ Return		
AnalogOutputs	Void	

Network 1:

PLC output module will take the output value 0-32767 and convert it to analog range of 0-10V

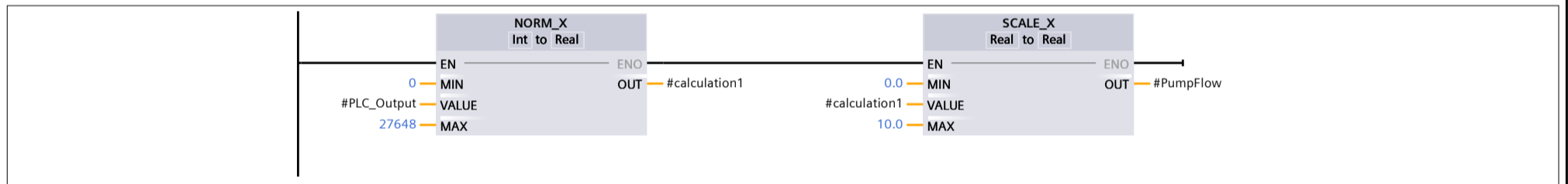

HMI visualization--- Faceplates / PLC_1 [CPU 1512C-1 PN] / Program blocks

Tank Simulator [FB2]

Tank Simulator Properties

General							
Name	Tank Simulator	Number	2	Type	FB	Language	LAD
Numbering	Automatic						
Information							
Title		Author		Comment		Family	
Version	0.1	User-defined ID					
Name	Data type	Default value	Retain				
▼ Input							
OutflowDisturbance %/ms	Real	0.0	Non-retain				
RandomDisturbance (1-4)	Int	0	Non-retain				
PumpFlow (liters/sec)	Real	0.0	Non-retain				
Output							
▼ InOut							
FillLevel	Real	0.0	Non-retain				
IdleTime(ms)	Int	0	Non-retain				
Setpoint(liters)	Real	0.0	Non-retain				
▼ Static							
Pump Output real (l/ms)	Real	0.0	Non-retain				
Pump Memory	Array[0..9999] of Real		Non-retain				
Pump Memory i	Int	0	Non-retain				
Pump Memory Result	Real	0.0	Non-retain				
▼ Temp							
Disturbance power	Real						
Random	Int						
SytemTime	DWord						
Constant							

Network 1: setpoint clamping



Network 2: Idle time clamping

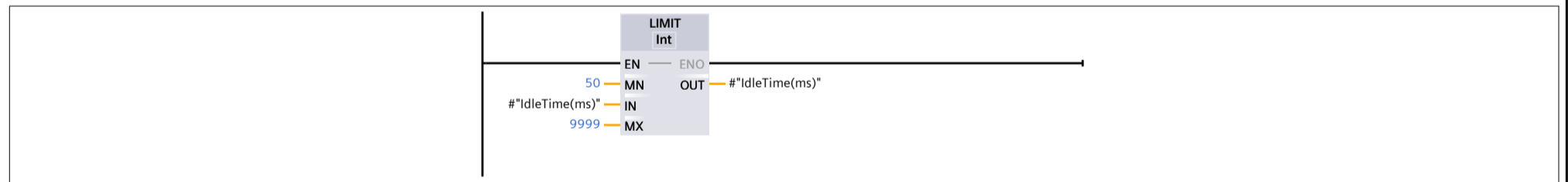

Network 3: pump output memory

This code is collecting and processing pump flow rates and tank status. It calculates the average pump flow rate over a 1ms(which is the calling interval of the cyclic interrupt) interval and resets the data if the tank is empty is activ.

```

0001 #Pump Memory Result := 0;
0002 FOR #Pump Memory i := 1 TO #IdleTime(ms) DO
0003     #Pump Memory[#Pump Memory i - 1] := #Pump Memory[#Pump Memory i];
0004     #Pump Memory Result += #Pump Memory[#Pump Memory i - 1];
0005 END_FOR;
0006
0007 #Pump Memory[#IdleTime(ms)] := #PumpFlow (liters/sec)";
0008 #Pump Memory Result += #Pump Memory[#IdleTime(ms)];
0009 #Pump Memory Result /= #IdleTime(ms)";
0010
0011
0012 IF "HMI DATA".EmptyTank THEN
0013     FOR #Pump Memory i := 0 TO #IdleTime(ms) DO
0014         #Pump Memory[#Pump Memory i] := 0;
0015     END_FOR;
0016 END_IF;
    
```

Network 4: Tank level progress

Instrumentation Tools

Totally Integrated Automation Portal

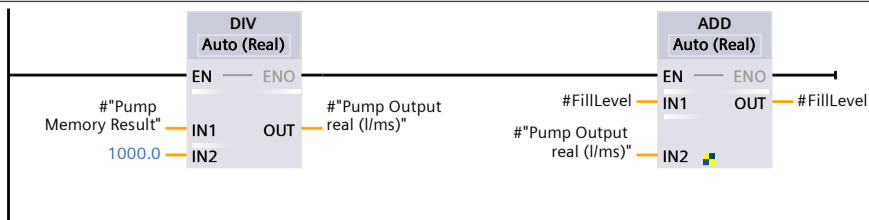

Network 5: Random value for disturbance - 1st step

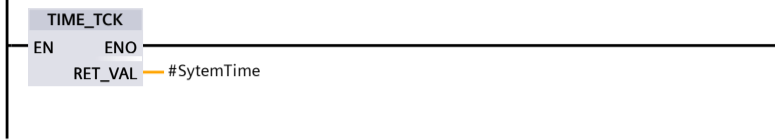

Network 6: random value of disturbance- 2nd step

```
0001 #Random := (DWORD_TO_DINT(#SytemTime) MOD 10);
```

Network 7: random disturbance strength

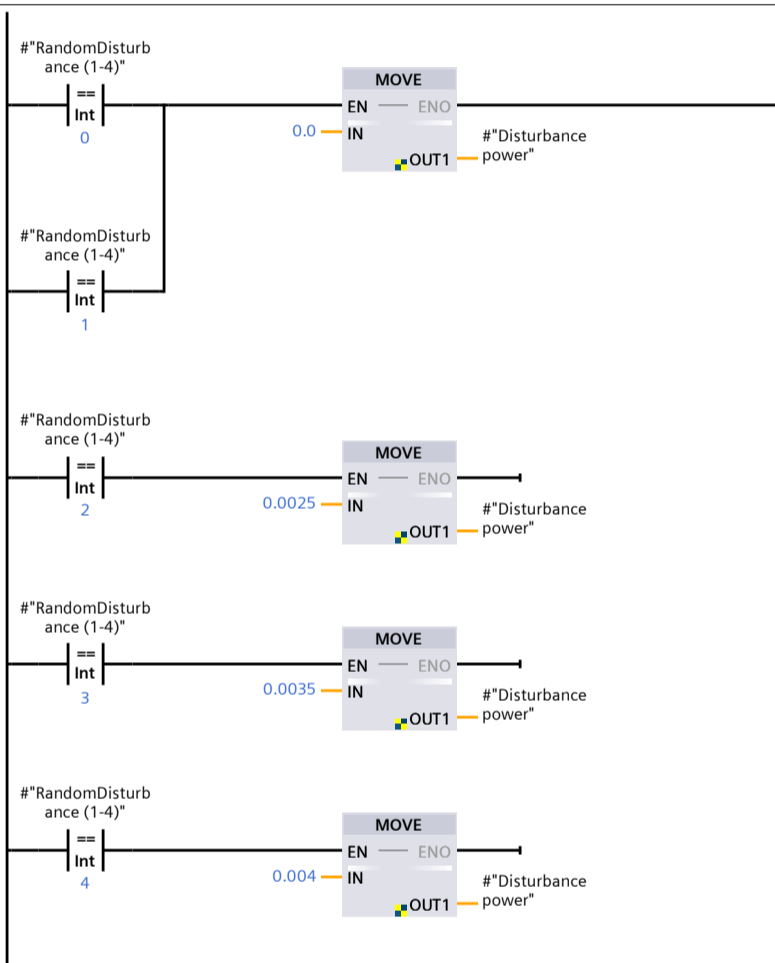

Network 8: Disturbance- random

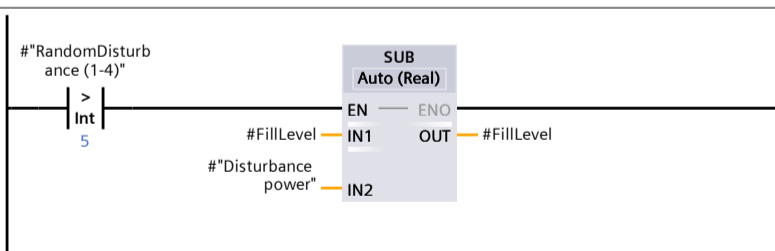

Network 9: Disturbance- outflow

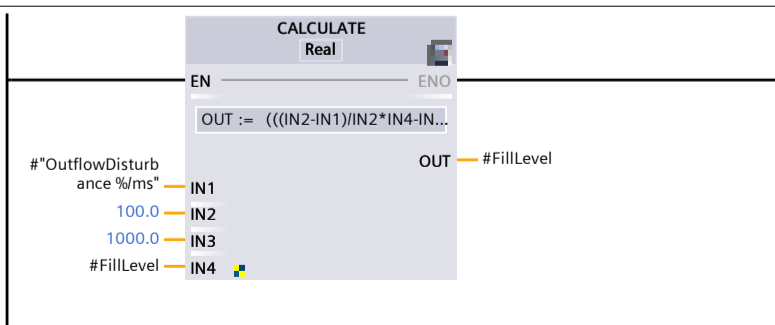

Network 10: fill level clamping

Instrumentation Tools

Totally Integrated
Automation Portal



HMI visualization--- Faceplates / PLC_1 [CPU 1512C-1 PN] / Program blocks

Cyclic_interrupt_1ms_TANK2Simulation [OB30]

Cyclic_interrupt_1ms_TANK2Simulation Properties

General

Name	Cyclic_interrupt_1ms_TANK2Simulation	Number	30	Type	OB	Language	LAD
-------------	--------------------------------------	---------------	----	-------------	----	-----------------	-----

Numbering

Numbering	Automatic
------------------	-----------

Information

Title		Author		Comment		Family	
Version	0.1	User-defined ID					

Name	Data type	Default value
▼ Input		
Initial_Call	Bool	
Event_Count	Int	
Temp		
Constant		

Network 1:

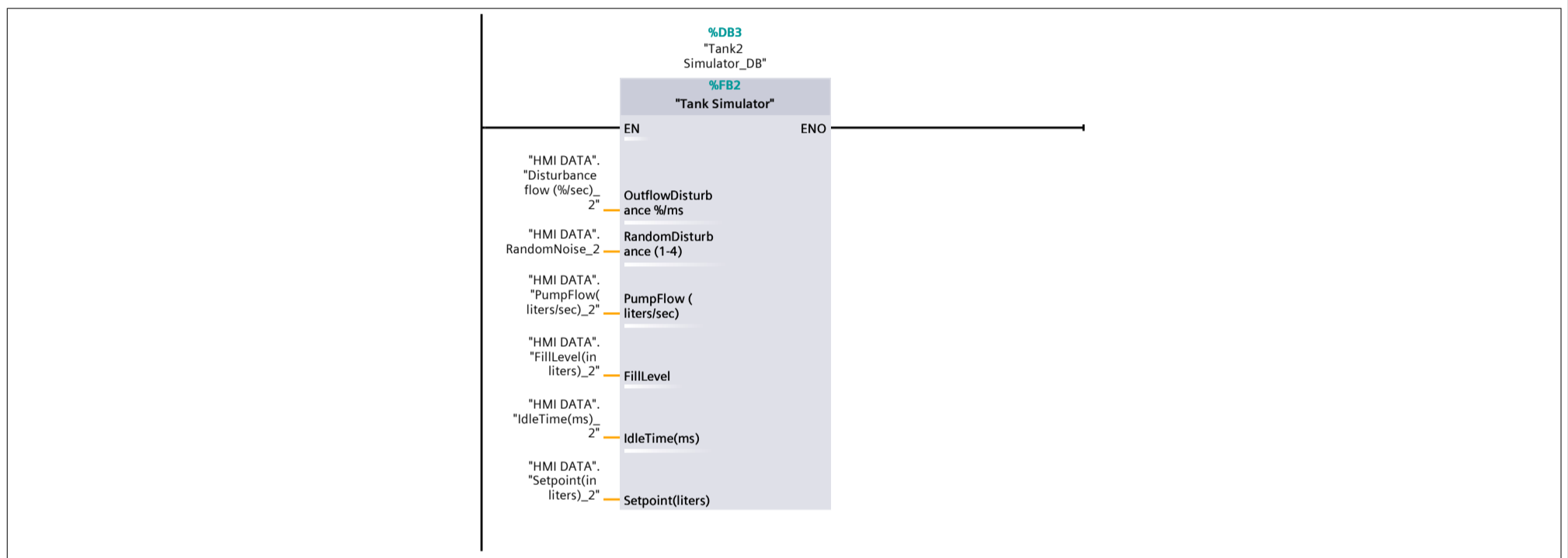

HMI visualization--- Faceplates / PLC_1 [CPU 1512C-1 PN] / Program blocks

HMI DATA [DB2]

HMI DATA Properties

General

Name	HMI DATA	Number	2	Type	DB	Language	DB
-------------	----------	---------------	---	-------------	----	-----------------	----

Numbering	Automatic
------------------	-----------

Information

Title		Author		Comment		Family	
--------------	--	---------------	--	----------------	--	---------------	--

Version	0.1	User-defined ID	
----------------	-----	------------------------	--

Name	Data type	Start value	Retain
▼ Static			
FillLevel(in liters)	Real	0.0	False
Setpoint(in liters)	Real	0.0	False
PumpFlow(liters/sec)	Real	0.0	False
PLC_Output	In t	0	False
SystemNoise	Real	0.0	False
Tolerance(in liters)	Real	0.0	False
IdleTime(ms)	In t	0	False
RandomNoise	In t	0	False
EmptyTank	Bool	false	False
Disturbance flow (%/sec)	Real	0.0	False
Disturbance flow (%/sec)_2	Real	0.0	False
FillLevel(in liters)_2	Real	0.0	False
Setpoint(in liters)_2	Real	0.0	False
PumpFlow(liters/sec)_2	Real	0.0	False
PLC_Output_2	Bool	false	False
SystemNoise_2	Real	0.0	False
Tolerance(in liters)_2	Real	0.0	False
IdleTime(ms)_2	In t	0	False
RandomNoise_2	In t	0	False
EmptyTank_2	Bool	false	False

HMI visualization--- Faceplates / PLC_1 [CPU 1512C-1 PN] / Program blocks

Tank Simulator_DB [DB5]

Tank Simulator_DB Properties

General

Name	Tank Simulator_DB	Number	5	Type	DB	Language	DB
-------------	-------------------	---------------	---	-------------	----	-----------------	----

Numbering	Automatic
------------------	-----------

Information

Title		Author		Comment		Family	
--------------	--	---------------	--	----------------	--	---------------	--

Version	0.1	User-defined ID	
----------------	-----	------------------------	--

Name	Data type	Start value	Retain
▼ Input			
OutflowDisturbance %/ms	Real	0.0	False
RandomDisturbance (1-4)	Int	0	False
PumpFlow (liters/sec)	Real	0.0	False
Output			
▼ InOut			
FillLevel	Real	0.0	False
IdleTime(ms)	Int	0	False
Setpoint(liters)	Real	0.0	False
▼ Static			
Pump Output real (l/ms)	Real	0.0	False
Pump Memory	Array[0..9999] of Real		False
Pump Memory i	Int	0	False
Pump Memory Result	Real	0.0	False

HMI visualization--- Faceplates / PLC_1 [CPU 1512C-1 PN] / Program blocks

Cyclic interrupt_TankLevel_PID_Output [OB31]

Cyclic interrupt_TankLevel_PID_Output Properties

General

Name	Cyclic interrupt_TankLevel_PID_Output	Number	31	Type	OB	Language	LAD
-------------	---------------------------------------	---------------	----	-------------	----	-----------------	-----

Numbering Automatic

Information

Title		Author		Comment		Family	
Version	0.1	User-defined ID					

Name	Data type	Default value
▼ Input		
Initial_Call	Bool	
Event_Count	Int	
Temp		
Constant		

Network 1:

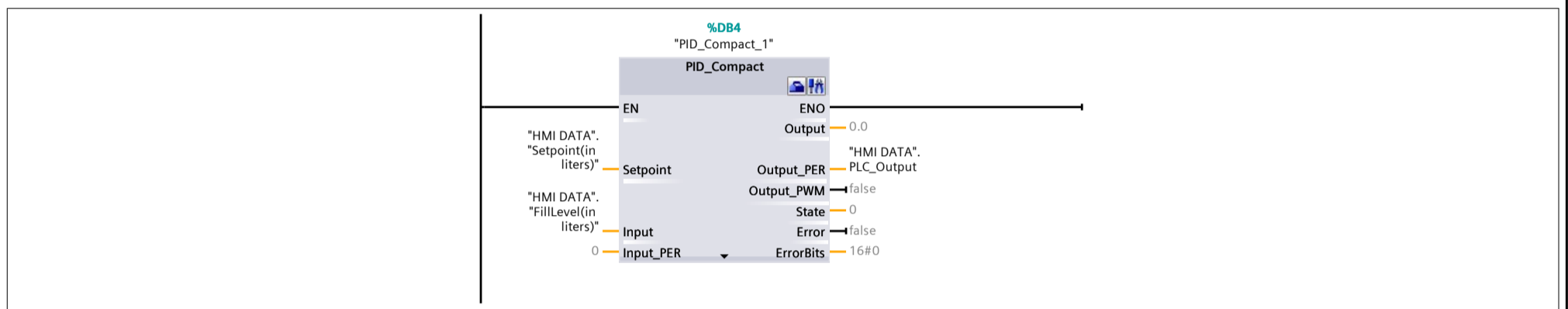

HMI visualization--- Faceplates / PLC_1 [CPU 1512C-1 PN] / Program blocks

Cyclic interrupt_TankLevel_PID_PWM [OB33]

Cyclic interrupt_TankLevel_PID_PWM Properties

General

Name	Cyclic interrupt_TankLevel_PID_PWM	Number	33	Type	OB	Language	LAD
-------------	------------------------------------	---------------	----	-------------	----	-----------------	-----

Numbering	Automatic
------------------	-----------

Information

Title		Author		Comment		Family	
Version	0.1	User-defined ID					

Name	Data type	Default value
▼ Input		
Initial_Call	Bool	
Event_Count	Int	
Temp		
Constant		

Network 1: PID controller for TANK2

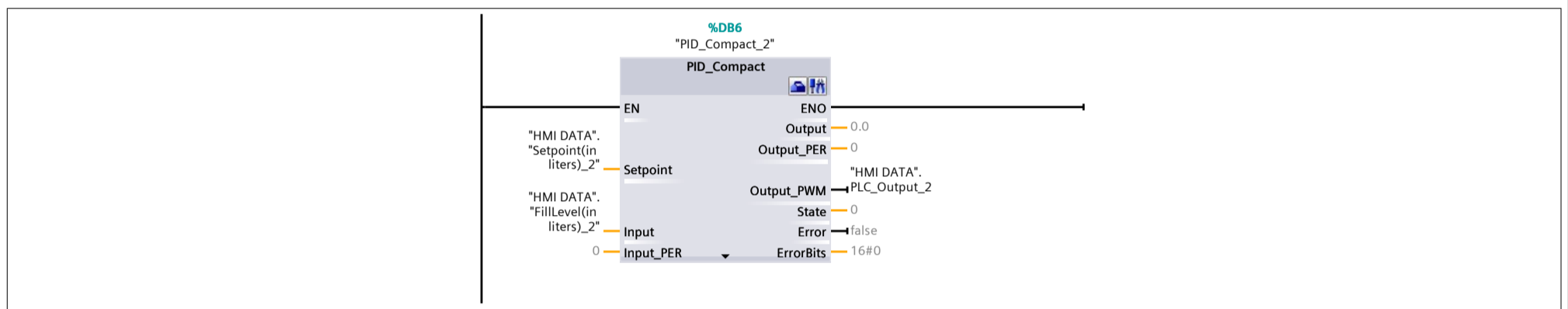

HMI visualization--- Faceplates / PLC_1 [CPU 1512C-1 PN] / Program blocks

Cyclic_interrupt_1ms_TANK1Simulation [OB32]

Cyclic_interrupt_1ms_TANK1Simulation Properties

General

Name	Cyclic_interrupt_1ms_TANK1Simulation	Number	32	Type	OB	Language	LAD
-------------	--------------------------------------	---------------	----	-------------	----	-----------------	-----

Numbering Automatic

Information

Title		Author		Comment		Family	
Version	0.1	User-defined ID					

Name	Data type	Default value
▼ Input		
Initial_Call	Bool	
Event_Count	Int	
Temp		
Constant		

Network 1: tank 1 simulator

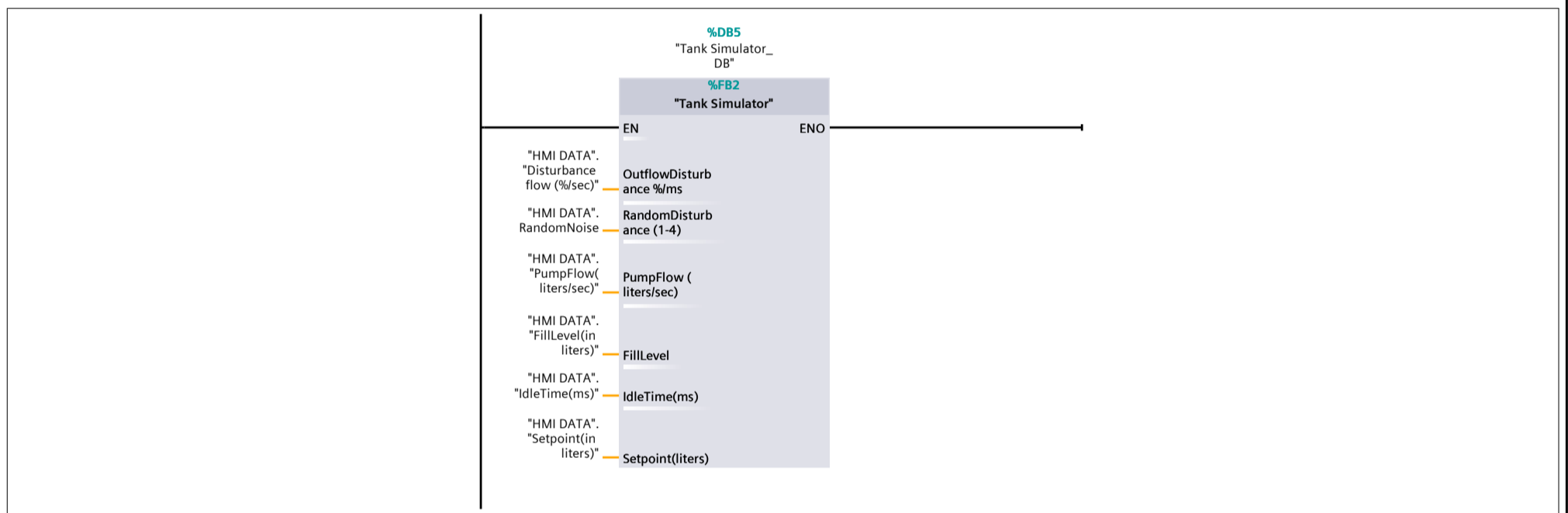

HMI visualization--- Faceplates / PLC_1 [CPU 1512C-1 PN] / Program blocks

Tank2 Simulator_DB [DB3]

Tank2 Simulator_DB Properties

General

Name	Tank2 Simulator_DB	Number	3	Type	DB	Language	DB
-------------	--------------------	---------------	---	-------------	----	-----------------	----

Numbering	Automatic
------------------	-----------

Information

Title		Author		Comment		Family	
--------------	--	---------------	--	----------------	--	---------------	--

Version	0.1	User-defined ID	
----------------	-----	------------------------	--

Name	Data type	Start value	Retain
▼ Input			
OutflowDisturbance %/ms	Real	0.0	False
RandomDisturbance (1-4)	Int	0	False
PumpFlow (liters/sec)	Real	0.0	False
Output			
▼ InOut			
FillLevel	Real	0.0	False
IdleTime(ms)	Int	0	False
Setpoint(liters)	Real	0.0	False
▼ Static			
Pump Output real (l/ms)	Real	0.0	False
Pump Memory	Array[0..9999] of Real		False
Pump Memory i	Int	0	False
Pump Memory Result	Real	0.0	False

HMI visualization--- Faceplates / PLC_1 [CPU 1512C-1 PN] / Program blocks / System blocks / Program resources

PID_Compact [FB1130]

PID_Compact Properties

General

Name	PID_Compact	Number	1130	Type	FB	Language	SCL
Numbering	Automatic						

Information

Title	Compact PID_Controller with self-tuning	Author	SIMATIC	Comment		Family	COMPPID
Version	2.4	User-defined ID	PID_Cmpt				

Name	Data type	Default value	Retain
▼ Input			
Setpoint	Real	0.0	Non-retain
Input	Real	0.0	Non-retain
Input_PER	Int	0	Non-retain
Disturbance	Real	0.0	Non-retain
ManualEnable	Bool	false	Non-retain
ManualValue	Real	0.0	Non-retain
ErrorAck	Bool	false	Non-retain
Reset	Bool	false	Non-retain
ModeActivate	Bool	false	Non-retain
▼ Output			
ScaledInput	Real	0.0	Non-retain
Output	Real	0.0	Non-retain
Output_PER	Int	0	Non-retain
Output_PWM	Bool	false	Non-retain
SetpointLimit_H	Bool	false	Non-retain
SetpointLimit_L	Bool	false	Non-retain
InputWarning_H	Bool	false	Non-retain
InputWarning_L	Bool	false	Non-retain
State	Int	0	Non-retain
Error	Bool	false	Non-retain
ErrorBits	DWord	16#0	Retain
▼ InOut			
Mode	Int	4	Retain
▼ Static			
InternalDiagnostic	DWord	0	Non-retain
InternalVersion	DWord	DW#16#02040001	Non-retain
InternalRTVersion	DWord	0	Non-retain
IntegralResetMode	Int	4	Non-retain
OverwriteInitialOutputValue	Real	0.0	Non-retain
RunModeByStartup	Bool	true	Non-retain
LoadBackUp	Bool	false	Non-retain
SetSubstituteOutput	Bool	true	Non-retain
PhysicalUnit	Int	0	Non-retain
PhysicalQuantity	Int	0	Non-retain
ActivateRecoverMode	Bool	true	Non-retain
Warning	DWord	16#0	Retain
WarningInternal	DWord	16#0	Retain
Progress	Real	0.0	Non-retain
CurrentSetpoint	Real	0.0	Non-retain
CancelTuningLevel	Real	10.0	Non-retain
SubstituteOutput	Real	0.0	Non-retain
Config	PID_CompactConfig		Non-retain
CycleTime	PID_CycleTime		Non-retain
CtrlParamsBackUp	PID_CompactControlParams		Non-retain
PIDSelfTune	PID_CompactSelfTune		Non-retain
PIDCtrl	PID_CompactControl		Non-retain
Retain	PID_CompactRetain		Retain

HMI visualization--- Faceplates / PLC_1 [CPU 1512C-1 PN] / Technology objects

PID_Compact_1 [DB4]

PID_Compact_1 Properties

General

Name	PID_Compact_1	Number	4	Type	DB	Language	DB
Numbering	Automatic						

Information

Title		Author	SIMATIC	Comment		Family	COMPPID
Version	2.4	User-defined ID	PID_Cmpt				

Name	Data type	Start value	Retain
▼ Input			
Setpoint	Real	0.0	False
Input	Real	0.0	False
Input_PER	Int	0	False
Disturbance	Real	0.0	False
ManualEnable	Bool	false	False
ManualValue	Real	0.0	False
ErrorAck	Bool	false	False
Reset	Bool	false	False
ModeActivate	Bool	false	False
▼ Output			
ScaledInput	Real	0.0	False
Output	Real	0.0	False
Output_PER	Int	0	False
Output_PWM	Bool	false	False
SetpointLimit_H	Bool	false	False
SetpointLimit_L	Bool	false	False
InputWarning_H	Bool	false	False
InputWarning_L	Bool	false	False
State	Int	0	False
Error	Bool	false	False
ErrorBits	DWord	16#0	True
▼ InOut			
Mode	Int	3	True
▼ Static			
InternalDiagnostic	DWord	0	False
InternalVersion	DWord	DW#16#02040001	False
InternalRTVersion	DWord	0	False
IntegralResetMode	Int	4	False
OverwriteInitialOutputValue	Real	0.0	False
RunModeByStartup	Bool	true	False
LoadBackUp	Bool	false	False
SetSubstituteOutput	Bool	true	False
PhysicalUnit	Int	0	False
PhysicalQuantity	Int	14	False
ActivateRecoverMode	Bool	true	False
Warning	DWord	16#0	True
WarningInternal	DWord	16#0	True
Progress	Real	0.0	False
CurrentSetpoint	Real	0.0	False
CancelTuningLevel	Real	10.0	False
SubstituteOutput	Real	0.0	False
Config	PID_CompactConfig		False
CycleTime	PID_CycleTime		False
CtrlParamsBackUp	PID_CompactControlParams		False
PIDSelfTune	PID_CompactSelfTune		False
PIDCtrl	PID_CompactControl		False
Retain	PID_CompactRetain		True

HMI visualization--- Faceplates / PLC_1 [CPU 1512C-1 PN] / Technology objects

PID_Compact_2 [DB6]

PID_Compact_2 Properties

General

Name	PID_Compact_2	Number	6	Type	DB	Language	DB
Numbering	Automatic						

Information

Title		Author	SIMATIC	Comment		Family	COMPPID
Version	2.4	User-defined ID	PID_Cmpt				

Name	Data type	Start value	Retain
▼ Input			
Setpoint	Real	0.0	False
Input	Real	0.0	False
Input_PER	Int	0	False
Disturbance	Real	0.0	False
ManualEnable	Bool	false	False
ManualValue	Real	0.0	False
ErrorAck	Bool	false	False
Reset	Bool	false	False
ModeActivate	Bool	false	False
▼ Output			
ScaledInput	Real	0.0	False
Output	Real	0.0	False
Output_PER	Int	0	False
Output_PWM	Bool	false	False
SetpointLimit_H	Bool	false	False
SetpointLimit_L	Bool	false	False
InputWarning_H	Bool	false	False
InputWarning_L	Bool	false	False
State	Int	0	False
Error	Bool	false	False
ErrorBits	DWord	16#0	True
▼ InOut			
Mode	Int	3	True
▼ Static			
InternalDiagnostic	DWord	0	False
InternalVersion	DWord	DW#16#02040001	False
InternalRTVersion	DWord	0	False
IntegralResetMode	Int	4	False
OverwriteInitialOutputValue	Real	0.0	False
RunModeByStartup	Bool	true	False
LoadBackUp	Bool	false	False
SetSubstituteOutput	Bool	true	False
PhysicalUnit	Int	0	False
PhysicalQuantity	Int	14	False
ActivateRecoverMode	Bool	true	False
Warning	DWord	16#0	True
WarningInternal	DWord	16#0	True
Progress	Real	0.0	False
CurrentSetpoint	Real	0.0	False
CancelTuningLevel	Real	10.0	False
SubstituteOutput	Real	0.0	False
Config	PID_CompactConfig		False
CycleTime	PID_CycleTime		False
CtrlParamsBackUp	PID_CompactControlParams		False
PIDSelfTune	PID_CompactSelfTune		False
PIDCtrl	PID_CompactControl		False
Retain	PID_CompactRetain		True

HMI visualization--- Faceplates / PLC_1 [CPU 1512C-1 PN]

PLC tags

PLC tags			
Icon	Name	Data type	Address

HMI visualization--- Faceplates / PLC_1 [CPU 1512C-1 PN] / PLC tags

Default tag table [63]

PLC tags			
Icon	Name	Data type	Address

HMI visualization--- Faceplates / PLC_1 [CPU 1512C-1 PN] / PLC data types / System data types

PID_CompactConfig

PID_CompactConfig Properties

General

Name	PID_CompactConfig	Number	1134	Type	UDT	Language	
-------------	-------------------	---------------	------	-------------	-----	-----------------	--

Numbering

Information

Title	configuration data set	Author		Comment		Family	
--------------	------------------------	---------------	--	----------------	--	---------------	--

Version		User-defined ID	
----------------	--	------------------------	--

Name	Data type	Default value
InputPerOn	Bool	true
InvertControl	Bool	false
InputUpperLimit	Real	120.0
InputLowerLimit	Real	0.0
InputUpperWarning	Real	3.402822e+38
InputLowerWarning	Real	-3.402822e+38
OutputUpperLimit	Real	100.0
OutputLowerLimit	Real	0.0
SetpointUpperLimit	Real	3.402822e+38
SetpointLowerLimit	Real	-3.402822e+38
MinimumOnTime	Real	0.0
MinimumOffTime	Real	0.0
InputScaling	PID_Scaling	

HMI visualization--- Faceplates / PLC_1 [CPU 1512C-1 PN] / PLC data types / System data types

PID_Scaling

PID_Scaling Properties

General

Name	PID_Scaling	Number	1135	Type	UDT	Language	
-------------	-------------	---------------	------	-------------	-----	-----------------	--

Numbering

Information

Title	data for scaling	Author		Comment		Family	
Version		User-defined ID					

Name	Data type	Default value
UpperPointIn	Real	27648.0
LowerPointIn	Real	0.0
UpperPointOut	Real	100.0
LowerPointOut	Real	0.0

HMI visualization--- Faceplates / PLC_1 [CPU 1512C-1 PN] / PLC data types / System data types

PID_CycleTime

PID_CycleTime Properties

General

Name	PID_CycleTime	Number	1137	Type	UDT	Language	
-------------	---------------	---------------	------	-------------	-----	-----------------	--

Numbering

Information

Title	data set for cycle time estimation	Author		Comment		Family	
--------------	------------------------------------	---------------	--	----------------	--	---------------	--

Version		User-defined ID	
----------------	--	------------------------	--

Name	Data type	Default value
StartEstimation	Bool	true
EnEstimation	Bool	true
EnMonitoring	Bool	true
Value	Real	0.1

HMI visualization--- Faceplates / PLC_1 [CPU 1512C-1 PN] / PLC data types / System data types

PID_CompactControlParams

PID_CompactControlParams Properties

General

Name	PID_CompactControlParams	Number	1138	Type	UDT	Language	
-------------	--------------------------	---------------	------	-------------	-----	-----------------	--

Numbering

Information

Title	controlling parameter set	Author		Comment		Family	
--------------	---------------------------	---------------	--	----------------	--	---------------	--

Version		User-defined ID	
----------------	--	------------------------	--

Name	Data type	Default value
Gain	Real	1.0
Ti	Real	20.0
Td	Real	0.0
TdFiltRatio	Real	0.2
PWeighting	Real	1.0
DWeighting	Real	1.0
Cycle	Real	1.0

HMI visualization--- Faceplates / PLC_1 [CPU 1512C-1 PN] / PLC data types / System data types

PID_CompactSelfTune

PID_CompactSelfTune Properties

General

Name	PID_CompactSelfTune	Number	1139	Type	UDT	Language	
-------------	---------------------	---------------	------	-------------	-----	-----------------	--

Numbering

Information

Title	data set for self tuning	Author		Comment		Family	
--------------	--------------------------	---------------	--	----------------	--	---------------	--

Version		User-defined ID	
----------------	--	------------------------	--

Name	Data type	Default value
SUT	PID_Compact_SUT	
TIR	PID_Compact_TIR	

HMI visualization--- Faceplates / PLC_1 [CPU 1512C-1 PN] / PLC data types / System data types

PID_GradientEstimation

PID_GradientEstimation Properties

General

Name	PID_GradientEstimation	Number	1508	Type	UDT	Language	
-------------	------------------------	---------------	------	-------------	-----	-----------------	--

Numbering

Information

Title	structure for gradient estimation	Author		Comment		Family	
--------------	-----------------------------------	---------------	--	----------------	--	---------------	--

Version		User-defined ID	
----------------	--	------------------------	--

Name	Data type	Default value
------	-----------	---------------

Name	Data type	Default value
------	-----------	---------------

HMI visualization--- Faceplates / PLC_1 [CPU 1512C-1 PN] / PLC data types / System data types

PID_StandardDeviation

PID_StandardDeviation Properties

General

Name	PID_StandardDeviation	Number	1509	Type	UDT	Language	
-------------	-----------------------	---------------	------	-------------	-----	-----------------	--

Numbering

Information

Title	data for estimation of deviation	Author		Comment		Family	
--------------	----------------------------------	---------------	--	----------------	--	---------------	--

Version		User-defined ID	
----------------	--	------------------------	--

Name	Data type	Default value
------	-----------	---------------

Name	Data type	Default value
------	-----------	---------------

HMI visualization--- Faceplates / PLC_1 [CPU 1512C-1 PN] / PLC data types / System data types

PID_Compact_SUT

PID_Compact_SUT Properties

General

Name	PID_Compact_SUT	Number	1142	Type	UDT	Language	
-------------	-----------------	---------------	------	-------------	-----	-----------------	--

Numbering

Information

Title	data set for start up tuning	Author		Comment		Family	
--------------	------------------------------	---------------	--	----------------	--	---------------	--

Version		User-defined ID	
----------------	--	------------------------	--

Name	Data type	Default value
CalculateParams	Bool	false
TuneRule	Int	0
State	Int	0

HMI visualization--- Faceplates / PLC_1 [CPU 1512C-1 PN] / PLC data types / System data types

PID_Compact_TIR

PID_Compact_TIR Properties

General

Name	PID_Compact_TIR	Number	1143	Type	UDT	Language	
-------------	-----------------	---------------	------	-------------	-----	-----------------	--

Numbering

Information

Title	data set for tuning in run	Author		Comment		Family	
--------------	----------------------------	---------------	--	----------------	--	---------------	--

Version		User-defined ID	
----------------	--	------------------------	--

Name	Data type	Default value
RunIn	Bool	false
CalculateParams	Bool	false
TuneRule	Int	0
State	Int	0

HMI visualization--- Faceplates / PLC_1 [CPU 1512C-1 PN] / PLC data types / System data types

PID_CompactControl

PID_CompactControl Properties

General

Name	PID_CompactControl	Number	1144	Type	UDT	Language	
-------------	--------------------	---------------	------	-------------	-----	-----------------	--

Numbering

Information

Title	data for controlling part	Author		Comment		Family	
--------------	---------------------------	---------------	--	----------------	--	---------------	--

Version		User-defined ID	
----------------	--	------------------------	--

Name	Data type	Default value
PIDInit	Bool	false
IntegralSum	Real	0.0

HMI visualization--- Faceplates / PLC_1 [CPU 1512C-1 PN] / PLC data types / System data types

PID_CompactRetain

PID_CompactRetain Properties

General

Name	PID_CompactRetain	Number	1145	Type	UDT	Language	
-------------	-------------------	---------------	------	-------------	-----	-----------------	--

Numbering

Information

Title	retain data	Author		Comment		Family	
--------------	-------------	---------------	--	----------------	--	---------------	--

Version		User-defined ID	
----------------	--	------------------------	--

Name	Data type	Default value
CtrlParams	PID_CompactControlParams	

HMI visualization--- Faceplates / PLC_1 [CPU 1512C-1 PN] / Watch and force tables

Force table

Name	Address	Display format	Force value
------	---------	----------------	-------------

HMI visualization--- Faceplates / PLC_1 [CPU 1512C-1 PN]

Traces

Name

HMI visualization--- Faceplates / PLC_1 [CPU 1512C-1 PN] / Traces

Measurements

This folder is empty.

HMI visualization--- Faceplates / PLC_1 [CPU 1512C-1 PN] / Traces

Combined measurements

Name

HMI visualization--- Faceplates / PLC_1 [CPU 1512C-1 PN] / OPC UA communication

Server interfaces

This folder is empty.

HMI visualization--- Faceplates / PLC_1 [CPU 1512C-1 PN] / OPC UA communication

Client interfaces

This folder is empty.

HMI visualization--- Faceplates / PLC_1 [CPU 1512C-1 PN] / PLC supervisions & alarms

Supervisions

This folder is empty.

HMI visualization--- Faceplates / PLC_1 [CPU 1512C-1 PN] / PLC supervisions & alarms

PLC alarms



























PLC alarms					
Name	Type	ID	Alarm text	Info text	Information only

Instrumentation Tools

























Totally Integrated Automation Portal

HMI visualization--- Faceplates / PLC_1 [CPU 1512C-1 PN] / PLC supervisions & alarms

System alarms

System alarms					
Name	Type	ID	Alarm text	Info text	Information only
 SDIAG_AL-CAT_SUBMO-DUL_MSG_0002	PLC alarm	1	Error: @1W%t#7W@ @5W%t#7W@ @6W%t#257K@ / @6W%t#258K@.@6W%t#259K@ @6W%t#262K@ @6W%t#263K@	Short name: @6W%t#260K@ Order number: @6W%t#265K@	True
 SDIAG_AL-CAT_MOD-UL_MSG_0003	PLC alarm	2	Error: @1W%t#7W@ @5W%t#7W@ @6W%t#257K@ / @6W%t#258K@ @6W%t#262K@ @6W%t#263K@	Short name: @6W%t#260K@ Order number: @6W%t#265K@	True
 SDIAG_AL-CAT_RACK_MSG_0004	PLC alarm	3	Error: @1W%t#7W@ @5W%t#7W@ @6W%t#257K@ @6W%t#262K@ @6W%t#263K@	Short name: @6W%t#260K@ Order number: @6W%t#265K@	True
 SDIAG_AL-CAT_DE-VICE_MSG_0005	PLC alarm	4	Error: @1W%t#7W@ @5W%t#7W@ @6W%t#257K@ @6W%t#262K@ @6W%t#263K@ @8W%t#7W@	Short name: @6W%t#260K@ Order number: @6W%t#265K@	True
 SDIAG_AL-CAT_IOSYS-TEM_MSG_0006	PLC alarm	5	Error: @1W%t#7W@ @5W%t#7W@ @6W%t#276K@ @6W%t#262K@ @6W%t#263K@ @8W%t#7W@	Short name: @6W%t#260K@ Order number: @6W%t#265K@	True
 SDIAG_AL-CAT_CPU_OST_MSG_000D	PLC alarm	6	CPU status message: @1W%t#7W@ @5W%t#7W@ @6W%t#257K@ / @6W%t#258K@ @6W%t#262K@ @6W%t#263K@ @8W%t#7W@	Short name: @6W%t#260K@ Order number: @6W%t#265K@	True
 SDIAG_AL-CAT_CPU_IN-FO_MSG_000F	PLC alarm	7	CPU info: @1W%t#7W@ @5W%t#7W@ @6W%t#257K@ / @6W%t#258K@ @6W%t#262K@ @6W%t#263K@ @8W%t#7W@	Short name: @6W%t#260K@ Order number: @6W%t#265K@	True
 SDIAG_AL-CAT_CPU_ERR_M SG_0010	PLC alarm	8	CPU error: @1W%t#7W@ @5W%t#7W@ @6W%t#257K@ / @6W%t#258K@ @6W%t#262K@ @6W%t#263K@ @8W%t#7W@	Short name: @6W%t#260K@ Order number: @6W%t#265K@	True
 SDIAG_AL-CAT_CPU_MD_M SG_0011	PLC alarm	9	CPU maintenance demanded: @1W%t#7W@ @6W%t#257K@ / @5W%t#7W@ @6W%t#258K@ @6W%t#262K@ @6W%t#263K@ @8W%t#7W@	Short name: @6W%t#260K@ Order number: @6W%t#265K@	True
 SDIAG_AL-CAT_CPU_MR_M SG1_0012	PLC alarm	10	CPU maintenance required: @1W%t#7W@ @6W%t#257K@ / @5W%t#7W@ @6W%t#258K@ @6W%t#262K@ @6W%t#263K@ @8W%t#7W@	Short name: @6W%t#260K@ Order number: @6W%t#265K@	True
 SDIAG_AL-CAT_CPU_TMPER R_MSG_0013	PLC alarm	11	Temporary CPU error: @1W%t#7W@ @5W%t#7W@ @6W%t#257K@ / @6W%t#258K@ @6W%t#262K@ @6W%t#263K@ @8W%t#7W@	Short name: @6W%t#260K@ Order number: @6W%t#265K@	True
 SDIAG_AL-CAT_CH_ERR_MS G_0015	PLC alarm	12	Error: @1W%t#7W@ on @8W%t#280K@ @6W%t#257K@ / @6W%t#258K@.@6W%t#259K@ @6W%t#262K@ @6W%t#263K@	Short name: @6W%t#260K@ Order number: @6W%t#265K@	True
 SDIAG_AL-CAT_ECH_ERR_M SG_0016	PLC alarm	13	Error: @1W%t#7W@ - @5W%t#7W@ on @8W%t#280K@ @6W%t#257K@ / @6W%t#258K@.@6W%t#259K@ @6W%t#262K@ @6W%t#263K@	Short name: @6W%t#260K@ Order number: @6W%t#265K@	True
 SDIAG_AL-CAT_CH_MD_MS G_0018	PLC alarm	14	Maintenance demanded:@1W%t#7W@ on @8W%t#280K@ @6W%t#257K@ / @6W%t#258K@.@6W%t#259K@ @6W%t#262K@ @6W%t#263K@	Short name: @6W%t#260K@ Order number: @6W%t#265K@	True
 SDIAG_AL-CAT_ECH_MD_M SG_0019	PLC alarm	15	Maintenance demanded:@1W%t#7W@ - @5W%t#7W@ on @8W%t#280K@ @6W%t#257K@ / @6W%t#258K@.@6W%t#259K@ @6W%t#262K@ @6W%t#263K@	Short name: @6W%t#260K@ Order number: @6W%t#265K@	True
 SDIAG_AL-CAT_CH_MR_MS G_001B	PLC alarm	16	Maintenance required:@1W%t#7W@ on @8W%t#280K@ @6W%t#257K@ / @6W%t#258K@.@6W%t#259K@ @6W%t#262K@ @6W%t#263K@	Short name: @6W%t#260K@ Order number: @6W%t#265K@	True
 SDIAG_AL-CAT_ECH_MR_M SG_001C	PLC alarm	17	Maintenance required:@1W%t#7W@ - @5W%t#7W@ on @8W%t#280K@ @6W%t#257K@ / @6W%t#258K@.@6W%t#259K@ @6W%t#262K@ @6W%t#263K@	Short name: @6W%t#260K@ Order number: @6W%t#265K@	True
 SDIAG_AL-CAT_SUB_ERR_M SG_001E	PLC alarm	18	Error: @1W%t#7W@ @6W%t#257K@ / @6W%t#258K@.@6W%t#259K@ @6W%t#262K@ @6W%t#263K@	Short name: @6W%t#260K@ Order number: @6W%t#265K@	True
 SDIAG_AL-CAT_ESUB_ERR_M SG_001F	PLC alarm	19	Error: @1W%t#7W@ - @5W%t#7W@ @6W%t#257K@ / @6W%t#258K@.@6W%t#259K@ @6W%t#262K@ @6W%t#263K@	Short name: @6W%t#260K@ Order number: @6W%t#265K@	True
 SDIAG_AL-CAT_SUB_MD_M SG_0021	PLC alarm	20	Maintenance demanded: @1W%t#7W@ @6W%t#257K@ / @6W%t#258K@.@6W%t#259K@ @6W%t#262K@ @6W%t#263K@	Short name: @6W%t#260K@ Order number: @6W%t#265K@	True
 SDIAG_AL-CAT_ESUB_MD_M SG_0022	PLC alarm	21	Maintenance demanded: @1W%t#7W@ - @5W%t#7W@ @6W%t#257K@ / @6W%t#258K@.@6W%t#259K@ @6W%t#262K@ @6W%t#263K@	Short name: @6W%t#260K@ Order number: @6W%t#265K@	True
 SDIAG_AL-CAT_SUB_MR_M SG_0024	PLC alarm	22	Maintenance required: @1W%t#7W@ @6W%t#257K@ / @6W%t#258K@.@6W%t#259K@ @6W%t#262K@ @6W%t#263K@	Short name: @6W%t#260K@ Order number: @6W%t#265K@	True
 SDIAG_AL-CAT_ESUB_MR_M SG_0025	PLC alarm	23	Maintenance required: @1W%t#7W@ - @5W%t#7W@ @6W%t#257K@ / @6W%t#258K@.@6W%t#259K@ @6W%t#262K@ @6W%t#263K@	Short name: @6W%t#260K@ Order number: @6W%t#265K@	True
 SDIAG_AL-CAT_CONFIG_IN-FO_0028	PLC alarm	24	Info: @1W%t#7W@ - @5W%t#7W@ @6W%t#257K@ @6W%t#262K@ @6W%t#263K@ @8W%t#7W@	Short name: @6W%t#260K@ Order number: @6W%t#265K@	True
 SDIAG_AL-CAT_CONFIG_RE-PORT_0029	PLC alarm	25	Info: @1W%t#7W@ - @5W%t#7W@ @6W%t#257K@ / @6W%t#258K@ @6W%t#262K@ @6W%t#263K@	Short name: @6W%t#260K@ Order number: @6W%t#265K@	True
 SDIAG_AL-CAT_SE-CU_EV_MSG_005E	PLC alarm	26	Security event: @1W%t#7W@ @5W%t#7W@ @6W%t#258K@ @6W%t#262K@ @6W%t#263K@ @8W%t#7W@	Short name: @6W%t#260K@ Order number: @6W%t#265K@	True
 SDIAG_AL-CAT_SE-CU_EV_IN-FO_005F	PLC alarm	27	Security information: @1W%t#7W@ @5W%t#7W@ @6W%t#258K@ @6W%t#262K@ @6W%t#263K@ @8W%t#7W@	Short name: @6W%t#260K@ Order number: @6W%t#265K@	True

Instrumentation Tools

Totally Integrated Automation Portal						
Name	Type	ID	Alarm text	Info text	Information only	
 SDIAG_AL-CAT_USER_MSG_0080	PLC alarm	28	User message: @1W%t#2W@	Short name: @6W%t#260K@ Order number: @6W%t#265K@	True	
 SDIAG_AL-CAT_PLC_MSG_00FF	PLC alarm	29	PLC notification: @1W%t#7W@ @5W%t#7W@ @6W%t#256K@ @6W%t#262K@ @6W%t#263K@	Short name: @6W%t#260K@ Order number: @6W%t#265K@	True	
 SDIAG_AL-CAT_SUBMODUL_MSG_0102	PLC alarm	30	Error: @1W%t#7W@ @5W%t#7W@ @6W%t#257K@ / @6W%t#258K@.@6W%t#259K@ @6W%t#262K@ @6W%t#263K@	Short name: @6W%t#260K@ Order number: @6W%t#265K@	False	
 SDIAG_AL-CAT_MODUL_MSG_0103	PLC alarm	31	Error: @1W%t#7W@ @5W%t#7W@ @6W%t#257K@ / @6W%t#258K@ @6W%t#262K@ @6W%t#263K@	Short name: @6W%t#260K@ Order number: @6W%t#265K@	False	
 SDIAG_AL-CAT_RACK_MSG_0104	PLC alarm	32	Error: @1W%t#7W@ @5W%t#7W@ @6W%t#257K@ @6W%t#262K@ @6W%t#263K@	Short name: @6W%t#260K@ Order number: @6W%t#265K@	False	
 SDIAG_AL-CAT_DEVICE_MSG_0105	PLC alarm	33	Error: @1W%t#7W@ @5W%t#7W@ @6W%t#257K@ @6W%t#262K@ @6W%t#263K@ @8W%t#7W@	Short name: @6W%t#260K@ Order number: @6W%t#265K@	False	
 SDIAG_AL-CAT_IOSYSTEM_MSG_0106	PLC alarm	34	Error: @1W%t#7W@ @5W%t#7W@ @6W%t#276K@ @6W%t#262K@ @6W%t#263K@ @8W%t#7W@	Short name: @6W%t#260K@ Order number: @6W%t#265K@	False	
 SDIAG_AL-CAT_CPU_OST_MSG_010D	PLC alarm	35	CPU status message: @1W%t#7W@ @5W%t#7W@ @6W%t#257K@ / @6W%t#258K@ @6W%t#262K@ @6W%t#263K@ @8W%t#7W@	Short name: @6W%t#260K@ Order number: @6W%t#265K@	False	
 SDIAG_AL-CAT_CPU_ERRMSG_0110	PLC alarm	36	CPU error: @1W%t#7W@ @5W%t#7W@ @6W%t#257K@ / @6W%t#258K@ @6W%t#262K@ @6W%t#263K@ @8W%t#7W@	Short name: @6W%t#260K@ Order number: @6W%t#265K@	False	
 SDIAG_AL-CAT_CPU_MDMSG_0111	PLC alarm	37	CPU maintenance demanded: @1W%t#7W@ @6W%t#257K@ / @5W%t#7W@ @6W%t#258K@ @6W%t#262K@ @6W%t#263K@ @8W%t#7W@	Short name: @6W%t#260K@ Order number: @6W%t#265K@	False	
 SDIAG_AL-CAT_CPU_MRMSG1_0112	PLC alarm	38	CPU maintenance required: @1W%t#7W@ @6W%t#257K@ / @5W%t#7W@ @6W%t#258K@ @6W%t#262K@ @6W%t#263K@ @8W%t#7W@	Short name: @6W%t#260K@ Order number: @6W%t#265K@	False	
 SDIAG_AL-CAT_CH_ERRMSG_0115	PLC alarm	39	Error: @1W%t#7W@ on @8W%t#280K@ @6W%t#257K@ / @6W%t#258K@.@6W%t#259K@ @6W%t#262K@ @6W%t#263K@	Short name: @6W%t#260K@ Order number: @6W%t#265K@	False	
 SDIAG_AL-CAT_ECH_ERRMSG_0116	PLC alarm	40	Error: @1W%t#7W@ - @5W%t#7W@ on @8W%t#280K@ @6W%t#257K@ / @6W%t#258K@.@6W%t#259K@ @6W%t#262K@ @6W%t#263K@	Short name: @6W%t#260K@ Order number: @6W%t#265K@	False	
 SDIAG_AL-CAT_CH_MDMSG_0118	PLC alarm	41	Maintenance demanded: @1W%t#7W@ on @8W%t#280K@ @6W%t#257K@ / @6W%t#258K@.@6W%t#259K@ @6W%t#262K@ @6W%t#263K@	Short name: @6W%t#260K@ Order number: @6W%t#265K@	False	
 SDIAG_AL-CAT_ECH_MDMSG_0119	PLC alarm	42	Maintenance demanded: @1W%t#7W@ - @5W%t#7W@ on @8W%t#280K@ @6W%t#257K@ / @6W%t#258K@.@6W%t#259K@ @6W%t#262K@ @6W%t#263K@	Short name: @6W%t#260K@ Order number: @6W%t#265K@	False	
 SDIAG_AL-CAT_CH_MRMSG_011B	PLC alarm	43	Maintenance required: @1W%t#7W@ on @8W%t#280K@ @6W%t#257K@ / @6W%t#258K@.@6W%t#259K@ @6W%t#262K@ @6W%t#263K@	Short name: @6W%t#260K@ Order number: @6W%t#265K@	False	
 SDIAG_AL-CAT_ECH_MRMSG_011C	PLC alarm	44	Maintenance required: @1W%t#7W@ - @5W%t#7W@ on @8W%t#280K@ @6W%t#257K@ / @6W%t#258K@.@6W%t#259K@ @6W%t#262K@ @6W%t#263K@	Short name: @6W%t#260K@ Order number: @6W%t#265K@	False	
 SDIAG_AL-CAT_SUB_ERRMSG_011E	PLC alarm	45	Error: @1W%t#7W@ @6W%t#257K@ / @6W%t#258K@.@6W%t#259K@ @6W%t#262K@ @6W%t#263K@	Short name: @6W%t#260K@ Order number: @6W%t#265K@	False	
 SDIAG_AL-CAT_ESUB_ERRMSG_011F	PLC alarm	46	Error: @1W%t#7W@ - @5W%t#7W@ @6W%t#257K@ / @6W%t#258K@.@6W%t#259K@ @6W%t#262K@ @6W%t#263K@	Short name: @6W%t#260K@ Order number: @6W%t#265K@	False	
 SDIAG_AL-CAT_SUB_MDMSG_0121	PLC alarm	47	Maintenance demanded: @1W%t#7W@ @6W%t#257K@ / @6W%t#258K@.@6W%t#259K@ @6W%t#262K@ @6W%t#263K@	Short name: @6W%t#260K@ Order number: @6W%t#265K@	False	
 SDIAG_AL-CAT_ESUB_MDMSG_0122	PLC alarm	48	Maintenance demanded: @1W%t#7W@ - @5W%t#7W@ @6W%t#257K@ / @6W%t#258K@.@6W%t#259K@ @6W%t#262K@ @6W%t#263K@	Short name: @6W%t#260K@ Order number: @6W%t#265K@	False	
 SDIAG_AL-CAT_SUB_MRMSG_0124	PLC alarm	49	Maintenance required: @1W%t#7W@ @6W%t#257K@ / @6W%t#258K@.@6W%t#259K@ @6W%t#262K@ @6W%t#263K@	Short name: @6W%t#260K@ Order number: @6W%t#265K@	False	
 SDIAG_AL-CAT_ESUB_MRMSG_0125	PLC alarm	50	Maintenance required: @1W%t#7W@ - @5W%t#7W@ @6W%t#257K@ / @6W%t#258K@.@6W%t#259K@ @6W%t#262K@ @6W%t#263K@	Short name: @6W%t#260K@ Order number: @6W%t#265K@	False	
 SDIAG_AL-CAT_CONFIG_INFO_0128	PLC alarm	51	Info: @1W%t#7W@ - @5W%t#7W@ @6W%t#257K@ @6W%t#262K@ @6W%t#263K@ @8W%t#7W@	Short name: @6W%t#260K@ Order number: @6W%t#265K@	False	
 SDIAG_AL-CAT_PLC_MSG_01FF	PLC alarm	52	PLC notification: @1W%t#7W@ @5W%t#7W@ @6W%t#256K@ @6W%t#262K@ @6W%t#263K@	Short name: @6W%t#260K@ Order number: @6W%t#265K@	False	

HMI visualization--- Faceplates / PLC_1 [CPU 1512C-1 PN]

PLC alarm text lists

This folder is empty.

HMI visualization--- Faceplates / PLC_1 [CPU 1512C-1 PN] / Local modules

PLC_1 [CPU 1512C-1 PN]

PLC_1

General\Project information

Name	PLC_1	Author	Mmuamed	Comment	
Rack	0	Slot	1		

General\Catalog information

Short designation	CPU 1512C-1 PN	Description	CPU with display; work memory 250 KB code and 1 MB data; 48 ns bit operation time; 4-stage protection concept, technology functions: motion control, closed-loop control, counting and measuring; tracing; Runtime options; for all PROFINET interfaces: transport protocol TCP/IP, secure Open User Communication, S7 communication, S7 routing, IP forwarding, Web server, DNS client, OPC UA: Server DA, Client DA, methods, companion specifications; PROFINET IO controller, supports RT/IRT, performance upgrade PROFINET V2.3, 2 ports, I-Device, MRP, MRPD, isochronous mode, Routing, runtime options; firmware V2.8 with DI32/DQ32, AI5/AQ2: Digital input module DI16 x DC24V, grouping 16; Digital output module DQ16 x DC24V/0.5A, grouping 16; Analog input module AI4 x U/I, AI 1xRTD, 16-bit, grouping 5; Analog output module AQ2 x U/I, 16-bit, grouping 2; 6 channels for counting and measuring with incremental encoders 24V (up to 100kHz); 4 channels for PTO, pulse width modulation, frequency output (up to 100kHz)	Article number	6ES7 512-1CK01-0AB0
Firmware version	V2.8				

General\Identification & Maintenance

Plant designation		Location identifier		Installation date	2023-08-07 08:58:52.401
Additional information					

General\Checksums

Text lists	FA 70 E8 75 1D 5A 8E 29	Software	C8 50 6F BC 2B E7 E9 2B
-------------------	-------------------------	-----------------	-------------------------

Connection resources\

	Station resources - Reserved - Maximum	Station resources - Reserved - Configured	Station resources - Dynamic - Configured	Module resources - PLC_1 [CPU 1512C-1 PN] - Configured
Maximum number of resources:	10	78	88	
	Maximum	Configured	Configured	Configured
PG communication:	4	-	-	-
HMI communication:	4	2	0	2
S7 communication:	0	-	0	0
Open user communication:	0	-	0	0
Web communication:	2	-	-	-
OPC UA client/server communication:	0	-	-	-
Other communication:	-	-	0	0
Total resources used:	2	0	2	
Available resources:	8	78	86	

Overview of addresses\Overview of addresses\Overview of addresses

Inputs	True	Outputs	True	Address gaps	False
Slot	True				

Instrumentation Tools

Totally Integrated Automation Portal											
Type	Addr. from	Addr. to	Module	PIP	OB	Device name	Device number	Size	Master / IO system	Rack	Slot
I	0	9	AI 5/AQ 2_1	Automatic update	-	PLC_1 [CPU 1512C-1 PN]	-	10 Bytes	-	0	1 8
O	0	3	AI 5/AQ 2_1	Automatic update	-	PLC_1 [CPU 1512C-1 PN]	-	4 Bytes	-	0	1 8
I	10	11	DI 16/DQ 16_1	Automatic update	-	PLC_1 [CPU 1512C-1 PN]	-	2 Bytes	-	0	1 9
O	4	5	DI 16/DQ 16_1	Automatic update	-	PLC_1 [CPU 1512C-1 PN]	-	2 Bytes	-	0	1 9
I	12	13	DI 16/DQ 16_2	Automatic update	-	PLC_1 [CPU 1512C-1 PN]	-	2 Bytes	-	0	1 10
O	6	7	DI 16/DQ 16_2	Automatic update	-	PLC_1 [CPU 1512C-1 PN]	-	2 Bytes	-	0	1 10
I	14	29	HSC_1	Automatic update	-	PLC_1 [CPU 1512C-1 PN]	-	16 Bytes	-	0	1 16
O	8	19	HSC_1	Automatic update	-	PLC_1 [CPU 1512C-1 PN]	-	12 Bytes	-	0	1 16
I	30	45	HSC_2	Automatic update	-	PLC_1 [CPU 1512C-1 PN]	-	16 Bytes	-	0	1 17
O	20	31	HSC_2	Automatic update	-	PLC_1 [CPU 1512C-1 PN]	-	12 Bytes	-	0	1 17
I	46	61	HSC_3	Automatic update	-	PLC_1 [CPU 1512C-1 PN]	-	16 Bytes	-	0	1 18
O	32	43	HSC_3	Automatic update	-	PLC_1 [CPU 1512C-1 PN]	-	12 Bytes	-	0	1 18
I	62	77	HSC_4	Automatic update	-	PLC_1 [CPU 1512C-1 PN]	-	16 Bytes	-	0	1 19
O	44	55	HSC_4	Automatic update	-	PLC_1 [CPU 1512C-1 PN]	-	12 Bytes	-	0	1 19
I	78	93	HSC_5	Automatic update	-	PLC_1 [CPU 1512C-1 PN]	-	16 Bytes	-	0	1 20
O	56	67	HSC_5	Automatic update	-	PLC_1 [CPU 1512C-1 PN]	-	12 Bytes	-	0	1 20
I	94	109	HSC_6	Automatic update	-	PLC_1 [CPU 1512C-1 PN]	-	16 Bytes	-	0	1 21
O	68	79	HSC_6	Automatic update	-	PLC_1 [CPU 1512C-1 PN]	-	12 Bytes	-	0	1 21
I	110	113	Pulse_1	Automatic update	-	PLC_1 [CPU 1512C-1 PN]	-	4 Bytes	-	0	1 32
O	80	91	Pulse_1	Automatic update	-	PLC_1 [CPU 1512C-1 PN]	-	12 Bytes	-	0	1 32
I	114	117	Pulse_2	Automatic update	-	PLC_1 [CPU 1512C-1 PN]	-	4 Bytes	-	0	1 33
O	92	103	Pulse_2	Automatic update	-	PLC_1 [CPU 1512C-1 PN]	-	12 Bytes	-	0	1 33
I	118	121	Pulse_3	Automatic update	-	PLC_1 [CPU 1512C-1 PN]	-	4 Bytes	-	0	1 34
O	104	115	Pulse_3	Automatic update	-	PLC_1 [CPU 1512C-1 PN]	-	12 Bytes	-	0	1 34
I	122	125	Pulse_4	Automatic update	-	PLC_1 [CPU 1512C-1 PN]	-	4 Bytes	-	0	1 35
O	116	127	Pulse_4	Automatic update	-	PLC_1 [CPU 1512C-1 PN]	-	12 Bytes	-	0	1 35

HMI visualization--- Faceplates

PC station [SIMATIC PC station]

This folder is empty.

HMI visualization--- Faceplates / PC station [SIMATIC PC station]

HMI_RT_1 [WinCC RT Advanced]

HMI_RT_1					
General					
Name	HMI_RT_1	Device/application type	SIMATIC PC station - WinCC RT Advanced	Author	Mmuhamed
Comment					
General\Catalog information					
Short designation	WinCC RT Advanced	Description	Runtime software for PC-based visualization (requires WinCC Runtime Advanced)	Article number	6AV2 104-0xxxx-xxxx
Version	16.0.0.0				
Information					
Number of used PowerTags	23	Memory requirements in runtime	112036	Compilation build number	34
Date of last compilation	8/19/2023 3:53 PM	Date of last download			

Instrumentation Tools

Totally Integrated Automation Portal						
HMI visualization--- Faceplates / PC station [SIMATIC PC station] / HMI_RT_1 [WinCC RT Advanced]						
Runtime settings						
General						
Start screen	Control	Load name information	Enabled	Default template		
Default style of the project	Disabled	Style of the HMI device	WinCC Fresh V 1.0.1	Adapt font size to style	Enabled	
Screen resolution	1280, 800	Full-screen mode	Disabled	Lock task switching	Disabled	
Project ID	0	Logging language	Startup language			
Services						
Sm@rtAccess or service: start Sm@rtServer	Disabled	Operate as OPC server	Disabled	OPC server type	OPC Unified Architecture Server	
Sm@rtAccess: SIMATIC HMI HTTP server	Disabled	Sm@rtAccess: Web service (SOAP)	Disabled	Sm@rtService: HTML pages	Disabled	
Name of SMTP server		Port	25	Name of the SMTP sender		
SMTP authentication		SMTP login		Secure connection for SMTP	Disabled	
Screens						
Bit selection for appearance analysis	Off	Bit selection for text and graphic lists	Off	Display limit values as a tooltip	Enabled	
Show script comments	Enabled	Scrolling mode	Scroll bar			
Keyboard						
Use screen keyboard	Disabled	Release button on exit	Disabled	Disable dialog window function keys	Disabled	
Good Manufacturing Practice						
Configuration conforms to GMP		Disabled				
Alarms						
Controller alarms						
Buffer overflow	10 %	Acknowledgment group text	QGR	Reporting	Enabled	
Use alarm class color	Disabled	Use help texts for system diagnostics	Enabled	System event duration	2 Seconds	
S7 diagnostic alarms with numbers only	Disabled	S7 diagnostic alarms with numbers and texts	Disabled	SIMOTION diagnostic alarms	Disabled	
Connection	HMI_Connection_1	Display classes	0-16			
User administration						
Change initial password	Disabled	Change logoff time	Enabled	Enable limit for logon attempts	Enabled	
Invalid logon attempts	3	Logon with password	Disabled	Group-specific rights	Disabled	
Password aging	Disabled	Validity period	90	Warning period	7	
Password generations	3	At least one special character	Disabled	At least one number	Disabled	
Minimum password length	3	SIMATIC Logon	Disabled	Apply user administration from	WinDomain	
Server name		Port number	16389	Windows domain		
Encrypted SIMATIC Logon	Enabled					
Language & font						
Preset runtime language		English (United States)				
English (United States)						
Runtime language	Enabled	Default font	Tahoma, 13 Pixel			
OPC settings						
OPC UA server port number	4870	OPC UA server URL	opc.tcp://[HostName]:4870		No OPC UA server security	Enabled
No OPC UA server security	Enabled	OPC UA server with 128-bit RSA cryptographic system	Enabled		OPC UA server with 128-bit RSA cryptographic system without signature	Disabled
OPC UA server with 128-bit RSA cryptographic system for signatures	Disabled	OPC UA server with 128-bit cryptographic system for signatures and encryption	Enabled			

Instrumentation Tools

Totally Integrated Automation Portal		
--------------------------------------	--	--

Tag settings

Replace the separators on each sub-level of the path of the PLC tag:	Enabled	Compatibility mode: Set '_' between the PLC tags and the first-level element.	Disabled	Replace the '.' character if the name of the HMI tag is created from the PLC tag name	Enabled
Use '_' as the replacement character	Enabled	Use ';' as the replacement character	Disabled	Replace the characters '[' and ']' if the name of the HMI tag is created from the PLC tag name	Enabled
Use '{' and '}' as replacement characters	Enabled	Use '(' and ')' as replacement characters	Disabled		

Settings for the prefix 'PLC' in the HMI tag name

Connection	HMI_Connection_1	PLC name as prefix in the HMI tag name	Disabled
------------	------------------	--	----------

HMI visualization--- Faceplates / PC station [SIMATIC PC station] / HMI_RT_1 [WinCC RT Advanced] / Screens Control

Hardcopy of Control

PID_Output

Set Point 100.000liters

Proportial gain 60000000

Integral gain 70000000

Deravative gain 80000000

OutFlow 2000.00%/sec

Disturbance 4OFF

Idle Time 30000ms

OUTPTUT 000.000%

Pump flow 000.000

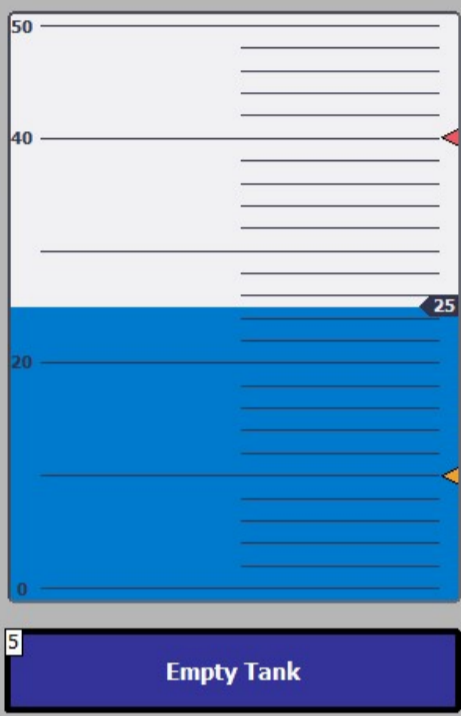

5
Empty Tank

PID_PWM

Set Point 900.000liters

Proportial gain 120000000

Integral gain 130000000

Deravative gain 140000000

OutFlow 150000000

Disturbance 10OFF

Idle Time 1600000

OUTPTUT 18

Pump flow 170000000

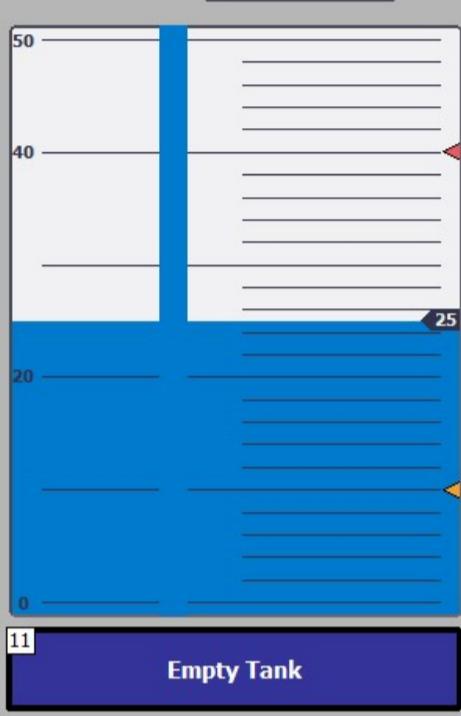

11
Empty Tank

Name	Control	Background color	182, 182, 182	Grid color	0, 0, 0
Number	1	Template		Tooltip	

Bar_1					
Type	Bar	Name	Bar_1	Y position	171
X position	272	Width	290	Height	378
Maximum value	50	Minimum value	0	Process value	0
Dynamizations\Tag connection					
Property name	Process value	Tag	HMI DATA_FillLevel(in liters)		

Text field_1					
Type	Text field	Name	Text field_1	X position	297
Y position	129	Width	73	Height	22
Layer	0 - Layer_0	Font	Tahoma, 15px, style=Bold	Text	Set Point

I/O field_1					
Type	I/O field	Name	I/O field_1	X position	397
Y position	124	Width	123	Height	32
Layer	0 - Layer_0	Mode	Input/output	Font	Tahoma, 15px, style=Bold
Dynamizations\Tag connection					
Property name	Process value	Tag	HMI DATA_Setpoint(in liters)		

Text field_3					
Type	Text field	Name	Text field_3	X position	29
Y position	358	Width	68	Height	22
Layer	0 - Layer_0	Font	Tahoma, 15px, style=Bold	Text	OutFlow

I/O field_3					
Type	I/O field	Name	I/O field_3	X position	126
Y position	352	Width	125	Height	32
Layer	0 - Layer_0	Mode	Input/output	Font	Tahoma, 15px, style=Bold
Dynamizations\Tag connection					
Property name	Process value	Tag	HMI DATA_Disturbance flow (%/sec)		

Text field_4					
Type	Text field	Name	Text field_4	X position	10
Y position	400	Width	95	Height	22

Instrumentation Tools

Totally Integrated Automation Portal					
Layer	0 - Layer_0	Font	Tahoma, 15px, style=Bold	Text	Disturbance
Text field_5					
Type	Text field	Name	Text field_5	X position	17
Y position	461	Width	75	Height	22
Layer	0 - Layer_0	Font	Tahoma, 15px, style=Bold	Text	Idle Time
I/O field_5					
Type	I/O field	Name	I/O field_5	X position	124
Y position	455	Width	125	Height	32
Layer	0 - Layer_0	Mode	Input/output	Font	Tahoma, 15px, style=Bold
Dynamizations\Tag connection					
Property name	Process value	Tag	HMI DATA_IdleTime(ms)		
Symbolic I/O field_2					
Type	Symbolic I/O field	Name	Symbolic I/O field_2	X position	125
Y position	396	Width	124	Height	35
Layer	0 - Layer_0	Mode	Input/output	Font	Tahoma, 15px, style=Bold
Text list	Random Disturbance				
Dynamizations\Tag connection					
Property name	Process value	Tag	HMI DATA_RandomNoise		
Button_1					
Type	Button	Name	Button_1	X position	270
Y position	565	Width	292	Height	54
Mode	Text	Text OFF	Empty Tank	Text ON	Text
Dynamizations\Event					
Event name	Press				
Function list\SetBitWhileKeyPressed					
Tag	HMI DATA_EmptyTank	Bit	0		
Text field_6					
Type	Text field	Name	Text field_6	X position	5
Y position	26	Width	556	Height	90
Layer	0 - Layer_0	Font	Tahoma, 36px, style=Bold	Text	PID_Output
Text field_2					
Type	Text field	Name	Text field_2	X position	12
Y position	182	Width	117	Height	22
Layer	0 - Layer_0	Font	Tahoma, 15px, style=Bold	Text	Proportial gain
Text field_7					
Type	Text field	Name	Text field_7	X position	12
Y position	226	Width	102	Height	22
Layer	0 - Layer_0	Font	Tahoma, 15px, style=Bold	Text	Integral gain
Text field_8					
Type	Text field	Name	Text field_8	X position	12
Y position	278	Width	124	Height	22
Layer	0 - Layer_0	Font	Tahoma, 15px, style=Bold	Text	Deravative gain
I/O field_8					
Type	I/O field	Name	I/O field_8	X position	107
Y position	529	Width	123	Height	32
Layer	0 - Layer_0	Mode	Output	Font	Tahoma, 15px, style=Bold
Dynamizations\Tag connection					
Property name	Process value	Tag	PID_Compact_1_Output		
Text field_10					
Type	Text field	Name	Text field_10	X position	17
Y position	534	Width	76	Height	22
Layer	0 - Layer_0	Font	Tahoma, 15px, style=Bold	Text	OUTPUTT
I/O field_9					
Type	I/O field	Name	I/O field_9	X position	107
Y position	568	Width	123	Height	32
Layer	0 - Layer_0	Mode	Output	Font	Tahoma, 15px, style=Bold
Dynamizations\Tag connection					
Property name	Process value	Tag	HMI DATA_PumpFlow(liters/sec)		
Text field_11					
Type	Text field	Name	Text field_11	X position	17
Y position	573	Width	83	Height	22
Layer	0 - Layer_0	Font	Tahoma, 15px, style=Bold	Text	Pump flow

Instrumentation Tools

Totally Integrated Automation Portal					
I/O field_2					
Type	I/O field	Name	I/O field_2	X position	162
Y position	169	Width	96	Height	32
Layer	0 - Layer_0	Mode	Input/output	Font	Tahoma, 15px, style=Bold
Dynamizations\Tag connection					
Property name	Process value	Tag	PID_Compact_1_Retain_CtrlParams_Gain		
I/O field_4					
Type	I/O field	Name	I/O field_4	X position	162
Y position	216	Width	96	Height	32
Layer	0 - Layer_0	Mode	Input/output	Font	Tahoma, 15px, style=Bold
Dynamizations\Tag connection					
Property name	Process value	Tag	PID_Compact_1_Retain_CtrlParams_Ti		
I/O field_6					
Type	I/O field	Name	I/O field_6	X position	162
Y position	274	Width	96	Height	32
Layer	0 - Layer_0	Mode	Input/output	Font	Tahoma, 15px, style=Bold
Dynamizations\Tag connection					
Property name	Process value	Tag	PID_Compact_1_Retain_CtrlParams_Td		
Text field_9					
Type	Text field	Name	Text field_9	X position	612
Y position	28	Width	646	Height	90
Layer	0 - Layer_0	Font	Tahoma, 36px, style=Bold	Text	PID_PWM
Bar_2					
Type	Bar	Name	Bar_2	Y position	180
X position	919	Width	290	Height	378
Maximum value	50	Minimum value	0	Process value	0
Dynamizations\Tag connection					
Property name	Process value	Tag	HMI DATA_FillLevel(in liters)_2		
Text field_12					
Type	Text field	Name	Text field_12	X position	944
Y position	138	Width	73	Height	22
Layer	0 - Layer_0	Font	Tahoma, 15px, style=Bold	Text	Set Point
I/O field_7					
Type	I/O field	Name	I/O field_7	X position	1044
Y position	133	Width	123	Height	32
Layer	0 - Layer_0	Mode	Input/output	Font	Tahoma, 15px, style=Bold
Dynamizations\Tag connection					
Property name	Process value	Tag	HMI DATA_Setpoint(in liters)_2		
Text field_13					
Type	Text field	Name	Text field_13	X position	689
Y position	385	Width	68	Height	22
Layer	0 - Layer_0	Font	Tahoma, 15px, style=Bold	Text	OutFlow
Text field_14					
Type	Text field	Name	Text field_14	X position	656
Y position	425	Width	95	Height	22
Layer	0 - Layer_0	Font	Tahoma, 15px, style=Bold	Text	Disturbance
Text field_15					
Type	Text field	Name	Text field_15	X position	656
Y position	480	Width	75	Height	22
Layer	0 - Layer_0	Font	Tahoma, 15px, style=Bold	Text	Idle Time
Symbolic I/O field_1					
Type	Symbolic I/O field	Name	Symbolic I/O field_1	X position	755
Y position	419	Width	124	Height	35
Layer	0 - Layer_0	Mode	Input/output	Font	Tahoma, 15px, style=Bold
Text list	Random Disturbance				
Dynamizations\Tag connection					
Property name	Process value	Tag	HMI DATA_RandomNoise_2		
Button_2					
Type	Button	Name	Button_2	X position	917
Y position	564	Width	292	Height	54
Mode	Text	Text OFF	Empty Tank	Text ON	Text
Dynamizations\Event					
Event name	Press				

Instrumentation Tools

Totally Integrated Automation Portal		
Function list\SetBitWhileKeyPressed		
Tag	HMI DATA_EmptyTank_2	Bit 0
Text field_16		
Type	Text field	Name Text field_16
Y position	185	Width 117
Layer	0 - Layer_0	Font Tahoma, 15px, style=Bold
		Text Proportial gain
Text field_17		
Type	Text field	Name Text field_17
Y position	233	Width 102
Layer	0 - Layer_0	Font Tahoma, 15px, style=Bold
		Text Integral gain
Text field_18		
Type	Text field	Name Text field_18
Y position	278	Width 124
Layer	0 - Layer_0	Font Tahoma, 15px, style=Bold
		Text Deravative gain
Text field_19		
Type	Text field	Name Text field_19
Y position	535	Width 76
Layer	0 - Layer_0	Font Tahoma, 15px, style=Bold
		Text OUTPUT
Text field_20		
Type	Text field	Name Text field_20
Y position	590	Width 83
Layer	0 - Layer_0	Font Tahoma, 15px, style=Bold
		Text Pump flow
I/O field_17		
Type	I/O field	Name I/O field_17
Y position	180	Width 96
Layer	0 - Layer_0	Mode Input/output
		Font Tahoma, 15px, style=Bold
Dynamizations\Tag connection		
Property name	Process value	Tag PID_Compact_2_Retain_CtrlParams_Gain
I/O field_14		
Type	I/O field	Name I/O field_14
Y position	231	Width 96
Layer	0 - Layer_0	Mode Input/output
		Font Tahoma, 15px, style=Bold
Dynamizations\Tag connection		
Property name	Process value	Tag PID_Compact_2_Retain_CtrlParams_Ti
I/O field_15		
Type	I/O field	Name I/O field_15
Y position	278	Width 96
Layer	0 - Layer_0	Mode Input/output
		Font Tahoma, 15px, style=Bold
Dynamizations\Tag connection		
Property name	Process value	Tag PID_Compact_2_Retain_CtrlParams_Td
I/O field_16		
Type	I/O field	Name I/O field_16
Y position	373	Width 96
Layer	0 - Layer_0	Mode Input/output
		Font Tahoma, 15px, style=Bold
Dynamization\Tag connection		
Property name	Process value	Tag HMI DATA_Disturbance flow (%/sec)_2
I/O field_10		
Type	I/O field	Name I/O field_10
Y position	476	Width 96
Layer	0 - Layer_0	Mode Input/output
		Font Tahoma, 15px, style=Bold
Dynamizations\Tag connection		
Property name	Process value	Tag HMI DATA_IdleTime(ms)_2
I/O field_11		
Type	I/O field	Name I/O field_11
Y position	585	Width 96
Layer	0 - Layer_0	Mode Input/output
		Font Tahoma, 15px, style=Bold
Dynamizations\Tag connection		
Property name	Process value	Tag HMI DATA_PumpFlow(liters/sec)_2
I/O field_13		
Type	I/O field	Name I/O field_13
Y position	532	Width 96
Layer	0 - Layer_0	Mode Input/output
		Font Tahoma, 15px, style=Bold
Dynamizations\Tag connection		
Property name	Process value	Tag PID_Compact_2_Output_PWM

Instrumentation Tools

Totally Integrated Automation Portal					
Rectangle_1					
Type	Rectangle	Name	Rectangle_1	X position	1015
Y position	180	Width	17	Height	376
Layer	0 - Layer_0	Background color	0, 122, 204	Border color	0, 122, 204
Dynamizations/Visibility					
Tag - Cycle	HMI DATA_PLC_Output_2 -	Data type	Range	Start range	1
End range	1	Visibility	Visible		

HMI visualization--- Faceplates / PC station [SIMATIC PC station] / HMI_RT_1 [WinCC RT Advanced] / Screens

FacePlates

Hardcopy of FacePlates



Name	FacePlates	Background color	182, 182, 182	Grid color	0, 0, 0
Number	2	Template		Tooltip	

Tank_1

Type	Faceplate	Name	Tank_1	X position	11
Y position	8	Width	210	Height	240

Tank_1\Rectangle_1

Type	Rectangle	Name	Rectangle_1	X position	10
Y position	10	Width	210	Height	240
Layer	0 - Layer_0	Background color	217, 217, 217	Border color	24, 28, 49

Tank_1\Text field_1

Type	Text field	Name	Text field_1	X position	91
Y position	20	Width	41	Height	22
Layer	0 - Layer_0	Font	Tahoma, 15px, style=Bold	Text	Tank

Tank_1\Bar_1

Type	Bar	Name	Bar_1	Y position	191
X position	21	Width	189	Height	47
Maximum value	100	Minimum value	0	Process value	0

Tank_1\Text field_2

Type	Text field	Name	Text field_2	X position	21
Y position	59	Width	73	Height	22
Layer	0 - Layer_0	Font	Tahoma, 15px, style=Bold	Text	Set Point

Tank_1\I/O field_1

Type	I/O field	Name	I/O field_1	X position	100
Y position	56	Width	114	Height	30
Layer	0 - Layer_0	Mode	Input/output	Font	Tahoma, 15px, style=Bold

Tank_1\Text field_3

Type	Text field	Name	Text field_3	X position	21
Y position	90	Width	68	Height	22
Layer	0 - Layer_0	Font	Tahoma, 15px, style=Bold	Text	OutFlow

Instrumentation Tools

Totally Integrated Automation Portal					
Tank_1\I/O field_3					
Type	I/O field	Name	I/O field_3	X position	100
Y position	86	Width	114	Height	32
Layer	0 - Layer_0	Mode	Input/output	Font	Tahoma, 15px, style=Bold
Tank_1\Button_1					
Type	Button	Name	Button_1	X position	40
Y position	130	Width	153	Height	43
Mode	Text	Text OFF	Empty Tank	Text ON	Text
Tank_2					
Type	Faceplate	Name	Tank_2	X position	233
Y position	8	Width	210	Height	240
Tank_2\Rectangle_1					
Type	Rectangle	Name	Rectangle_1	X position	10
Y position	10	Width	210	Height	240
Layer	0 - Layer_0	Background color	217, 217, 217	Border color	24, 28, 49
Tank_2\Text field_1					
Type	Text field	Name	Text field_1	X position	91
Y position	20	Width	41	Height	22
Layer	0 - Layer_0	Font	Tahoma, 15px, style=Bold	Text	Tank
Tank_2\Bar_1					
Type	Bar	Name	Bar_1	Y position	191
X position	21	Width	189	Height	47
Maximum value	100	Minimum value	0	Process value	0
Tank_2\Text field_2					
Type	Text field	Name	Text field_2	X position	21
Y position	59	Width	73	Height	22
Layer	0 - Layer_0	Font	Tahoma, 15px, style=Bold	Text	Set Point
Tank_2\I/O field_1					
Type	I/O field	Name	I/O field_1	X position	100
Y position	56	Width	114	Height	30
Layer	0 - Layer_0	Mode	Input/output	Font	Tahoma, 15px, style=Bold
Tank_2\Text field_3					
Type	Text field	Name	Text field_3	X position	21
Y position	90	Width	68	Height	22
Layer	0 - Layer_0	Font	Tahoma, 15px, style=Bold	Text	OutFlow
Tank_2\I/O field_3					
Type	I/O field	Name	I/O field_3	X position	100
Y position	86	Width	114	Height	32
Layer	0 - Layer_0	Mode	Input/output	Font	Tahoma, 15px, style=Bold
Tank_2\Button_1					
Type	Button	Name	Button_1	X position	40
Y position	130	Width	153	Height	43
Mode	Text	Text OFF	Empty Tank	Text ON	Text
Tank_3					
Type	Faceplate	Name	Tank_3	X position	455
Y position	9	Width	210	Height	240
Tank_3\Rectangle_1					
Type	Rectangle	Name	Rectangle_1	X position	10
Y position	10	Width	210	Height	240
Layer	0 - Layer_0	Background color	217, 217, 217	Border color	24, 28, 49
Tank_3\Text field_1					
Type	Text field	Name	Text field_1	X position	91
Y position	20	Width	41	Height	22
Layer	0 - Layer_0	Font	Tahoma, 15px, style=Bold	Text	Tank
Tank_3\Bar_1					
Type	Bar	Name	Bar_1	Y position	191
X position	21	Width	189	Height	47
Maximum value	100	Minimum value	0	Process value	0
Tank_3\Text field_2					
Type	Text field	Name	Text field_2	X position	21
Y position	59	Width	73	Height	22

Instrumentation Tools

Totally Integrated Automation Portal					
Layer	0 - Layer_0	Font	Tahoma, 15px, style=Bold	Text	Set Point
Tank_3\I/O field_1					
Type	I/O field	Name	I/O field_1	X position	100
Y position	56	Width	114	Height	30
Layer	0 - Layer_0	Mode	Input/output	Font	Tahoma, 15px, style=Bold
Tank_3\Text field_3					
Type	Text field	Name	Text field_3	X position	21
Y position	90	Width	68	Height	22
Layer	0 - Layer_0	Font	Tahoma, 15px, style=Bold	Text	OutFlow
Tank_3\I/O field_3					
Type	I/O field	Name	I/O field_3	X position	100
Y position	86	Width	114	Height	32
Layer	0 - Layer_0	Mode	Input/output	Font	Tahoma, 15px, style=Bold
Tank_3\Button_1					
Type	Button	Name	Button_1	X position	40
Y position	130	Width	153	Height	43
Mode	Text	Text OFF	Empty Tank	Text ON	Text
Tank_4					
Type	Faceplate	Name	Tank_4	X position	680
Y position	8	Width	210	Height	240
Tank_4\Rectangle_1					
Type	Rectangle	Name	Rectangle_1	X position	10
Y position	10	Width	210	Height	240
Layer	0 - Layer_0	Background color	217, 217, 217	Border color	24, 28, 49
Tank_4\Text field_1					
Type	Text field	Name	Text field_1	X position	91
Y position	20	Width	41	Height	22
Layer	0 - Layer_0	Font	Tahoma, 15px, style=Bold	Text	Tank
Tank_4\Bar_1					
Type	Bar	Name	Bar_1	Y position	191
X position	21	Width	189	Height	47
Maximum value	100	Minimum value	0	Process value	0
Tank_4\Text field_2					
Type	Text field	Name	Text field_2	X position	21
Y position	59	Width	73	Height	22
Layer	0 - Layer_0	Font	Tahoma, 15px, style=Bold	Text	Set Point
Tank_4\I/O field_1					
Type	I/O field	Name	I/O field_1	X position	100
Y position	56	Width	114	Height	30
Layer	0 - Layer_0	Mode	Input/output	Font	Tahoma, 15px, style=Bold
Tank_4\Text field_3					
Type	Text field	Name	Text field_3	X position	21
Y position	90	Width	68	Height	22
Layer	0 - Layer_0	Font	Tahoma, 15px, style=Bold	Text	OutFlow
Tank_4\I/O field_3					
Type	I/O field	Name	I/O field_3	X position	100
Y position	86	Width	114	Height	32
Layer	0 - Layer_0	Mode	Input/output	Font	Tahoma, 15px, style=Bold
Tank_4\Button_1					
Type	Button	Name	Button_1	X position	40
Y position	130	Width	153	Height	43
Mode	Text	Text OFF	Empty Tank	Text ON	Text
Tank_5					
Type	Faceplate	Name	Tank_5	X position	907
Y position	8	Width	210	Height	240
Tank_5\Rectangle_1					
Type	Rectangle	Name	Rectangle_1	X position	10
Y position	10	Width	210	Height	240
Layer	0 - Layer_0	Background color	217, 217, 217	Border color	24, 28, 49
Tank_5\Text field_1					
Type	Text field	Name	Text field_1	X position	91

Instrumentation Tools

Totally Integrated Automation Portal					
Y position	20	Width	41	Height	22
Layer	0 - Layer_0	Font	Tahoma, 15px, style=Bold	Text	Tank
Tank_5\Bar_1					
Type	Bar	Name	Bar_1	Y position	191
X position	21	Width	189	Height	47
Maximum value	100	Minimum value	0	Process value	0
Tank_5\Text field_2					
Type	Text field	Name	Text field_2	X position	21
Y position	59	Width	73	Height	22
Layer	0 - Layer_0	Font	Tahoma, 15px, style=Bold	Text	Set Point
Tank_5\I/O field_1					
Type	I/O field	Name	I/O field_1	X position	100
Y position	56	Width	114	Height	30
Layer	0 - Layer_0	Mode	Input/output	Font	Tahoma, 15px, style=Bold
Tank_5\Text field_3					
Type	Text field	Name	Text field_3	X position	21
Y position	90	Width	68	Height	22
Layer	0 - Layer_0	Font	Tahoma, 15px, style=Bold	Text	OutFlow
Tank_5\I/O field_3					
Type	I/O field	Name	I/O field_3	X position	100
Y position	86	Width	114	Height	32
Layer	0 - Layer_0	Mode	Input/output	Font	Tahoma, 15px, style=Bold
Tank_5\Button_1					
Type	Button	Name	Button_1	X position	40
Y position	130	Width	153	Height	43
Mode	Text	Text OFF	Empty Tank	Text ON	Text
Tank_6					
Type	Faceplate	Name	Tank_6	X position	11
Y position	261	Width	210	Height	240
Tank_6\Rectangle_1					
Type	Rectangle	Name	Rectangle_1	X position	10
Y position	10	Width	210	Height	240
Layer	0 - Layer_0	Background color	217, 217, 217	Border color	24, 28, 49
Tank_6\Text field_1					
Type	Text field	Name	Text field_1	X position	91
Y position	20	Width	41	Height	22
Layer	0 - Layer_0	Font	Tahoma, 15px, style=Bold	Text	Tank
Tank_6\Bar_1					
Type	Bar	Name	Bar_1	Y position	191
X position	21	Width	189	Height	47
Maximum value	100	Minimum value	0	Process value	0
Tank_6\Text field_2					
Type	Text field	Name	Text field_2	X position	21
Y position	59	Width	73	Height	22
Layer	0 - Layer_0	Font	Tahoma, 15px, style=Bold	Text	Set Point
Tank_6\I/O field_1					
Type	I/O field	Name	I/O field_1	X position	100
Y position	56	Width	114	Height	30
Layer	0 - Layer_0	Mode	Input/output	Font	Tahoma, 15px, style=Bold
Tank_6\Text field_3					
Type	Text field	Name	Text field_3	X position	21
Y position	90	Width	68	Height	22
Layer	0 - Layer_0	Font	Tahoma, 15px, style=Bold	Text	OutFlow
Tank_6\I/O field_3					
Type	I/O field	Name	I/O field_3	X position	100
Y position	86	Width	114	Height	32
Layer	0 - Layer_0	Mode	Input/output	Font	Tahoma, 15px, style=Bold
Tank_6\Button_1					
Type	Button	Name	Button_1	X position	40
Y position	130	Width	153	Height	43
Mode	Text	Text OFF	Empty Tank	Text ON	Text

Instrumentation Tools

Totally Integrated Automation Portal					
Tank_7					
Type	Faceplate	Name	Tank_7	X position	233
Y position	261	Width	210	Height	240
Tank_7\Rectangle_1					
Type	Rectangle	Name	Rectangle_1	X position	10
Y position	10	Width	210	Height	240
Layer	0 - Layer_0	Background color	217, 217, 217	Border color	24, 28, 49
Tank_7\Text field_1					
Type	Text field	Name	Text field_1	X position	91
Y position	20	Width	41	Height	22
Layer	0 - Layer_0	Font	Tahoma, 15px, style=Bold	Text	Tank
Tank_7\Bar_1					
Type	Bar	Name	Bar_1	Y position	191
X position	21	Width	189	Height	47
Maximum value	100	Minimum value	0	Process value	0
Tank_7\Text field_2					
Type	Text field	Name	Text field_2	X position	21
Y position	59	Width	73	Height	22
Layer	0 - Layer_0	Font	Tahoma, 15px, style=Bold	Text	Set Point
Tank_7\I/O field_1					
Type	I/O field	Name	I/O field_1	X position	100
Y position	56	Width	114	Height	30
Layer	0 - Layer_0	Mode	Input/output	Font	Tahoma, 15px, style=Bold
Tank_7\Text field_3					
Type	Text field	Name	Text field_3	X position	21
Y position	90	Width	68	Height	22
Layer	0 - Layer_0	Font	Tahoma, 15px, style=Bold	Text	OutFlow
Tank_7\I/O field_3					
Type	I/O field	Name	I/O field_3	X position	100
Y position	86	Width	114	Height	32
Layer	0 - Layer_0	Mode	Input/output	Font	Tahoma, 15px, style=Bold
Tank_7\Button_1					
Type	Button	Name	Button_1	X position	40
Y position	130	Width	153	Height	43
Mode	Text	Text OFF	Empty Tank	Text ON	Text
Tank_8					
Type	Faceplate	Name	Tank_8	X position	455
Y position	262	Width	210	Height	240
Tank_8\Rectangle_1					
Type	Rectangle	Name	Rectangle_1	X position	10
Y position	10	Width	210	Height	240
Layer	0 - Layer_0	Background color	217, 217, 217	Border color	24, 28, 49
Tank_8\Text field_1					
Type	Text field	Name	Text field_1	X position	91
Y position	20	Width	41	Height	22
Layer	0 - Layer_0	Font	Tahoma, 15px, style=Bold	Text	Tank
Tank_8\Bar_1					
Type	Bar	Name	Bar_1	Y position	191
X position	21	Width	189	Height	47
Maximum value	100	Minimum value	0	Process value	0
Tank_8\Text field_2					
Type	Text field	Name	Text field_2	X position	21
Y position	59	Width	73	Height	22
Layer	0 - Layer_0	Font	Tahoma, 15px, style=Bold	Text	Set Point
Tank_8\I/O field_1					
Type	I/O field	Name	I/O field_1	X position	100
Y position	56	Width	114	Height	30
Layer	0 - Layer_0	Mode	Input/output	Font	Tahoma, 15px, style=Bold
Tank_8\Text field_3					
Type	Text field	Name	Text field_3	X position	21
Y position	90	Width	68	Height	22

Instrumentation Tools

Totally Integrated Automation Portal					
Layer	0 - Layer_0	Font	Tahoma, 15px, style=Bold	Text	OutFlow
Tank_8\I/O field_3					
Type	I/O field	Name	I/O field_3	X position	100
Y position	86	Width	114	Height	32
Layer	0 - Layer_0	Mode	Input/output	Font	Tahoma, 15px, style=Bold
Tank_8\Button_1					
Type	Button	Name	Button_1	X position	40
Y position	130	Width	153	Height	43
Mode	Text	Text OFF	Empty Tank	Text ON	Text
Tank_9					
Type	Faceplate	Name	Tank_9	X position	681
Y position	262	Width	210	Height	240
Tank_9\Rectangle_1					
Type	Rectangle	Name	Rectangle_1	X position	10
Y position	10	Width	210	Height	240
Layer	0 - Layer_0	Background color	217, 217, 217	Border color	24, 28, 49
Tank_9\Text field_1					
Type	Text field	Name	Text field_1	X position	91
Y position	20	Width	41	Height	22
Layer	0 - Layer_0	Font	Tahoma, 15px, style=Bold	Text	Tank
Tank_9\Bar_1					
Type	Bar	Name	Bar_1	Y position	191
X position	21	Width	189	Height	47
Maximum value	100	Minimum value	0	Process value	0
Tank_9\Text field_2					
Type	Text field	Name	Text field_2	X position	21
Y position	59	Width	73	Height	22
Layer	0 - Layer_0	Font	Tahoma, 15px, style=Bold	Text	Set Point
Tank_9\I/O field_1					
Type	I/O field	Name	I/O field_1	X position	100
Y position	56	Width	114	Height	30
Layer	0 - Layer_0	Mode	Input/output	Font	Tahoma, 15px, style=Bold
Tank_9\Text field_3					
Type	Text field	Name	Text field_3	X position	21
Y position	90	Width	68	Height	22
Layer	0 - Layer_0	Font	Tahoma, 15px, style=Bold	Text	OutFlow
Tank_9\I/O field_3					
Type	I/O field	Name	I/O field_3	X position	100
Y position	86	Width	114	Height	32
Layer	0 - Layer_0	Mode	Input/output	Font	Tahoma, 15px, style=Bold
Tank_9\Button_1					
Type	Button	Name	Button_1	X position	40
Y position	130	Width	153	Height	43
Mode	Text	Text OFF	Empty Tank	Text ON	Text
Tank_10					
Type	Faceplate	Name	Tank_10	X position	908
Y position	262	Width	210	Height	240
Tank_10\Rectangle_1					
Type	Rectangle	Name	Rectangle_1	X position	10
Y position	10	Width	210	Height	240
Layer	0 - Layer_0	Background color	217, 217, 217	Border color	24, 28, 49
Tank_10\Text field_1					
Type	Text field	Name	Text field_1	X position	91
Y position	20	Width	41	Height	22
Layer	0 - Layer_0	Font	Tahoma, 15px, style=Bold	Text	Tank
Tank_10\Bar_1					
Type	Bar	Name	Bar_1	Y position	191
X position	21	Width	189	Height	47
Maximum value	100	Minimum value	0	Process value	0
Tank_10\Text field_2					
Type	Text field	Name	Text field_2	X position	21

Instrumentation Tools

Totally Integrated Automation Portal					
Y position	59	Width	73	Height	22
Layer	0 - Layer_0	Font	Tahoma, 15px, style=Bold	Text	Set Point
Tank_10\I/O field_1					
Type	I/O field	Name	I/O field_1	X position	100
Y position	56	Width	114	Height	30
Layer	0 - Layer_0	Mode	Input/output	Font	Tahoma, 15px, style=Bold
Tank_10\Text field_3					
Type	Text field	Name	Text field_3	X position	21
Y position	90	Width	68	Height	22
Layer	0 - Layer_0	Font	Tahoma, 15px, style=Bold	Text	OutFlow
Tank_10\I/O field_3					
Type	I/O field	Name	I/O field_3	X position	100
Y position	86	Width	114	Height	32
Layer	0 - Layer_0	Mode	Input/output	Font	Tahoma, 15px, style=Bold
Tank_10\Button_1					
Type	Button	Name	Button_1	X position	40
Y position	130	Width	153	Height	43
Mode	Text	Text OFF	Empty Tank	Text ON	Text
Tank_11					
Type	Faceplate	Name	Tank_11	X position	457
Y position	519	Width	210	Height	240
Tank_11\Rectangle_1					
Type	Rectangle	Name	Rectangle_1	X position	10
Y position	10	Width	210	Height	240
Layer	0 - Layer_0	Background color	217, 217, 217	Border color	24, 28, 49
Tank_11\Text field_1					
Type	Text field	Name	Text field_1	X position	91
Y position	20	Width	41	Height	22
Layer	0 - Layer_0	Font	Tahoma, 15px, style=Bold	Text	Tank
Tank_11\Bar_1					
Type	Bar	Name	Bar_1	Y position	191
X position	21	Width	189	Height	47
Maximum value	100	Minimum value	0	Process value	0
Tank_11\Text field_2					
Type	Text field	Name	Text field_2	X position	21
Y position	59	Width	73	Height	22
Layer	0 - Layer_0	Font	Tahoma, 15px, style=Bold	Text	Set Point
Tank_11\I/O field_1					
Type	I/O field	Name	I/O field_1	X position	100
Y position	56	Width	114	Height	30
Layer	0 - Layer_0	Mode	Input/output	Font	Tahoma, 15px, style=Bold
Tank_11\Text field_3					
Type	Text field	Name	Text field_3	X position	21
Y position	90	Width	68	Height	22
Layer	0 - Layer_0	Font	Tahoma, 15px, style=Bold	Text	OutFlow
Tank_11\I/O field_3					
Type	I/O field	Name	I/O field_3	X position	100
Y position	86	Width	114	Height	32
Layer	0 - Layer_0	Mode	Input/output	Font	Tahoma, 15px, style=Bold
Tank_11\Button_1					
Type	Button	Name	Button_1	X position	40
Y position	130	Width	153	Height	43
Mode	Text	Text OFF	Empty Tank	Text ON	Text
Tank_12					
Type	Faceplate	Name	Tank_12	X position	683
Y position	519	Width	210	Height	240
Tank_12\Rectangle_1					
Type	Rectangle	Name	Rectangle_1	X position	10
Y position	10	Width	210	Height	240
Layer	0 - Layer_0	Background color	217, 217, 217	Border color	24, 28, 49

Instrumentation Tools

Totally Integrated Automation Portal					
Tank_12\Text field_1					
Type	Text field	Name	Text field_1	X position	91
Y position	20	Width	41	Height	22
Layer	0 - Layer_0	Font	Tahoma, 15px, style=Bold	Text	Tank
Tank_12\Bar_1					
Type	Bar	Name	Bar_1	Y position	191
X position	21	Width	189	Height	47
Maximum value	100	Minimum value	0	Process value	0
Tank_12\Text field_2					
Type	Text field	Name	Text field_2	X position	21
Y position	59	Width	73	Height	22
Layer	0 - Layer_0	Font	Tahoma, 15px, style=Bold	Text	Set Point
Tank_12\I/O field_1					
Type	I/O field	Name	I/O field_1	X position	100
Y position	56	Width	114	Height	30
Layer	0 - Layer_0	Mode	Input/output	Font	Tahoma, 15px, style=Bold
Tank_12\Text field_3					
Type	Text field	Name	Text field_3	X position	21
Y position	90	Width	68	Height	22
Layer	0 - Layer_0	Font	Tahoma, 15px, style=Bold	Text	OutFlow
Tank_12\I/O field_3					
Type	I/O field	Name	I/O field_3	X position	100
Y position	86	Width	114	Height	32
Layer	0 - Layer_0	Mode	Input/output	Font	Tahoma, 15px, style=Bold
Tank_12\Button_1					
Type	Button	Name	Button_1	X position	40
Y position	130	Width	153	Height	43
Mode	Text	Text OFF	Empty Tank	Text ON	Text
Tank_13					
Type	Faceplate	Name	Tank_13	X position	910
Y position	519	Width	210	Height	240
Tank_13\Rectangle_1					
Type	Rectangle	Name	Rectangle_1	X position	10
Y position	10	Width	210	Height	240
Layer	0 - Layer_0	Background color	217, 217, 217	Border color	24, 28, 49
Tank_13\Text field_1					
Type	Text field	Name	Text field_1	X position	91
Y position	20	Width	41	Height	22
Layer	0 - Layer_0	Font	Tahoma, 15px, style=Bold	Text	Tank
Tank_13\Bar_1					
Type	Bar	Name	Bar_1	Y position	191
X position	21	Width	189	Height	47
Maximum value	100	Minimum value	0	Process value	0
Tank_13\Text field_2					
Type	Text field	Name	Text field_2	X position	21
Y position	59	Width	73	Height	22
Layer	0 - Layer_0	Font	Tahoma, 15px, style=Bold	Text	Set Point
Tank_13\I/O field_1					
Type	I/O field	Name	I/O field_1	X position	100
Y position	56	Width	114	Height	30
Layer	0 - Layer_0	Mode	Input/output	Font	Tahoma, 15px, style=Bold
Tank_13\Text field_3					
Type	Text field	Name	Text field_3	X position	21
Y position	90	Width	68	Height	22
Layer	0 - Layer_0	Font	Tahoma, 15px, style=Bold	Text	OutFlow
Tank_13\I/O field_3					
Type	I/O field	Name	I/O field_3	X position	100
Y position	86	Width	114	Height	32
Layer	0 - Layer_0	Mode	Input/output	Font	Tahoma, 15px, style=Bold
Tank_13\Button_1					
Type	Button	Name	Button_1	X position	40

Instrumentation Tools

Totally Integrated Automation Portal					
Y position	130	Width	153	Height	43
Mode	Text	Text OFF	Empty Tank	Text ON	Text
Tank_14					
Type	Faceplate	Name	Tank_14	X position	14
Y position	519	Width	210	Height	240
Tank_14\Rectangle_1					
Type	Rectangle	Name	Rectangle_1	X position	10
Y position	10	Width	210	Height	240
Layer	0 - Layer_0	Background color	217, 217, 217	Border color	24, 28, 49
Tank_14\Text field_1					
Type	Text field	Name	Text field_1	X position	91
Y position	20	Width	41	Height	22
Layer	0 - Layer_0	Font	Tahoma, 15px, style=Bold	Text	Tank
Tank_14\Bar_1					
Type	Bar	Name	Bar_1	Y position	191
X position	21	Width	189	Height	47
Maximum value	100	Minimum value	0	Process value	0
Tank_14\Text field_2					
Type	Text field	Name	Text field_2	X position	21
Y position	59	Width	73	Height	22
Layer	0 - Layer_0	Font	Tahoma, 15px, style=Bold	Text	Set Point
Tank_14\I/O field_1					
Type	I/O field	Name	I/O field_1	X position	100
Y position	56	Width	114	Height	30
Layer	0 - Layer_0	Mode	Input/output	Font	Tahoma, 15px, style=Bold
Tank_14\Text field_3					
Type	Text field	Name	Text field_3	X position	21
Y position	90	Width	68	Height	22
Layer	0 - Layer_0	Font	Tahoma, 15px, style=Bold	Text	OutFlow
Tank_14\I/O field_3					
Type	I/O field	Name	I/O field_3	X position	100
Y position	86	Width	114	Height	32
Layer	0 - Layer_0	Mode	Input/output	Font	Tahoma, 15px, style=Bold
Tank_14\Button_1					
Type	Button	Name	Button_1	X position	40
Y position	130	Width	153	Height	43
Mode	Text	Text OFF	Empty Tank	Text ON	Text
Tank_15					
Type	Faceplate	Name	Tank_15	X position	236
Y position	519	Width	210	Height	240
Tank_15\Rectangle_1					
Type	Rectangle	Name	Rectangle_1	X position	10
Y position	10	Width	210	Height	240
Layer	0 - Layer_0	Background color	217, 217, 217	Border color	24, 28, 49
Tank_15\Text field_1					
Type	Text field	Name	Text field_1	X position	91
Y position	20	Width	41	Height	22
Layer	0 - Layer_0	Font	Tahoma, 15px, style=Bold	Text	Tank
Tank_15\Bar_1					
Type	Bar	Name	Bar_1	Y position	191
X position	21	Width	189	Height	47
Maximum value	100	Minimum value	0	Process value	0
Tank_15\Text field_2					
Type	Text field	Name	Text field_2	X position	21
Y position	59	Width	73	Height	22
Layer	0 - Layer_0	Font	Tahoma, 15px, style=Bold	Text	Set Point
Tank_15\I/O field_1					
Type	I/O field	Name	I/O field_1	X position	100
Y position	56	Width	114	Height	30
Layer	0 - Layer_0	Mode	Input/output	Font	Tahoma, 15px, style=Bold

Instrumentation Tools

Totally Integrated Automation Portal		
--------------------------------------	--	--

Tank_15\Text field_3

Type	Text field	Name	Text field_3	X position	21	
Y position	90	Width	68	Height	22	
Layer	0 - Layer_0	Font	Tahoma, 15px, style=Bold		Text	OutFlow

Tank_15\I/O field_3

Type	I/O field	Name	I/O field_3	X position	100	
Y position	86	Width	114	Height	32	
Layer	0 - Layer_0	Mode	Input/output		Font	Tahoma, 15px, style=Bold

Tank_15\Button_1

Type	Button	Name	Button_1	X position	40	
Y position	130	Width	153	Height	43	
Mode	Text	Text OFF	Empty Tank		Text ON	Text

--	--	--

HMI visualization--- Faceplates / PC station [SIMATIC PC station] / HMI_RT_1 [WinCC RT Advanced] /
Screen management

Templates

This folder is empty.

Instrumentation Tools

Totally Integrated
Automation Portal

HMI visualization--- Faceplates / PC station [SIMATIC PC station] / HMI_RT_1 [WinCC RT Advanced] /
Screen management

Pop-up screens

This folder is empty.

Instrumentation Tools

Totally Integrated
Automation Portal

HMI visualization--- Faceplates / PC station [SIMATIC PC station] / HMI_RT_1 [WinCC RT Advanced] /
Screen management / Slide-in screens

Slide-in screen bottom

Hardcopy of Slide-in screen bottom

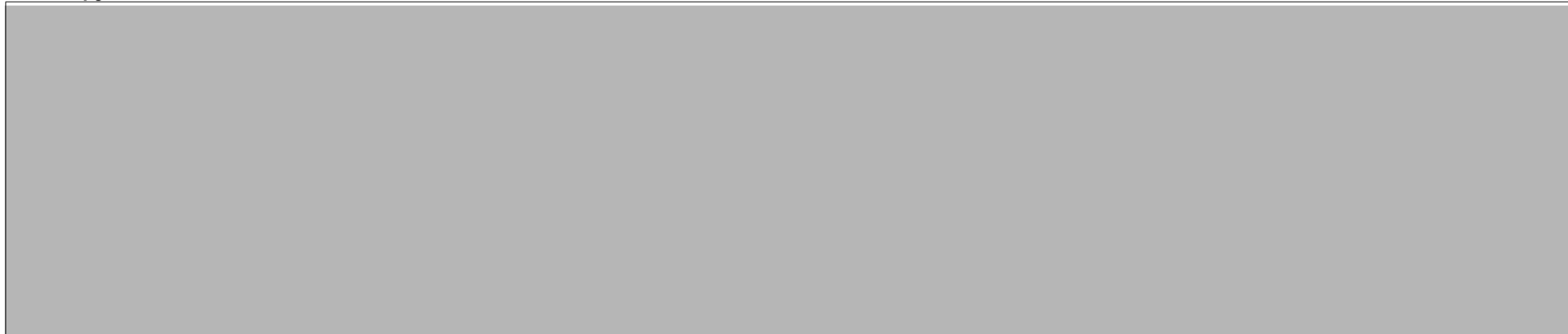

Name	Slide-in screen bottom	Activate slide-in screen	Disabled	Width	1280
Height	267	Active layer	0		

HMI visualization--- Faceplates / PC station [SIMATIC PC station] / HMI_RT_1 [WinCC RT Advanced] / Screen management / Slide-in screens

Slide-in screen left

Hardcopy of Slide-in screen left

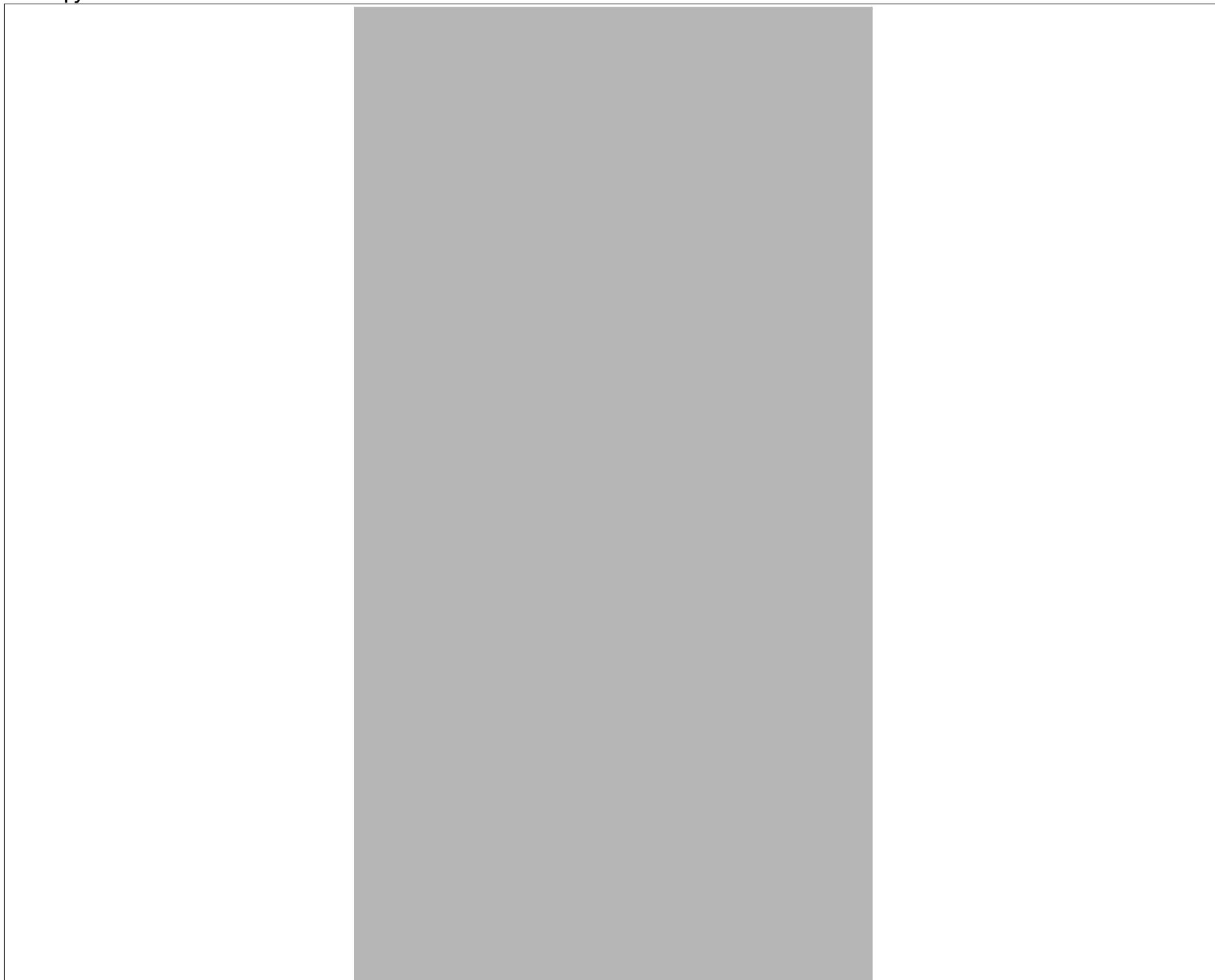

Name	Slide-in screen left	Activate slide-in screen	Disabled	Width	424
Height	800	Active layer	0		

HMI visualization--- Faceplates / PC station [SIMATIC PC station] / HMI_RT_1 [WinCC RT Advanced] / Screen management / Slide-in screens

Slide-in screen right

Hardcopy of Slide-in screen right

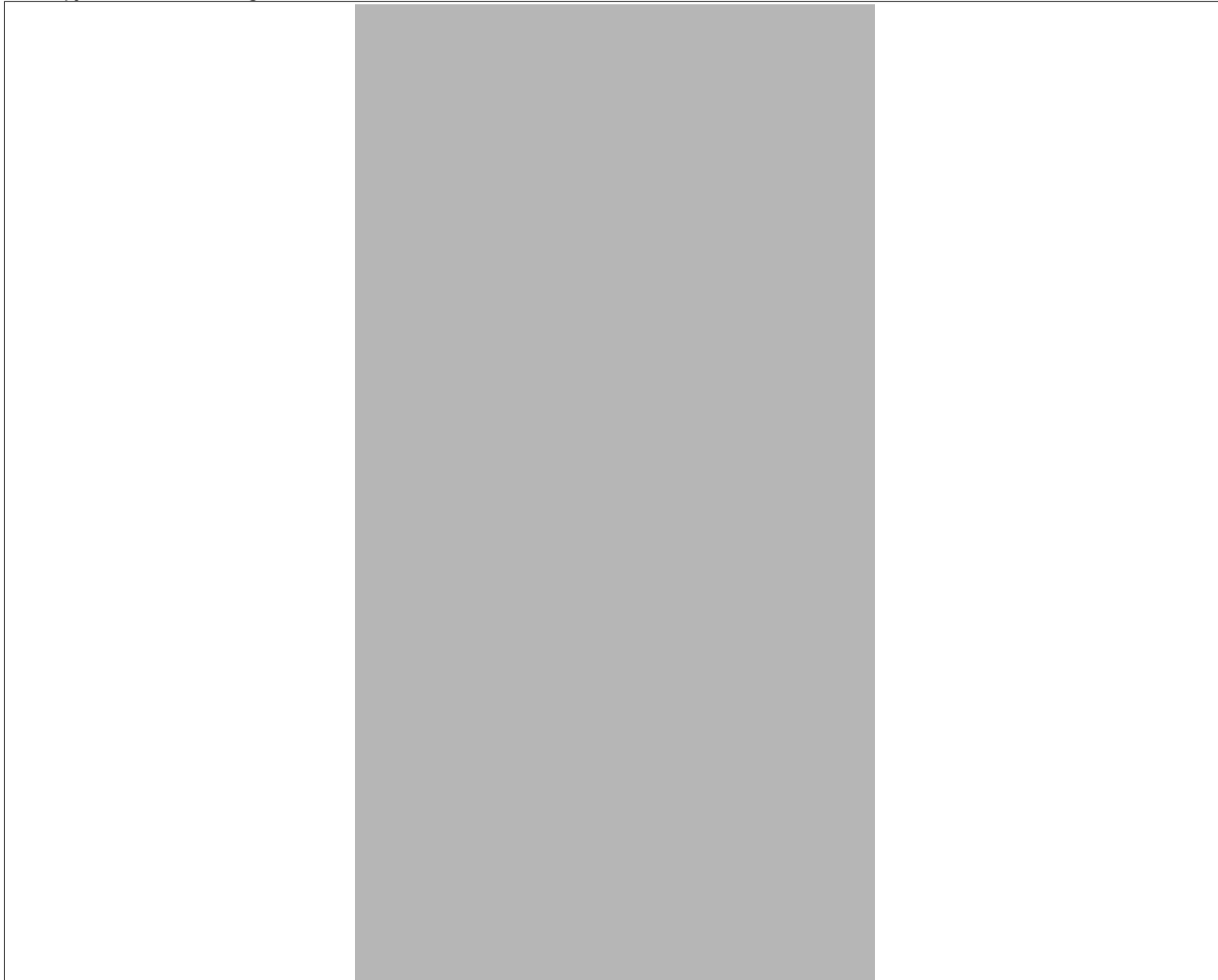

Name	Slide-in screen right	Activate slide-in screen	Disabled	Width	424
Height	800	Active layer	0		

HMI visualization--- Faceplates / PC station [SIMATIC PC station] / HMI_RT_1 [WinCC RT Advanced] / Screen management / Slide-in screens

Slide-in screen top

Hardcopy of Slide-in screen top

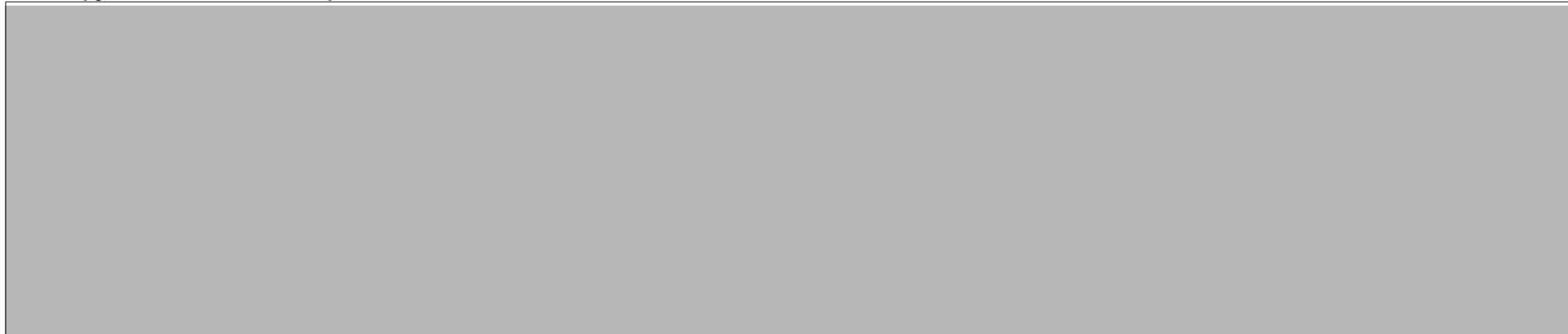

Name	Slide-in screen top	Activate slide-in screen	Disabled	Width	1280
Height	267	Active layer	0		

Instrumentation Tools

Totally Integrated
Automation Portal

HMI visualization--- Faceplates / PC station [SIMATIC PC station] / HMI_RT_1 [WinCC RT Advanced] /
Screen management

Global screen

Hardcopy of Global screen



Name	Global screen	Background color	182, 182, 182	Grid color	0, 0, 0
-------------	---------------	-------------------------	---------------	-------------------	---------

HMI visualization--- Faceplates / PC station [SIMATIC PC station] / HMI_RT_1 [WinCC RT Advanced] / Screen management

Permanent area

Name	Permanent area	Background color	182, 182, 182	Grid color	0, 0, 0
Height	0	Active layer	0		

HMI visualization--- Faceplates / PC station [SIMATIC PC station] / HMI_RT_1 [WinCC RT Advanced] / HMI tags

Default tag table [36]

HMI DATA_FillLevel(in liters)

Name	HMI DATA_FillLevel(in liters)	Display name		Address	
Connection	HMI_Connection_1	Data type	Real	Length	4

HMI DATA_PumpFlow(liters/sec)

Name	HMI DATA_PumpFlow(liters/sec)	Display name		Address	
Connection	HMI_Connection_1	Data type	Real	Length	4

HMI DATA_PLC_Output

Name	HMI DATA_PLC_Output	Display name		Address	
Connection	HMI_Connection_1	Data type	Int	Length	2

HMI DATA_Setpoint(in liters)

Name	HMI DATA_Setpoint(in liters)	Display name		Address	
Connection	HMI_Connection_1	Data type	Real	Length	4

HMI DATA_Tolerance(in liters)

Name	HMI DATA_Tolerance(in liters)	Display name		Address	
Connection	HMI_Connection_1	Data type	Real	Length	4

HMI DATA_RandomNoise

Name	HMI DATA_RandomNoise	Display name		Address	
Connection	HMI_Connection_1	Data type	Int	Length	2

HMI DATA_Disturbance flow (%/sec)

Name	HMI DATA_Disturbance flow (%/sec)	Display name		Address	
Connection	HMI_Connection_1	Data type	Real	Length	4

HMI DATA_IdleTime(ms)

Name	HMI DATA_IdleTime(ms)	Display name		Address	
Connection	HMI_Connection_1	Data type	Int	Length	2

HMI DATA_EmptyTank

Name	HMI DATA_EmptyTank	Display name		Address	
Connection	HMI_Connection_1	Data type	Bool	Length	1

PID_Compact_1_CtrlParamsBackUp_Gain

Name	PID_Compact_1_CtrlParamsBackUp_Gain	Display name		Address	
Connection	HMI_Connection_1	Data type	Real	Length	4

PID_Compact_1_CtrlParamsBackUp_Ti

Name	PID_Compact_1_CtrlParamsBackUp_Ti	Display name		Address	
Connection	HMI_Connection_1	Data type	Real	Length	4

PID_Compact_1_CtrlParamsBackUp_Td

Name	PID_Compact_1_CtrlParamsBackUp_Td	Display name		Address	
Connection	HMI_Connection_1	Data type	Real	Length	4

PID_Compact_1_Retain_CtrlParams_Gain

Name	PID_Compact_1_Retain_CtrlParams_Gain	Display name		Address	
Connection	HMI_Connection_1	Data type	Real	Length	4

PID_Compact_1_Retain_CtrlParams_Ti

Name	PID_Compact_1_Retain_CtrlParams_Ti	Display name		Address	
Connection	HMI_Connection_1	Data type	Real	Length	4

PID_Compact_1_Retain_CtrlParams_Td

Name	PID_Compact_1_Retain_CtrlParams_Td	Display name		Address	
Connection	HMI_Connection_1	Data type	Real	Length	4

PID_Compact_1_Output_PER

Name	PID_Compact_1_Output_PER	Display name		Address	
Connection	HMI_Connection_1	Data type	Int	Length	2

PID_Compact_1_Output

Name	PID_Compact_1_Output	Display name		Address	
Connection	HMI_Connection_1	Data type	Real	Length	4

PID_Compact_1_Error

Name	PID_Compact_1_Error	Display name		Address	
------	---------------------	--------------	--	---------	--

Instrumentation Tools

Totally Integrated Automation Portal					
Connection	HMI_Connection_1	Data type	Bool	Length	1
PID_Compact_1_PIDCtrl					
Name	PID_Compact_1_PIDCtrl	Display name		Address	
Connection	HMI_Connection_1	Length	60		
PID_Compact_1_PIDCtrl_PIDInit					
Name	PID_Compact_1_PIDCtrl_PIDInit	Display name		Address	
Connection	HMI_Connection_1	Data type	Bool	Length	1
PID_Compact_1_Config_SetpointLowerLimit					
Name	PID_Compact_1_Config_SetpointLowerLimit	Display name		Address	
Connection	HMI_Connection_1	Data type	Real	Length	4
Analog Data_TankLevelPLC_input					
Name	Analog Data_TankLevelPLC_input	Display name		Address	
Connection	HMI_Connection_1	Data type	Int	Length	2
HMI DATA_SystemNoise					
Name	HMI DATA_SystemNoise	Display name		Address	
Connection	HMI_Connection_1	Data type	Real	Length	4
PID_Compact_2_Retain_CtrlParams_Gain					
Name	PID_Compact_2_Retain_CtrlParams_Gain	Display name		Address	
Connection	HMI_Connection_1	Data type	Real	Length	4
PID_Compact_2_Retain_CtrlParams_Ti					
Name	PID_Compact_2_Retain_CtrlParams_Ti	Display name		Address	
Connection	HMI_Connection_1	Data type	Real	Length	4
PID_Compact_2_Retain_CtrlParams_Td					
Name	PID_Compact_2_Retain_CtrlParams_Td	Display name		Address	
Connection	HMI_Connection_1	Data type	Real	Length	4
HMI DATA_Disturbance flow (%/sec)_2					
Name	HMI DATA_Disturbance flow (%/sec)_2	Display name		Address	
Connection	HMI_Connection_1	Data type	Real	Length	4
HMI DATA_IdleTime(ms)_2					
Name	HMI DATA_IdleTime(ms)_2	Display name		Address	
Connection	HMI_Connection_1	Data type	Int	Length	2
HMI DATA_PumpFlow(liters/sec)_2					
Name	HMI DATA_PumpFlow(liters/sec)_2	Display name		Address	
Connection	HMI_Connection_1	Data type	Real	Length	4
PID_Compact_2_Output_PWM					
Name	PID_Compact_2_Output_PWM	Display name		Address	
Connection	HMI_Connection_1	Data type	Bool	Length	1
HMI DATA_RandomNoise_2					
Name	HMI DATA_RandomNoise_2	Display name		Address	
Connection	HMI_Connection_1	Data type	Int	Length	2
HMI DATA_PLC_Output_2					
Name	HMI DATA_PLC_Output_2	Display name		Address	
Connection	HMI_Connection_1	Data type	Bool	Length	1
HMI DATA_FillLevel(in liters)_2					
Name	HMI DATA_FillLevel(in liters)_2	Display name		Address	
Connection	HMI_Connection_1	Data type	Real	Length	4
HMI DATA_EmptyTank_2					
Name	HMI DATA_EmptyTank_2	Display name		Address	
Connection	HMI_Connection_1	Data type	Bool	Length	1
HMI DATA_Setpoint(in liters)_2					
Name	HMI DATA_Setpoint(in liters)_2	Display name		Address	
Connection	HMI_Connection_1	Data type	Real	Length	4

Instrumentation Tools

Totally Integrated
Automation Portal

HMI visualization--- Faceplates / PC station [SIMATIC PC station] / HMI_RT_1 [WinCC RT Advanced]

Connections

HMI_Connection_1

Name	Communication driver	Comment
HMI_Connection_1	SIMATIC S7 1500	

HMI visualization--- Faceplates / PC station [SIMATIC PC station] / HMI_RT_1 [WinCC RT Advanced] /
HMI alarms

Discrete alarms

This folder is empty.

Instrumentation Tools

Totally Integrated
Automation Portal

HMI visualization--- Faceplates / PC station [SIMATIC PC station] / HMI_RT_1 [WinCC RT Advanced] /
HMI alarms

Analog alarms

This folder is empty.

HMI visualization--- Faceplates / PC station [SIMATIC PC station] / HMI_RT_1 [WinCC RT Advanced] / HMI alarms

Alarm groups

Alarm_group_1

Name	Alarm_group_1	ID	1
------	---------------	----	---

Alarm_group_10

Name	Alarm_group_10	ID	10
------	----------------	----	----

Alarm_group_11

Name	Alarm_group_11	ID	11
------	----------------	----	----

Alarm_group_12

Name	Alarm_group_12	ID	12
------	----------------	----	----

Alarm_group_13

Name	Alarm_group_13	ID	13
------	----------------	----	----

Alarm_group_14

Name	Alarm_group_14	ID	14
------	----------------	----	----

Alarm_group_15

Name	Alarm_group_15	ID	15
------	----------------	----	----

Alarm_group_16

Name	Alarm_group_16	ID	16
------	----------------	----	----

Alarm_group_2

Name	Alarm_group_2	ID	2
------	---------------	----	---

Alarm_group_3

Name	Alarm_group_3	ID	3
------	---------------	----	---

Alarm_group_4

Name	Alarm_group_4	ID	4
------	---------------	----	---

Alarm_group_5

Name	Alarm_group_5	ID	5
------	---------------	----	---

Alarm_group_6

Name	Alarm_group_6	ID	6
------	---------------	----	---

Alarm_group_7

Name	Alarm_group_7	ID	7
------	---------------	----	---

Alarm_group_8

Name	Alarm_group_8	ID	8
------	---------------	----	---

Alarm_group_9

Name	Alarm_group_9	ID	9
------	---------------	----	---

HMI visualization--- Faceplates / PC station [SIMATIC PC station] / HMI_RT_1 [WinCC RT Advanced] / HMI alarms

Alarm classes

Acknowledgement

Name	Acknowledgement	Display name	A	ID	33
Alarm log	<No log>				

Diagnosis events

Name	Diagnosis events	Display name	S7	ID	4
Alarm log	<No log>				

Errors

Name	Errors	Display name	!	ID	1
Alarm log	<No log>				

No Acknowledgement

Name	No Acknowledgement	Display name	NA	ID	34
Alarm log	<No log>				

System

Name	System	Display name	\$	ID	3
Alarm log	<No log>				

Warnings

Name	Warnings	Display name		ID	2
Alarm log	<No log>				

HMI visualization--- Faceplates / PC station [SIMATIC PC station] / HMI_RT_1 [WinCC RT Advanced] /
HMI alarms

Controller alarms

This folder is empty.

Instrumentation Tools

Totally Integrated
Automation Portal

HMI visualization--- Faceplates / PC station [SIMATIC PC station] / HMI_RT_1 [WinCC RT Advanced] /
HMI alarms

System events

This folder is empty.

HMI visualization--- Faceplates / PC station [SIMATIC PC station] / HMI_RT_1 [WinCC RT Advanced]

Recipes

This folder is empty.

HMI visualization--- Faceplates / PC station [SIMATIC PC station] / HMI_RT_1 [WinCC RT Advanced] /
Historical data

Datalogs

This folder is empty.

HMI visualization--- Faceplates / PC station [SIMATIC PC station] / HMI_RT_1 [WinCC RT Advanced] /
Historical data

AlarmLogs

This folder is empty.

HMI visualization--- Faceplates / PC station [SIMATIC PC station] / HMI_RT_1 [WinCC RT Advanced] / Scripts

VB scripts

This folder is empty.

Instrumentation Tools

Totally Integrated
Automation Portal

HMI visualization--- Faceplates / PC station [SIMATIC PC station] / HMI_RT_1 [WinCC RT Advanced]

Scheduled tasks

This folder is empty.

HMI visualization--- Faceplates / PC station [SIMATIC PC station] / HMI_RT_1 [WinCC RT Advanced]

Cycles

1 h

Name	1 h	Cycle time	1	Cycle unit	hours
------	-----	------------	---	------------	-------

1 min

Name	1 min	Cycle time	1	Cycle unit	minutes
------	-------	------------	---	------------	---------

1 s

Name	1 s	Cycle time	1	Cycle unit	seconds
------	-----	------------	---	------------	---------

10 min

Name	10 min	Cycle time	10	Cycle unit	minutes
------	--------	------------	----	------------	---------

10 s

Name	10 s	Cycle time	10	Cycle unit	seconds
------	------	------------	----	------------	---------

100 ms

Name	100 ms	Cycle time	100	Cycle unit	milliseconds
------	--------	------------	-----	------------	--------------

2 s

Name	2 s	Cycle time	2	Cycle unit	seconds
------	-----	------------	---	------------	---------

5 min

Name	5 min	Cycle time	5	Cycle unit	minutes
------	-------	------------	---	------------	---------

5 s

Name	5 s	Cycle time	5	Cycle unit	seconds
------	-----	------------	---	------------	---------

500 ms

Name	500 ms	Cycle time	500	Cycle unit	milliseconds
------	--------	------------	-----	------------	--------------

HMI visualization--- Faceplates / PC station [SIMATIC PC station] / HMI_RT_1 [WinCC RT Advanced]

Reports

This folder is empty.

HMI visualization--- Faceplates / PC station [SIMATIC PC station] / HMI_RT_1 [WinCC RT Advanced] / Text and graphic lists

Text lists

Controller Type

Name	Controller Type	List range	Value/Range	Comment
Value: 1				
Entry type	Single value	Text	Manual	
Value: 2				
Entry type	Single value	Text	ON/OFF	
Value: 3				
Entry type	Single value	Text	ON/OFF with hysteresis	
Value: Default entry				
Entry type	Single value	Text	OFF	
Value: 0				
Entry type	Single value	Text	OFF	

Random Disturbance

Name	Random Disturbance	List range	Value/Range	Comment
Value: 1				
Entry type	Single value	Text	OFF	
Value: 2				
Entry type	Single value	Text	WEAK	
Value: 3				
Entry type	Single value	Text	MEDIUM	
Value: 4				
Entry type	Single value	Text	STRONG	
Value: Default entry				
Entry type	Single value	Text	OFF	

HMI visualization--- Faceplates / PC station [SIMATIC PC station] / HMI_RT_1 [WinCC RT Advanced] /
Text and graphic lists

Graphic lists

This folder is empty.

Instrumentation Tools

Totally Integrated
Automation Portal

HMI visualization--- Faceplates / PC station [SIMATIC PC station] / HMI_RT_1 [WinCC RT Advanced] /
User administration

User

Administrator

Name	Administrator	Number	1	Automatic logoff	Enabled
Logoff time	5	Groups	Administrator group;		

Instrumentation Tools

Totally Integrated
Automation Portal

HMI visualization--- Faceplates / PC station [SIMATIC PC station] / HMI_RT_1 [WinCC RT Advanced] /
User administration

Groups

Administrator group

Name	Administrator group	Display name	Administrator group	Number	1
Authorizations	User administration; Monitor; Operate;				

Users

Name	Users	Display name	Users	Number	2
Authorizations	Operate;				

Instrumentation Tools

Totally Integrated
Automation Portal

HMI visualization--- Faceplates / PC station [SIMATIC PC station] / HMI_RT_1 [WinCC RT Advanced] /
User administration

Authorizations

Monitor

Name	Monitor	Authorization	Monitor	Authorization number	2
------	---------	---------------	---------	----------------------	---

Operate

Name	Operate	Authorization	Operate	Authorization number	3
------	---------	---------------	---------	----------------------	---

User administration

Name	User administration	Authorization	User administration	Authorization number	1
------	---------------------	---------------	---------------------	----------------------	---

HMI visualization--- Faceplates / PC station [SIMATIC PC station] / Local modules

IE general_1

IE general_1					
Name	IE general_1	Rack	0	Slot	1
Short designation	IE general	Article number	IE_CP	Software version	V8.2.0

HMI visualization--- Faceplates

Ungrouped devices

This folder is empty.

HMI visualization--- Faceplates

Security settings

This folder is empty.

HMI visualization--- Faceplates / Cross-device functions / Project traces

Measurements

This folder is empty.

HMI visualization--- Faceplates / Common data







Alarm classes

Alarm classes			
Name	Display name	Acknowledgment	Priority
Acknowledgement	A	True	0
No Acknowledgement	NA	False	0

HMI visualization--- Faceplates / Common data / Logs

22-08-2023 11:35:01 AM - Update project from the project library

22-08-2023 11:35:01 AM - Update project from the project library

!	Message	Date	Time	User
	▼ Selected types	8/22/2023	11:35:01 AM	
	Tank	8/22/2023	11:35:01 AM	
	▼ Selected devices	8/22/2023	11:35:01 AM	
	PC station	8/22/2023	11:35:01 AM	
	Update options: Update instances in the project: True	8/22/2023	11:35:01 AM	
	Update options: Delete types not in use from the library: False	8/22/2023	11:35:01 AM	
	▼ Update instances in device PC station	8/22/2023	11:35:01 AM	
	▼ Check is made to see if type Tank must be updated.	8/22/2023	11:35:01 AM	
	2 instances pending for update found	8/22/2023	11:35:01 AM	
	Clean up instances in device HMI_RT_1	8/22/2023	11:35:01 AM	

HMI visualization--- Faceplates / Common data

Styles

This folder is empty.

HMI visualization--- Faceplates / Languages & resources

Project languages

Languages

Reference language

English (United States)

Editing language

English (United States)

Other project languages

Empty

HMI visualization--- Faceplates / Languages & resources / Project texts

Project texts

Project texts		
English (United States)	Category	Reference
	Alarm class text	HMI visualization--- Faceplates\PC station [SIMATIC PC station]\HMI_RT_1 [WinCC RT Advanced]\HMI alarms\Errors\alarmclass name not set\ShortName
	Alarm class text	HMI visualization--- Faceplates\PC station [SIMATIC PC station]\HMI_RT_1 [WinCC RT Advanced]\HMI alarms\Warnings\alarmclass name not set_1\ShortName
	Alarm class text	HMI visualization--- Faceplates\PC station [SIMATIC PC station]\HMI_RT_1 [WinCC RT Advanced]\HMI alarms\System\alarmclass name not set_2\ShortName
	Alarm class text	HMI visualization--- Faceplates\PC station [SIMATIC PC station]\HMI_RT_1 [WinCC RT Advanced]\HMI alarms\Diagnosis events\alarmclass name not set_3\ShortName
	Alarm class text	HMI visualization--- Faceplates\PC station [SIMATIC PC station]\HMI_RT_1 [WinCC RT Advanced]\HMI alarms\Safety warnings\alarmclass name not set_4\ShortName
	Alarm class text	HMI visualization--- Faceplates\PC station [SIMATIC PC station]\HMI_RT_1 [WinCC RT Advanced]\HMI alarms\Acknowledgement\ShortName
	Alarm class text	HMI visualization--- Faceplates\PC station [SIMATIC PC station]\HMI_RT_1 [WinCC RT Advanced]\HMI alarms\No Acknowledgement\ShortName
	Alarm text	HMI visualization--- Faceplates\PC station [SIMATIC PC station]\HMI_RT_1 [WinCC RT Advanced]\HMI alarms\Warnings\alarmclass name not set_1\AlarmClassData_IDisplayNaming_DisplayName
	Alarm text	HMI visualization--- Faceplates\PC station [SIMATIC PC station]\HMI_RT_1 [WinCC RT Advanced]\HMI alarms\Acknowledgement\AlarmClassData_IDisplayNaming_DisplayName
	Alarm text	HMI visualization--- Faceplates\PC station [SIMATIC PC station]\HMI_RT_1 [WinCC RT Advanced]\HMI alarms\No Acknowledgement\AlarmClassData_IDisplayNaming_DisplayName
!	Alarm text	HMI visualization--- Faceplates\PC station [SIMATIC PC station]\HMI_RT_1 [WinCC RT Advanced]\HMI alarms\Errors\alarmclass name not set\AlarmClassData_IDisplayNaming_DisplayName
!!	Alarm text	HMI visualization--- Faceplates\PC station [SIMATIC PC station]\HMI_RT_1 [WinCC RT Advanced]\HMI alarms\Safety warnings\alarmclass name not set_4\AlarmClassData_IDisplayNaming_DisplayName
"Main Program Sweep (Cycle)"	Block comment	HMI visualization--- Faceplates\PLC_1 [CPU 1512C-1 PN]\Program blocks\Main [OB1]\Block title
\$	Alarm text	HMI visualization--- Faceplates\PC station [SIMATIC PC station]\HMI_RT_1 [WinCC RT Advanced]\HMI alarms\System\alarmclass name not set_2\AlarmClassData_IDisplayNaming_DisplayName
PID_Output	HMI screen	HMI visualization--- Faceplates\PC station [SIMATIC PC station]\HMI_RT_1 [WinCC RT Advanced]\Screens\Control\Text field_6\Text
PID_PWM	HMI screen	HMI visualization--- Faceplates\PC station [SIMATIC PC station]\HMI_RT_1 [WinCC RT Advanced]\Screens\Control\Text field_9\Text
0	HMI screen	HMI visualization--- Faceplates\PC station [SIMATIC PC station]\HMI_RT_1 [WinCC RT Advanced]\Screens\Control\Symbolic I/O field_2\Text OFF
0	HMI screen	HMI visualization--- Faceplates\PC station [SIMATIC PC station]\HMI_RT_1 [WinCC RT Advanced]\Screens\Control\Symbolic I/O field_1\Text OFF
1	HMI screen	HMI visualization--- Faceplates\PC station [SIMATIC PC station]\HMI_RT_1 [WinCC RT Advanced]\Screens\Control\Symbolic I/O field_2\Text ON
1	HMI screen	HMI visualization--- Faceplates\PC station [SIMATIC PC station]\HMI_RT_1 [WinCC RT Advanced]\Screens\Control\Symbolic I/O field_1\Text ON
A	Alarm class text	HMI visualization--- Faceplates\Acknowledgement\AlarmClassData_IDisplayNaming_DisplayName
A	Alarm class text	HMI visualization--- Faceplates\Acknowledgement\ShortName
A	Alarm text	HMI visualization--- Faceplates\PC station [SIMATIC PC station]\HMI_RT_1 [WinCC RT Advanced]\HMI alarms\Errors\AcknowledgedText
A	Alarm text	HMI visualization--- Faceplates\PC station [SIMATIC PC station]\HMI_RT_1 [WinCC RT Advanced]\HMI alarms\Warnings\AcknowledgedText
A	Alarm text	HMI visualization--- Faceplates\PC station [SIMATIC PC station]\HMI_RT_1 [WinCC RT Advanced]\HMI alarms\System\AcknowledgedText
A	Alarm text	HMI visualization--- Faceplates\PC station [SIMATIC PC station]\HMI_RT_1 [WinCC RT Advanced]\HMI alarms\Diagnosis events\AcknowledgedText
A	Alarm text	HMI visualization--- Faceplates\PC station [SIMATIC PC station]\HMI_RT_1 [WinCC RT Advanced]\HMI alarms\Safety warnings\AcknowledgedText
A	Alarm text	HMI visualization--- Faceplates\PC station [SIMATIC PC station]\HMI_RT_1 [WinCC RT Advanced]\HMI alarms\Acknowledgement\AcknowledgedText
A	Alarm text	HMI visualization--- Faceplates\PC station [SIMATIC PC station]\HMI_RT_1 [WinCC RT Advanced]\HMI alarms\No Acknowledgement\AcknowledgedText
A level sensor will convert a 0-50liters level measurements into a 0-10 V signal. which then goes into the PLC Input module	Block comment	HMI visualization--- Faceplates\PLC_1 [CPU 1512C-1 PN]\Program blocks\AnalogInputs [FC1]\Network 1\Comment
Activates remote authorization for the use of client-server scenarios.	HMI comment	HMI visualization--- Faceplates\PC station [SIMATIC PC station]\HMI_RT_1 [WinCC RT Advanced]\User administration\Enable remote control\Comment
Administrator group	HMI runtime	HMI visualization--- Faceplates\PC station [SIMATIC PC station]\HMI_RT_1 [WinCC RT Advanced]\User administration\Administrator group\DisplayName
Authorization 'User administration' for managing users in the user view in Runtime.	HMI comment	HMI visualization--- Faceplates\PC station [SIMATIC PC station]\HMI_RT_1 [WinCC RT Advanced]\User administration\User administration\Comment
Compact PID_Controller with self-tuning	Block comment	HMI visualization--- Faceplates\PLC_1 [CPU 1512C-1 PN]\Program blocks\System blocks\Program resources\PID_Compact [FB1130]\Block title
configuration data set	Block comment	HMI visualization--- Faceplates\PLC_1 [CPU 1512C-1 PN]\PLC data types\System data types \PID_CompactConfig\Title of the PLC data type
controlling parameter set	Block comment	HMI visualization--- Faceplates\PLC_1 [CPU 1512C-1 PN]\PLC data types\System data types \PID_CompactControlParams\Title of the PLC data type
data for controlling part	Block comment	HMI visualization--- Faceplates\PLC_1 [CPU 1512C-1 PN]\PLC data types\System data types \PID_CompactControl\Title of the PLC data type
data for estimation of deviance	Block comment	HMI visualization--- Faceplates\PLC_1 [CPU 1512C-1 PN]\PLC data types\System data types \PID_StandardDeviation\Title of the PLC data type
data for scaling	Block comment	HMI visualization--- Faceplates\PLC_1 [CPU 1512C-1 PN]\PLC data types\System data types \PID_Scaling\Title of the PLC data type
data set for cycle time estimation	Block comment	HMI visualization--- Faceplates\PLC_1 [CPU 1512C-1 PN]\PLC data types\System data types \PID_CycleTime\Title of the PLC data type

Instrumentation Tools

Totally Integrated Automation Portal			
English (United States)	Category	Reference	
data set for self tuning	Block comment	HMI visualization--- Faceplates\PLC_1 [CPU 1512C-1 PN]\PLC data types\System data types \PID_CompactSelfTune\Title of the PLC data type	
data set for start up tuning	Block comment	HMI visualization--- Faceplates\PLC_1 [CPU 1512C-1 PN]\PLC data types\System data types \PID_Compact_SUT\Title of the PLC data type	
data set for tuning in run	Block comment	HMI visualization--- Faceplates\PLC_1 [CPU 1512C-1 PN]\PLC data types\System data types \PID_Compact_TIR\Title of the PLC data type	
dataset of parameters for gradient estimation	Block comment	HMI visualization--- Faceplates\PLC_1 [CPU 1512C-1 PN]\PLC data types\System data types \PID_GradientParams\Title of the PLC data type	
Deravative gain	HMI screen	HMI visualization--- Faceplates\PC station [SIMATIC PC station]\HMI_RT_1 [WinCC RT Ad-advanced]\Screens\Control\Text field_8\Text	
Deravative gain	HMI screen	HMI visualization--- Faceplates\PC station [SIMATIC PC station]\HMI_RT_1 [WinCC RT Ad-advanced]\Screens\Control\Text field_18\Text	
Disturbance	HMI screen	HMI visualization--- Faceplates\PC station [SIMATIC PC station]\HMI_RT_1 [WinCC RT Ad-advanced]\Screens\Control\Text field_4\Text	
Disturbance	HMI screen	HMI visualization--- Faceplates\PC station [SIMATIC PC station]\HMI_RT_1 [WinCC RT Ad-advanced]\Screens\Control\Text field_14\Text	
Disturbance- outflow	Block comment	HMI visualization--- Faceplates\PLC_1 [CPU 1512C-1 PN]\Program blocks\tank Simulator [FB2]\Network 9\Title	
Disturbance- random	Block comment	HMI visualization--- Faceplates\PLC_1 [CPU 1512C-1 PN]\Program blocks\tank Simulator [FB2]\Network 8\Title	
Empty Tank	HMI screen	HMI visualization--- Faceplates\PC station [SIMATIC PC station]\HMI_RT_1 [WinCC RT Ad-advanced]\Screens\Control\Button_1\Text OFF	
Empty Tank	HMI screen	HMI visualization--- Faceplates\PC station [SIMATIC PC station]\HMI_RT_1 [WinCC RT Ad-advanced]\Screens\Control\Button_2\Text OFF	
empty tank and PID integral sum	Block comment	HMI visualization--- Faceplates\PLC_1 [CPU 1512C-1 PN]\Program blocks\Main [OB1]\Network 5\Title	
fill level clamping	Block comment	HMI visualization--- Faceplates\PLC_1 [CPU 1512C-1 PN]\Program blocks\tank Simulator [FB2]\Network 10\Title	
I	Alarm text	HMI visualization--- Faceplates\PC station [SIMATIC PC station]\HMI_RT_1 [WinCC RT Ad-advanced]\HMI alarms\Errors\ComingText	
I	Alarm text	HMI visualization--- Faceplates\PC station [SIMATIC PC station]\HMI_RT_1 [WinCC RT Ad-advanced]\HMI alarms\Warnings\ComingText	
I	Alarm text	HMI visualization--- Faceplates\PC station [SIMATIC PC station]\HMI_RT_1 [WinCC RT Ad-advanced]\HMI alarms\System\ComingText	
I	Alarm text	HMI visualization--- Faceplates\PC station [SIMATIC PC station]\HMI_RT_1 [WinCC RT Ad-advanced]\HMI alarms\Diagnosis events\ComingText	
I	Alarm text	HMI visualization--- Faceplates\PC station [SIMATIC PC station]\HMI_RT_1 [WinCC RT Ad-advanced]\HMI alarms\Safety warnings\ComingText	
I	Alarm text	HMI visualization--- Faceplates\PC station [SIMATIC PC station]\HMI_RT_1 [WinCC RT Ad-advanced]\HMI alarms\Acknowledgement\ComingText	
I	Alarm text	HMI visualization--- Faceplates\PC station [SIMATIC PC station]\HMI_RT_1 [WinCC RT Ad-advanced]\HMI alarms\No Acknowledgement\ComingText	
Idle Time	HMI screen	HMI visualization--- Faceplates\PC station [SIMATIC PC station]\HMI_RT_1 [WinCC RT Ad-advanced]\Screens\Control\Text field_5\Text	
Idle Time	HMI screen	HMI visualization--- Faceplates\PC station [SIMATIC PC station]\HMI_RT_1 [WinCC RT Ad-advanced]\Screens\Control\Text field_15\Text	
Idle time clamping	Block comment	HMI visualization--- Faceplates\PLC_1 [CPU 1512C-1 PN]\Program blocks\tank Simulator [FB2]\Network 2\Title	
Integral gain	HMI screen	HMI visualization--- Faceplates\PC station [SIMATIC PC station]\HMI_RT_1 [WinCC RT Ad-advanced]\Screens\Control\Text field_7\Text	
Integral gain	HMI screen	HMI visualization--- Faceplates\PC station [SIMATIC PC station]\HMI_RT_1 [WinCC RT Ad-advanced]\Screens\Control\Text field_17\Text	
IO	Alarm text	HMI visualization--- Faceplates\PC station [SIMATIC PC station]\HMI_RT_1 [WinCC RT Ad-advanced]\HMI alarms\Errors\ComingGoingText	
IO	Alarm text	HMI visualization--- Faceplates\PC station [SIMATIC PC station]\HMI_RT_1 [WinCC RT Ad-advanced]\HMI alarms\Warnings\ComingGoingText	
IO	Alarm text	HMI visualization--- Faceplates\PC station [SIMATIC PC station]\HMI_RT_1 [WinCC RT Ad-advanced]\HMI alarms\System\ComingGoingText	
IO	Alarm text	HMI visualization--- Faceplates\PC station [SIMATIC PC station]\HMI_RT_1 [WinCC RT Ad-advanced]\HMI alarms\Diagnosis events\ComingGoingText	
IO	Alarm text	HMI visualization--- Faceplates\PC station [SIMATIC PC station]\HMI_RT_1 [WinCC RT Ad-advanced]\HMI alarms\Safety warnings\ComingGoingText	
IO	Alarm text	HMI visualization--- Faceplates\PC station [SIMATIC PC station]\HMI_RT_1 [WinCC RT Ad-advanced]\HMI alarms\Acknowledgement\ComingGoingText	
IO	Alarm text	HMI visualization--- Faceplates\PC station [SIMATIC PC station]\HMI_RT_1 [WinCC RT Ad-advanced]\HMI alarms\No Acknowledgement\ComingGoingText	
Manual	HMI runtime	HMI visualization--- Faceplates\PC station [SIMATIC PC station]\HMI_RT_1 [WinCC RT Ad-advanced]\Text and graphic lists\Controller Type\Text_list_entry_1\Text	
MEDIUM	HMI runtime	HMI visualization--- Faceplates\PC station [SIMATIC PC station]\HMI_RT_1 [WinCC RT Ad-advanced]\Text and graphic lists\Random Disturbance\Text_list_entry_4\Text	
Monitor	HMI runtime	HMI visualization--- Faceplates\PC station [SIMATIC PC station]\HMI_RT_1 [WinCC RT Ad-advanced]\User administration\Monitor\ShortName	
'Monitor' authorization.	HMI comment	HMI visualization--- Faceplates\PC station [SIMATIC PC station]\HMI_RT_1 [WinCC RT Ad-advanced]\User administration\Monitor\Comment	
NA	Alarm class text	HMI visualization--- Faceplates\No Acknowledgement\AlarmClassData_IDisplayNaming_Dis-playName	
NA	Alarm class text	HMI visualization--- Faceplates\No Acknowledgement\ShortName	
O	Alarm text	HMI visualization--- Faceplates\PC station [SIMATIC PC station]\HMI_RT_1 [WinCC RT Ad-advanced]\HMI alarms\Errors\GoingText	
O	Alarm text	HMI visualization--- Faceplates\PC station [SIMATIC PC station]\HMI_RT_1 [WinCC RT Ad-advanced]\HMI alarms\Warnings\GoingText	
O	Alarm text	HMI visualization--- Faceplates\PC station [SIMATIC PC station]\HMI_RT_1 [WinCC RT Ad-advanced]\HMI alarms\System\GoingText	
O	Alarm text	HMI visualization--- Faceplates\PC station [SIMATIC PC station]\HMI_RT_1 [WinCC RT Ad-advanced]\HMI alarms\Diagnosis events\GoingText	
O	Alarm text	HMI visualization--- Faceplates\PC station [SIMATIC PC station]\HMI_RT_1 [WinCC RT Ad-advanced]\HMI alarms\Safety warnings\GoingText	
O	Alarm text	HMI visualization--- Faceplates\PC station [SIMATIC PC station]\HMI_RT_1 [WinCC RT Ad-advanced]\HMI alarms\Acknowledgement\GoingText	
O	Alarm text	HMI visualization--- Faceplates\PC station [SIMATIC PC station]\HMI_RT_1 [WinCC RT Ad-advanced]\HMI alarms\No Acknowledgement\GoingText	

Instrumentation Tools

Totally Integrated Automation Portal			
English (United States)	Category	Reference	
OFF	HMI runtime	HMI visualization--- Faceplates\PC station [SIMATIC PC station]\HMI_RT_1 [WinCC RT Advanced]\Text and graphic lists\Controller Type\Text_list_entry_4\Text	
OFF	HMI runtime	HMI visualization--- Faceplates\PC station [SIMATIC PC station]\HMI_RT_1 [WinCC RT Advanced]\Text and graphic lists\Random Disturbance\Text_list_entry_5\Text	
OFF	HMI runtime	HMI visualization--- Faceplates\PC station [SIMATIC PC station]\HMI_RT_1 [WinCC RT Advanced]\Text and graphic lists\Random Disturbance\Text_list_entry_2\Text	
OFF	HMI runtime	HMI visualization--- Faceplates\PC station [SIMATIC PC station]\HMI_RT_1 [WinCC RT Advanced]\Text and graphic lists\Controller Type\Text_list_entry_5\Text	
ON/OFF	HMI runtime	HMI visualization--- Faceplates\PC station [SIMATIC PC station]\HMI_RT_1 [WinCC RT Advanced]\Text and graphic lists\Controller Type\Text_list_entry_2\Text	
ON/OFF with hysteresis	HMI runtime	HMI visualization--- Faceplates\PC station [SIMATIC PC station]\HMI_RT_1 [WinCC RT Advanced]\Text and graphic lists\Controller Type\Text_list_entry_3\Text	
Operate	HMI runtime	HMI visualization--- Faceplates\PC station [SIMATIC PC station]\HMI_RT_1 [WinCC RT Advanced]\User administration\Operate\ShortName	
'Operate' authorization.	HMI comment	HMI visualization--- Faceplates\PC station [SIMATIC PC station]\HMI_RT_1 [WinCC RT Advanced]\User administration\Operate\Comment	
OutFlow	HMI screen	HMI visualization--- Faceplates\PC station [SIMATIC PC station]\HMI_RT_1 [WinCC RT Advanced]\Screens\Control\Text field_3\Text	
OutFlow	HMI screen	HMI visualization--- Faceplates\PC station [SIMATIC PC station]\HMI_RT_1 [WinCC RT Advanced]\Screens\Control\Text field_13\Text	
OUTPTUT	HMI screen	HMI visualization--- Faceplates\PC station [SIMATIC PC station]\HMI_RT_1 [WinCC RT Advanced]\Screens\Control\Text field_10\Text	
OUTPTUT	HMI screen	HMI visualization--- Faceplates\PC station [SIMATIC PC station]\HMI_RT_1 [WinCC RT Advanced]\Screens\Control\Text field_19\Text	
PID controller for TANK2	Block comment	HMI visualization--- Faceplates\PLC_1 [CPU 1512C-1 PN]\Program blocks\Cyclic interrupt_Tank-Level_PID_PWM [OB33]\Network 1\Title	
PLC output module will take the output value 0-32767 and convert it to analog range of 0-10V	Block comment	HMI visualization--- Faceplates\PLC_1 [CPU 1512C-1 PN]\Program blocks\AnalogOutputs [FC2]\Network 1\Comment	
Proportial gain	HMI screen	HMI visualization--- Faceplates\PC station [SIMATIC PC station]\HMI_RT_1 [WinCC RT Advanced]\Screens\Control\Text field_2\Text	
Proportial gain	HMI screen	HMI visualization--- Faceplates\PC station [SIMATIC PC station]\HMI_RT_1 [WinCC RT Advanced]\Screens\Control\Text field_16\Text	
Pump flow	HMI screen	HMI visualization--- Faceplates\PC station [SIMATIC PC station]\HMI_RT_1 [WinCC RT Advanced]\Screens\Control\Text field_11\Text	
Pump flow	HMI screen	HMI visualization--- Faceplates\PC station [SIMATIC PC station]\HMI_RT_1 [WinCC RT Advanced]\Screens\Control\Text field_20\Text	
pump output memory	Block comment	HMI visualization--- Faceplates\PLC_1 [CPU 1512C-1 PN]\Program blocks\Tank Simulator [FB2]\Network 3\Title	
QGR	Alarm text	HMI visualization--- Faceplates\PC station [SIMATIC PC station]\HMI_RT_1 [WinCC RT Advanced]\Runtime settings\HmiAlarmSettingsData\AcknowledgementGroupText	
random disturbance strength	Block comment	HMI visualization--- Faceplates\PLC_1 [CPU 1512C-1 PN]\Program blocks\Tank Simulator [FB2]\Network 7\Title	
Random value for disturbance - 1st step	Block comment	HMI visualization--- Faceplates\PLC_1 [CPU 1512C-1 PN]\Program blocks\Tank Simulator [FB2]\Network 5\Title	
random value of disturbance- 2nd step	Block comment	HMI visualization--- Faceplates\PLC_1 [CPU 1512C-1 PN]\Program blocks\Tank Simulator [FB2]\Network 6\Title	
retain data	Block comment	HMI visualization--- Faceplates\PLC_1 [CPU 1512C-1 PN]\PLC data types\System data types \PID_CompactRetain\Title of the PLC data type	
S7	Alarm text	HMI visualization--- Faceplates\PC station [SIMATIC PC station]\HMI_RT_1 [WinCC RT Advanced]\HMI alarms\Diagnosis events\alarmclass name not set_3\AlarmClassData_IDisplay-Naming_DisplayName	
Set Point	HMI screen	HMI visualization--- Faceplates\PC station [SIMATIC PC station]\HMI_RT_1 [WinCC RT Advanced]\Screens\Control\Text field_1\Text	
Set Point	HMI screen	HMI visualization--- Faceplates\PC station [SIMATIC PC station]\HMI_RT_1 [WinCC RT Advanced]\Screens\Control\Text field_12\Text	
setpoint clamping	Block comment	HMI visualization--- Faceplates\PLC_1 [CPU 1512C-1 PN]\Program blocks\Tank Simulator [FB2]\Network 1\Title	
simulation of TANK1 analog input of the level sensor to the PLC	Block comment	HMI visualization--- Faceplates\PLC_1 [CPU 1512C-1 PN]\Program blocks\Main [OB1]\Network 1\Title	
simulation of TANK2 analog input of the level sensor to the PLC	Block comment	HMI visualization--- Faceplates\PLC_1 [CPU 1512C-1 PN]\Program blocks\Main [OB1]\Network 2\Title	
Simulation of the behaviour of the pump of 0-10 liters/sec in corresponding to 0-10v PLC output	Block comment	HMI visualization--- Faceplates\PLC_1 [CPU 1512C-1 PN]\Program blocks\Main [OB1]\Network 3\Title	
SIMULATION OF THE TANK2 pump output corresponding to the ON/OFF behavior of the PID_PWM	Block comment	HMI visualization--- Faceplates\PLC_1 [CPU 1512C-1 PN]\Program blocks\Main [OB1]\Network 4\Title	
STRONG	HMI runtime	HMI visualization--- Faceplates\PC station [SIMATIC PC station]\HMI_RT_1 [WinCC RT Advanced]\Text and graphic lists\Random Disturbance\Text_list_entry_1\Text	
structure for gradient estimation	Block comment	HMI visualization--- Faceplates\PLC_1 [CPU 1512C-1 PN]\PLC data types\System data types \PID_GradientEstimation\Title of the PLC data type	
tank 1 simulator	Block comment	HMI visualization--- Faceplates\PLC_1 [CPU 1512C-1 PN]\Program blocks\Cyclic_interrupt_1ms_TANK1Simulation [OB32]\Network 1\Title	
Tank level progress	Block comment	HMI visualization--- Faceplates\PLC_1 [CPU 1512C-1 PN]\Program blocks\Tank Simulator [FB2]\Network 4\Title	
Text	HMI screen	HMI visualization--- Faceplates\PC station [SIMATIC PC station]\HMI_RT_1 [WinCC RT Advanced]\Screens\Control\Button_1\Text ON	
Text	HMI screen	HMI visualization--- Faceplates\PC station [SIMATIC PC station]\HMI_RT_1 [WinCC RT Advanced]\Screens\Control\Button_2\Text ON	
the 0-10V readings at the input module will be converted to the 0-50 liters measurements of the sensor	Block comment	HMI visualization--- Faceplates\PLC_1 [CPU 1512C-1 PN]\Program blocks\AnalogInputs [FC1]\Network 2\Comment	
The 'Administrator' group is initially granted all rights.	HMI comment	HMI visualization--- Faceplates\PC station [SIMATIC PC station]\HMI_RT_1 [WinCC RT Advanced]\User administration\Administrator group\Comment	
The user 'Administrator' is assigned to the 'Administrator' group.	HMI comment	HMI visualization--- Faceplates\PC station [SIMATIC PC station]\HMI_RT_1 [WinCC RT Advanced]\User administration\Administrator\Comment	
The 'Users' group is initially granted 'Operating' rights.	HMI comment	HMI visualization--- Faceplates\PC station [SIMATIC PC station]\HMI_RT_1 [WinCC RT Advanced]\User administration\Users\Comment	

Instrumentation Tools

English (United States)	Category	Reference
this block will simulate the existance of a real level sensor. we don't acutally have a real level sensor, so we will simulate this sensor as fo-low	Block comment	HMI visualization--- Faceplates\PLC_1 [CPU 1512C-1 PN]\Program blocks\AnalogInputs [FC1]\Block comment
This code is collecting and processing pump flow rates and tank status. It calculates the average pump flow rate over a 1ms(which is the calling interval of the cyclic interrupt) interval and resets the data if the tank is empty is activ.	Block comment	HMI visualization--- Faceplates\PLC_1 [CPU 1512C-1 PN]\Program blocks\tank Simulator [FB2]\Network 3\Comment
User administration	HMI runtime	HMI visualization--- Faceplates\PC station [SIMATIC PC station]\HMI_RT_1 [WinCC RT Advanced]\User administration\User administration\ShortName
Users	HMI runtime	HMI visualization--- Faceplates\PC station [SIMATIC PC station]\HMI_RT_1 [WinCC RT Advanced]\User administration\Users\DisplayName
WEAK	HMI runtime	HMI visualization--- Faceplates\PC station [SIMATIC PC station]\HMI_RT_1 [WinCC RT Advanced]\Text and graphic lists\Random Disturbance\Text_list_entry_3\Text
Web access - view only. Authorization for the use of WebNavigator and for client-server systems.	HMI comment	HMI visualization--- Faceplates\PC station [SIMATIC PC station]\HMI_RT_1 [WinCC RT Advanced]\User administration\Web access - view only\Comment



HMI visualization--- Faceplates / Languages & resources

Project graphics

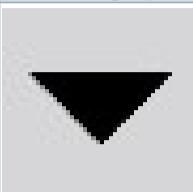
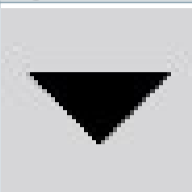
Down_Arrow

Standard graphic	English (United States)
	
▶ <i>Dithering mode</i>	
Same color	Same color
▶ <i>Smoothing</i>	
Disabled	Disabled

Home

Standard graphic	English (United States)
	
▶ <i>Dithering mode</i>	
Same color	Same color
▶ <i>Smoothing</i>	
Disabled	Disabled

Left_Arrow

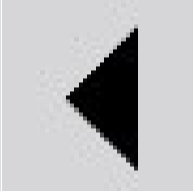
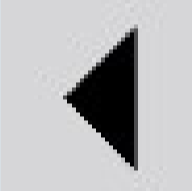
Standard graphic	English (United States)
	
▶ <i>Dithering mode</i>	
Same color	Same color
▶ <i>Smoothing</i>	
Disabled	Disabled

Right_Arrow

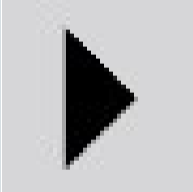
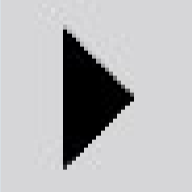
Standard graphic	English (United States)
	
▶ <i>Dithering mode</i>	
Same color	Same color
▶ <i>Smoothing</i>	
Disabled	Disabled

Up_Arrow

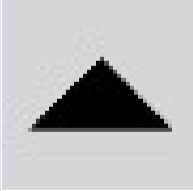
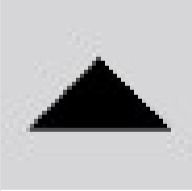
Standard graphic	English (United States)
	
▶ <i>Dithering mode</i>	
Same color	Same color
▶ <i>Smoothing</i>	
Disabled	Disabled