

PLC

CC-Link IE TSN

This fundamentals course explains the features of CC-Link IE TSN and how to start up the system.

This fundamentals course is aimed at first-time users of the CC-Link IE TSN.

In this course you will learn about features and the installation advantages of CC-Link IE TSN, and how to start up the system.

- FA Equipment for Beginners (Industrial Network)
- MELSEC iQ-R Series Basic
- Programming Basics

The contents of this course are as follows.

Chapter 1 FA networks

Preliminary information on FA networks

Chapter 2 Introduction of CC-Link IE TSN

Mechanism and the installation advantages of CC-Link IE TSN

Chapter 3 System design

Required knowledge for system start-up

Chapter 4 System start-up of the master station and remote stations

Procedures from system start-up to operation check





Chapter 5 System start-up of the master station and local stations

Procedures from system start-up to operation check

Final Test

Passing grade: 60% or higher.

Introduction How to Use This e-Learning Tool

Go to the next page		Go to the next page.
Back to the previous page		Back to the previous page.
Move to the desired page		"Table of Contents" will be displayed, enabling you to navigate to the desired page.
Exit the learning		Exit the learning.

Safety precautions

When you learn based on using actual products, please carefully read the safety precautions in the corresponding manuals.

With the spread of the Internet and the introduction of LAN and Wi-Fi in our homes, the term "network" has become common. LANs are installed at the factory and information such as a daily production plan and shipment status is transmitted through the LANs.

This chapter describes FA networks different from general LANs.

1.1 Necessity of FA networks

1.2 FA network applications

1.3 Data communication methods of FA networks

1.4 Cyclic transmission operation

1.5 Data update for cyclic transmission (remote I/O)

This section describes the reasons why we use FA networks.

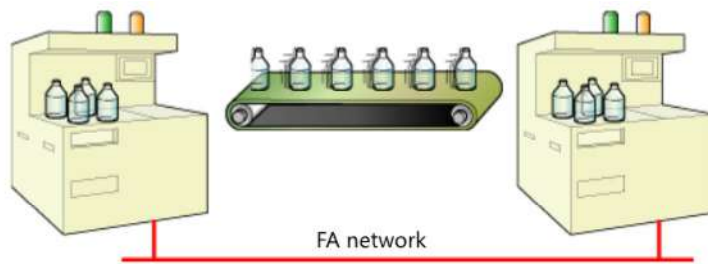

FA networks facilitates the information exchange when the machines must be installed separately.

Information between devices should be updated as if the information is referred to the same device area.

Primarily information networks for LANs are accepted even if they may not acquire data depending on the network status when the data is required. The features of FA networks required differ from general LANs.

FA networks are primarily used in the following two applications. Select the optimal configuration in accordance with the desired features.

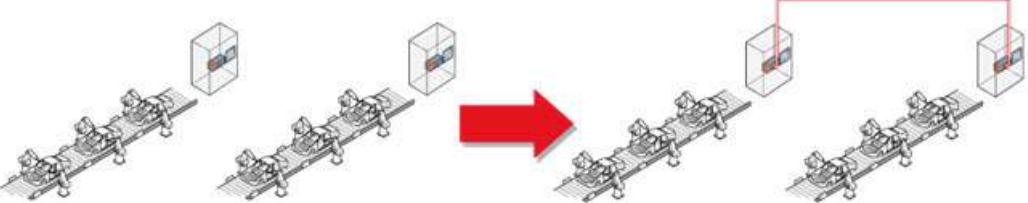
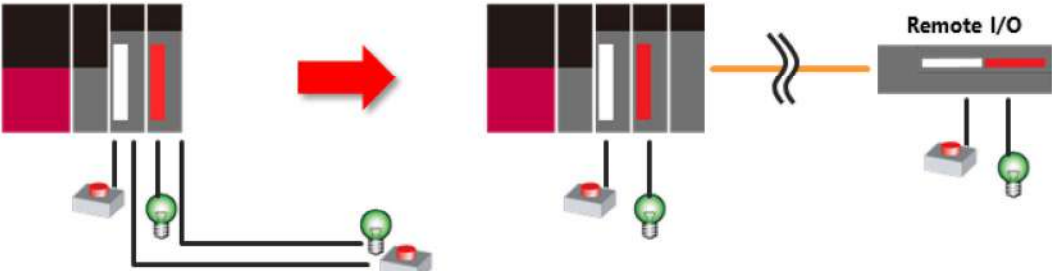
Network application	Description
Information exchange (Distributed control for controllers)	<p>This configuration is used to exchange information between programmable controllers. Connecting distributed equipment (controllers) via a network improves flexibility, scalability, and ease of maintenance for automation systems.</p> 
Remote I/O (Distributed I/O control)	<p>Simply extending I/O cables throughout a system can be susceptible to noise, which can cause operational errors. In addition, bundling many thick I/O cables can be cumbersome. Transferring I/O status to the programmable controllers via a network remotely results in avoiding noise influence or bulky wiring. This is remote I/O. Remote I/O system has sequence programs in one CPU module, which helps with troubleshooting when errors occur. This system is relatively inexpensive to build.</p> 

CC-Link IE TSN can be used in both of these applications.

The following two data communication methods are used in FA networks.

- Cyclic transmission
- Transient transmission

The following table summarizes each method.

Transmission system	Data communication overview	Send/receive program
Cyclic transmission	Updates the specified data range cyclically and automatically and behaves as if information in the same device is referred to between network devices.	Not required (Data is sent/received according to the settings)
Transient transmission	Data is exchanged only when a communication request is issued between devices in a network. This transmission is performed between cyclic transmissions.	Required (Data is sent/received by a program as necessary)

The simultaneous use of cyclic transmission and transient transmission is supported in CC-Link IE TSN.

This course focuses specifically on **cyclic transmission**, which is the primary type of communication performed in FA networks.

For distributed I/O, the following video shows how device data is changed by using the network.

When a switch turns on at the remote station (input), this state change is transferred to the master station over the network. When the master station output turns on, this state change is transferred to a remote station (output) over the network.

Click the play button to start the video.

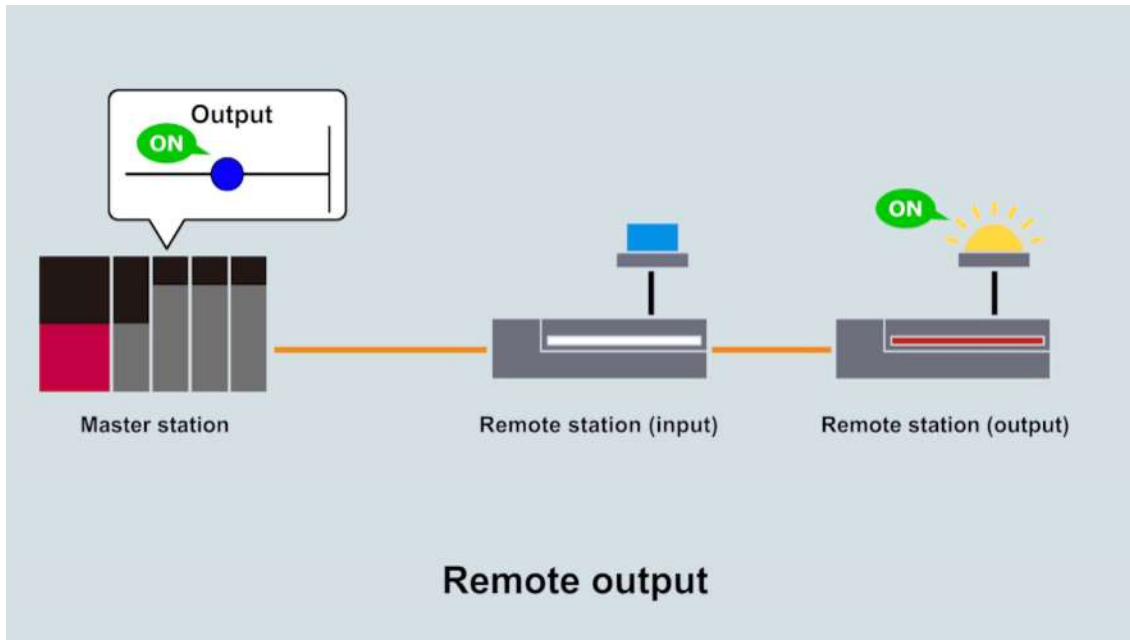

This status is transferred automatically. Programmers can create programs for the programmable controller without worrying about communication details.

This section describes cyclic transmission mechanism using the system as described in the previous page. Devices used in Mitsubishi Electric FA networks are divided into "link device" over the network and "device" of the programmable controller CPU.

The link devices for each station are updated by transferring data each other cyclically.

Data updating range is determined by assigned the link devices to the devices for each station.

The master station can use devices of the send/receive range in all stations. A remote station uses devices of the send/receive range of own station.

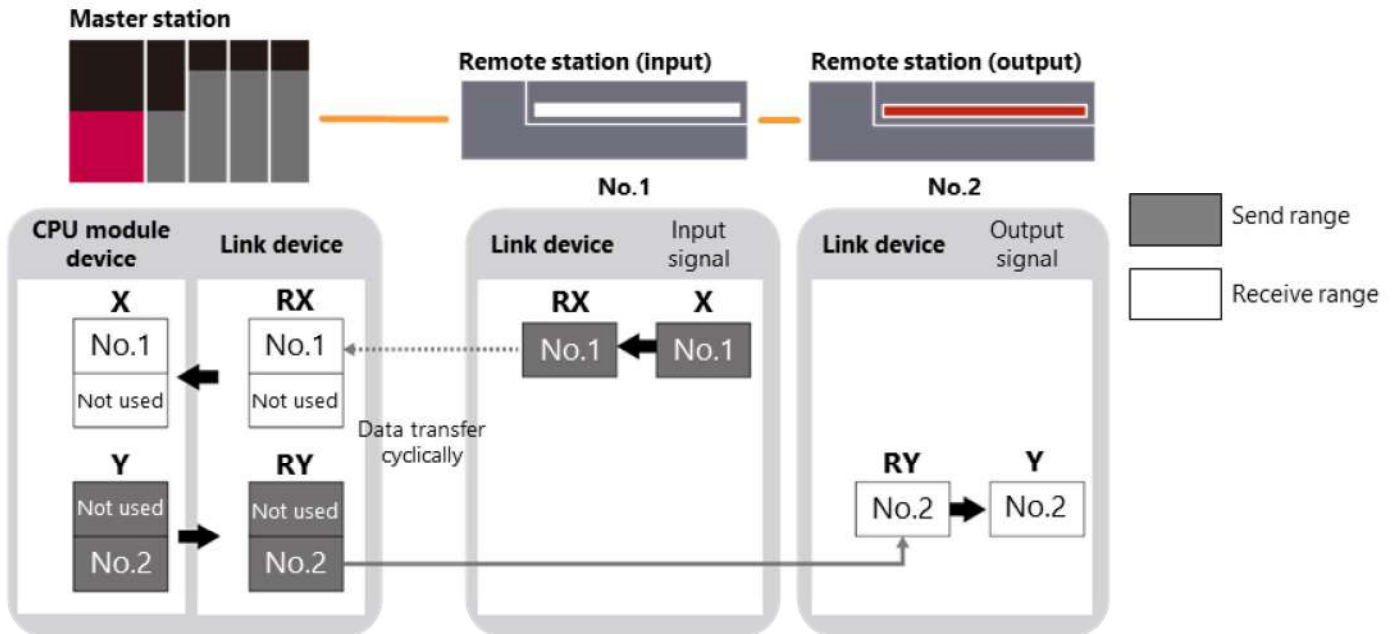

Cyclic transmission can transfer data reliably even if the number of connected stations on the network or communication frequency increases.

This chapter explained the fundamentals of FA networks.

Chapter 2 describes CC-Link IE TSN which is one of Mitsubishi Electric FA networks.

The contents of this chapter are:

- The features of FA networks
- FA network application
- Data communication methods of FA networks
- Cyclic transmission operation

Important points to consider:

FA networks	<ul style="list-style-type: none">• Since information is updated instantly, devices of the station which is located away from users can be controlled remotely.
FA network application	<ul style="list-style-type: none">• PLC to PLC network can exchange the same information between controllers such as a programmable controller CPU.• I/O can be arranged away from the controllers with minimum wiring. (Remote I/O)
Transmission system	<ul style="list-style-type: none">• Cyclic transmission always updates data according to the settings.• Transient transmission updates data each time according to the programs.• CC-Link IE TSN can use both the transmissions.
Link device	<ul style="list-style-type: none">• Data is updated on the network cyclically and the devices are used assigned to areas for each station.

CC-Link is an acronym for Control & Communication Link and aimed to merge between control and communications. CC-Link networks are designed as open networks used in FA environments.

"IE" in CC-Link IE TSN is an acronym for Industrial Ethernet.

"TSN" is an acronym for Time Sensitive Networking. It is the standard that extends standard Ethernet to enable its real-time communications

The types of CC-Link IE networks include the CC-Link IE TSN, CC-Link IE Controller Network and CC-Link IE Field Network.

2.1 Request for high-speed network connecting the entire factory

2.2 Integrated networks using CC-Link IE TSN

2.3 Reasons why networks can be integrated

2.4 Installation advantage of CC-Link IE TSN

2.5 Positioning of CC-Link IE TSN

2.1 Request for high-speed network connecting the entire factory

With the recent shift to Industrial Internet of Things (IIoT), the number of devices connected to networks and the amount of information on networks are increasing at production sites. Therefore, the network to be used is required high-speed and high-capacity to exchange a large amount of information instantly.

Click the play button to start the video.

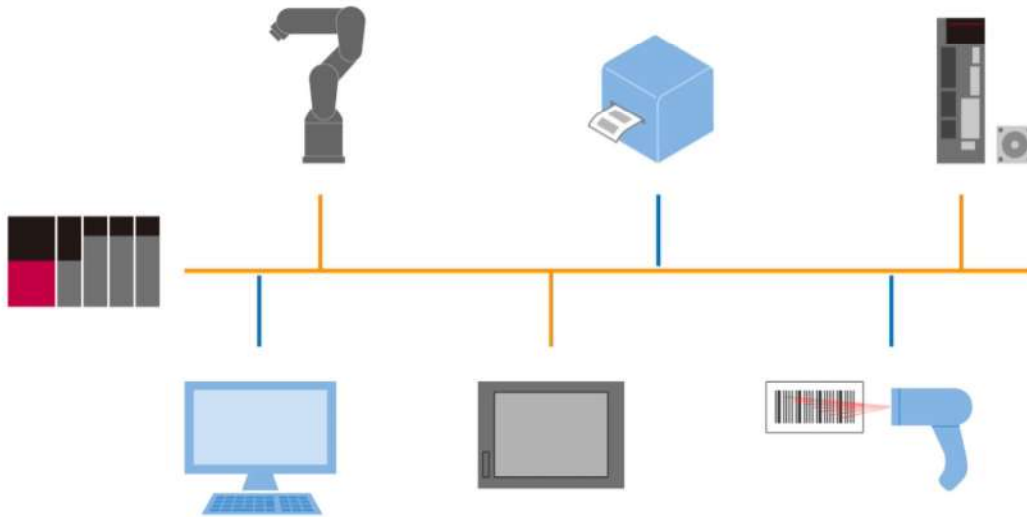

Control system and information system

In the existing FA network, the control system, information system, and drive system, must be configured separately. Therefore, when devices are included in the multiple systems, the systems must be configured for each corresponding system and wired multiple kinds of cables. To expand the systems, extension wiring is required from a distance if there is no network near the device. Wiring will take time and will be complicated because cables for three systems should be wired. When data is sent/received between different networks, users must write the programs or set the parameters to transfer the data between network modules.

CC-Link IE TSN integrates those network system as single network so that only one wiring is required. Since only one network module to be used is required, no program and parameter is required to transfer data between the network modules.

Click the play button to start the video.

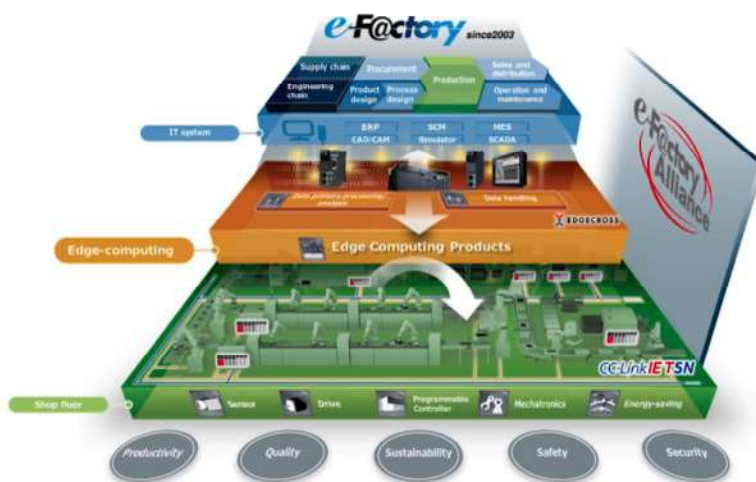

Division of communication band

This section describes the reasons why networks can be integrated.

Existing FA networks cannot maintain punctuality of control communications if information communications are mixed. Therefore, the networks have been divided physically.

On the other hand, CC-Link IE TSN can maintain punctuality of control communications by dividing communication bands between control and information communications.

Video explains the division of the communication band using a car traffic example.

Click the play button to start the video.

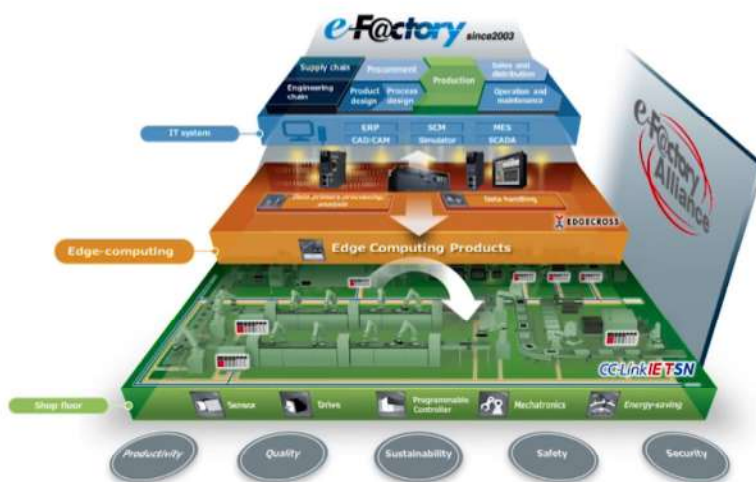

High-speed control by sending/receiving data simultaneously

Since the devices on CC-Link IE TSN can send/receive data simultaneously, communication cycle can be shorter and control can be more high-speed than existing FA networks.

This is an advantage for motion control which requires high-speed processing.

Click the play button to start the video.

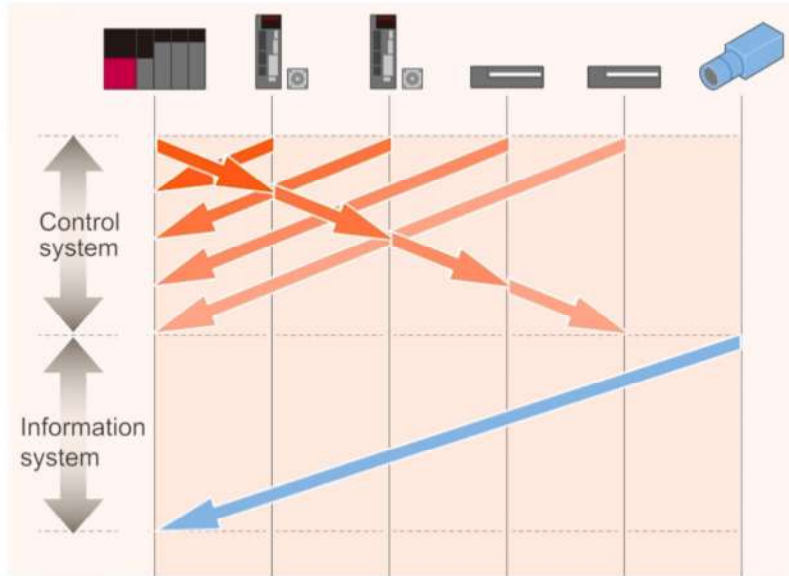

Specifying error causes by accurate time synchronization

Connected devices on CC-Link IE TSN are synchronized time at high-accuracy with $\pm 1\mu\text{s}$. They have time stamps in increments of 1ms.

Using the time stamp allows users to check the exact time that is occurring events or logs on the devices. This allows to specify error causes quickly if errors occur in a short time.

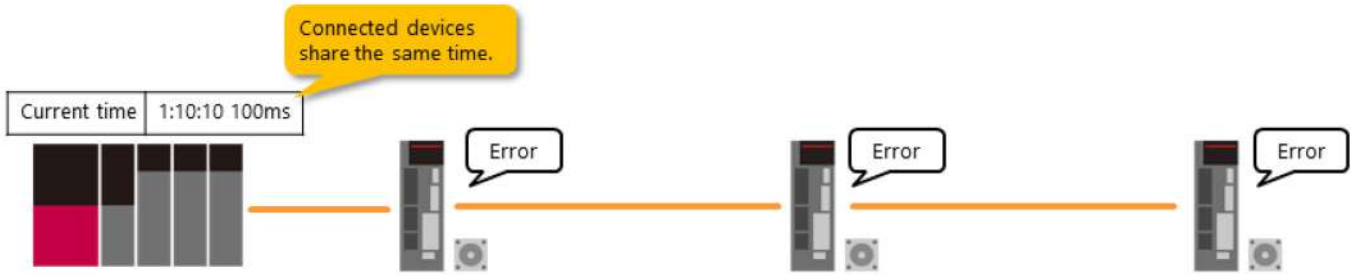

Analysis of error causes using engineering software

Remote station A			Remote station B			Remote station C		
Current time	1:10:10 100ms		Current time	1:10:10 100ms		Current time	1:10:10 100ms	
Event occurrence history	Error	1:05:50s 100ms	
	Error	1:05:50s 103ms	Event occurrence history

	Error	1:05:50s 105ms	

Start of an error

Integrated management of networks using the Ethernet monitoring tool

CC-Link IE TSN supports the SNMP (Simple Network Management Protocol) which is standard specifications to monitor Ethernet. Using the Ethernet monitoring tool that supports the SNMP enables the integrated management of information devices and FA devices that supports CC-Link IE TSN.

Since the status of information devices or FA devices such as the server and switching hubs can be monitored comprehensively, error causes can be easily identified on the network and the recovery time can be shortened.

Ethernet monitoring tool can be obtained as the general software.

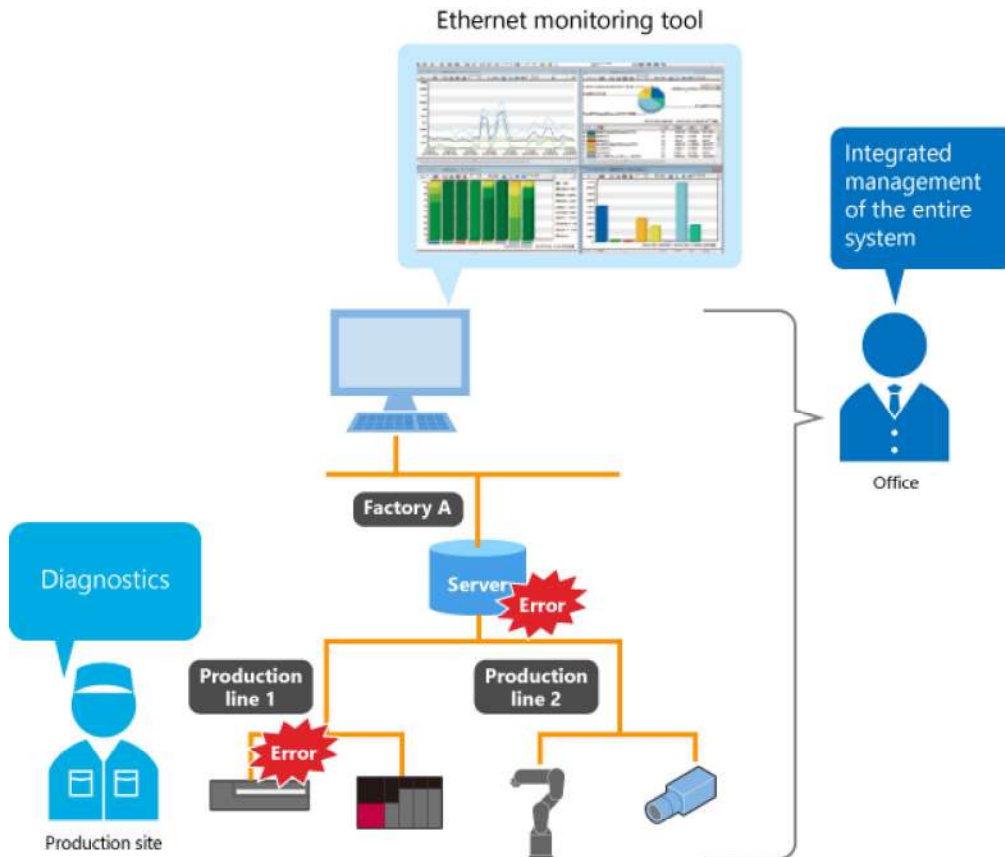

This section describes the primal networks in Mitsubishi Electric FA networks and their applications.

CC-Link IE TSN is FA networks that can be used regardless of the system size. CC-Link IE TSN takes all roles of the existing Mitsubishi Electric FA networks, which are control system network (CC-Link IE Controller Network, CC-Link IE Field Network), information system network (Ethernet), and drive system network (motion network).

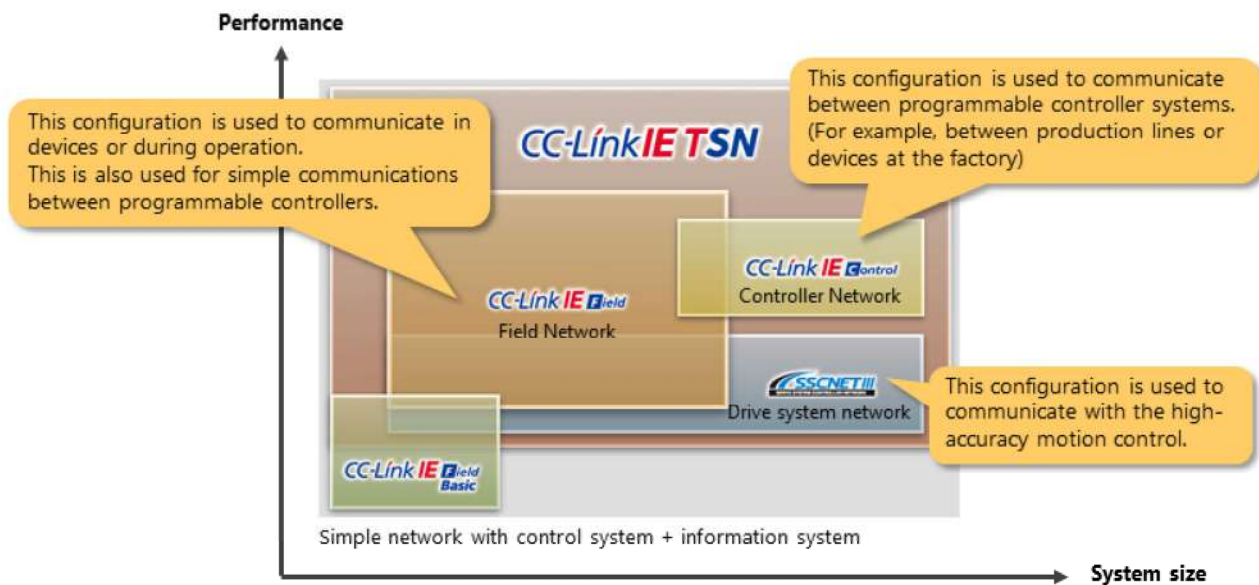

The contents of this chapter are:

- Current of FA industry
- Features of CC-Link IE TSN
- Installation advantage of CC-Link IE TSN
- Positioning of CC-Link IE TSN

Important points to consider:

Features of CC-Link IE TSN	<ul style="list-style-type: none"> • Since a network is high-speed and high-capacity, a lot of connected devices can exchange information instantly. • Networks of the control system, drive system, and information system can be integrated as one network.
Integrated networks	<ul style="list-style-type: none"> • The time to detect an error cause can be shortened for start-up or maintenance. • The time to wire the cables can be shortened at a network installation or extension.
Punctuality	<ul style="list-style-type: none"> • CC-Link IE TSN maintains punctuality of control communications if information communications are mixed.
Time synchronization	<ul style="list-style-type: none"> • Errors can be verified accurately due to the connected devices having accurate time stamp.
SNMP	<ul style="list-style-type: none"> • The SNMP compliant with the standard specifications to monitor Ethernet and the entire network including a server, switch, and wiring can be managed comprehensively using the software tool compliant with the standards.
Positioning	<ul style="list-style-type: none"> • CC-Link IE TSN takes all roles of the existing Mitsubishi Electric FA networks.

This section describes required knowledge to design the CC-Link IE TSN system.

3.1 Station types and functions

3.2 Connectable devices

3.3 Network topologies

3.4 Required settings for system start-up

This section describes the station types and functions that configures CC-Link IE TSN.

Network on CC-Link IE TSN is configured one master station and one or more slave stations.

Master station

A station that controls the entire network. This station contains the network settings. Data communications with all stations can be performed.

Slave station

A generic term for the stations controlled by the master station.

Local station

A station that exchanges information with the master station and other local stations and performs control autonomously. This station is used to perform distributed control for controllers.



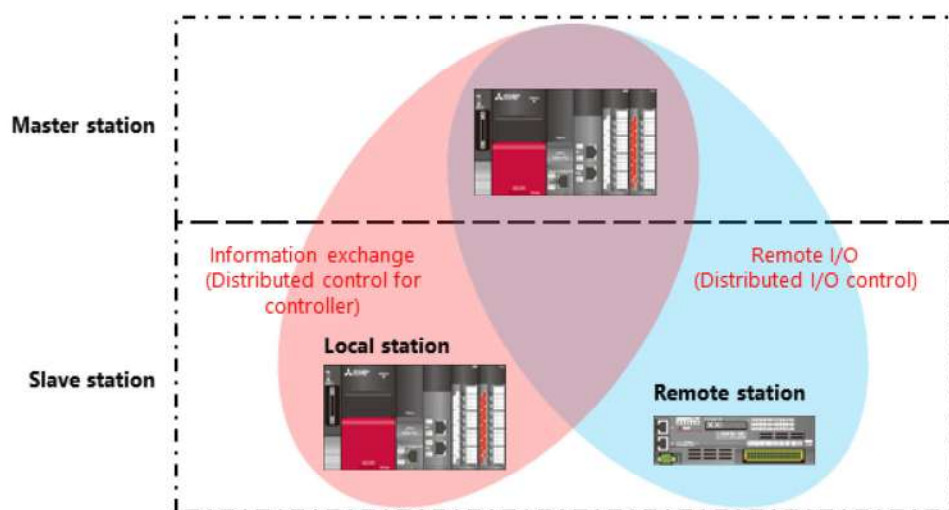

Remote station

A station that performs distributed I/O. This station is controlled by the master station.



The system of the master station and remote stations is described in Chapter 4 and the system of the master station and local stations is described in Chapter 5.

The following table lists the connectable devices with CC-Link IE TSN.

Station type		Device type	
Master station		Master/local module	 RJ71GN11-T2
		Motion module	 RD78G、RD78GH
Slave station	Local station	Use the same module type as the master station for a local station.	
	Remote station	Block type remote module	
		<ul style="list-style-type: none"> · HMI (GOT) · Inverter · Servo amplifier or other devices 	

Select a network topology after setting stations to be used.

Line, star, or ring topology can be used for CC-Link IE TSN.

Using different topology enables the network configuration to suit your environment.

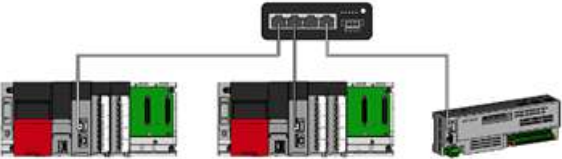
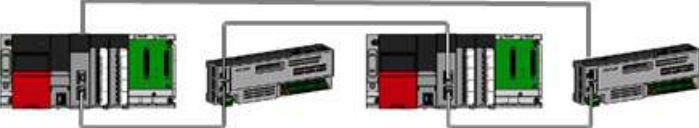
	Topology	Feature
Line topology	<p>A network is configured with a line between modules.</p> 	<p>A network can be configured with minimum wiring.</p>
Star topology	<p>A network is configured through a switching hub.</p> 	<ul style="list-style-type: none"> • Highly scalable • Devices to be added easily
Ring topology (not currently supported)	<p>Network is configured as a ring.</p> 	<p>High reliability</p>

By coexisting line and star topologies, a network can be configured with more flexible wiring.

This course describes network configurations using **line topology**.

This section describes required settings for system start-up with the system of the distributed I/O control. The following three settings are required.

Settings for external devices to be communicated

- Station type: Set the functions to be used in the stations.
- IP address: Set end values so that each address has a different number in the network configuration.

Settings for configuring slave stations and assigning link devices to the station (Network configuration settings)

Settings for connecting CPU module devices to the link devices (Refresh settings)

Station type	Master station	Remote station	Remote station
IP address	192.168.3.253 (Initial value)	192.168.3.1	192.168.3.2
Network configuration settings			
	RJ71GN11-T2	NZ2GN2S1-32D	NZ2GN2S1-32T
Refresh settings	CPU module device · X: 64 points, Y: 64 points · W: 16 points	Link device · RX/RX: 32 points · RWr/RWw: 4 points	Link device · RX/RX: 32 points · RWr/RWw: 4 points

This section explained the system design.

The next chapter describes how to start up the system.

The contents of this chapter are:

- Station types and functions
- Connectable devices
- Topology
- Required settings for system start-up

Important points to consider:

Station type	<ul style="list-style-type: none">• Stations are broadly divided into the master station and slave stations. The slave stations includes local stations and remote stations.• Local stations perform distributed control for controllers and exchange the same information.• Remote stations perform distributed I/O control.
Topology	<ul style="list-style-type: none">• In a line topology, a network can be configured with minimum wiring.• In a star topology, a highly scalable network can be configured and devices added easily.• In a ring topology, a highly reliable network can be configured.• Using different topology enables the network configuration to suit your environment.

This chapter describes how to start up the system with the master station and remote stations.

- 4.1 System operation
- 4.2 Required settings for system start-up
- 4.3 Wiring
- 4.4 IP address settings of remote stations
- 4.5 Module parameter settings
- 4.6 Checking the connection
- 4.7 Program and operation check
- 4.8 Network diagnostics

Distributed I/O control

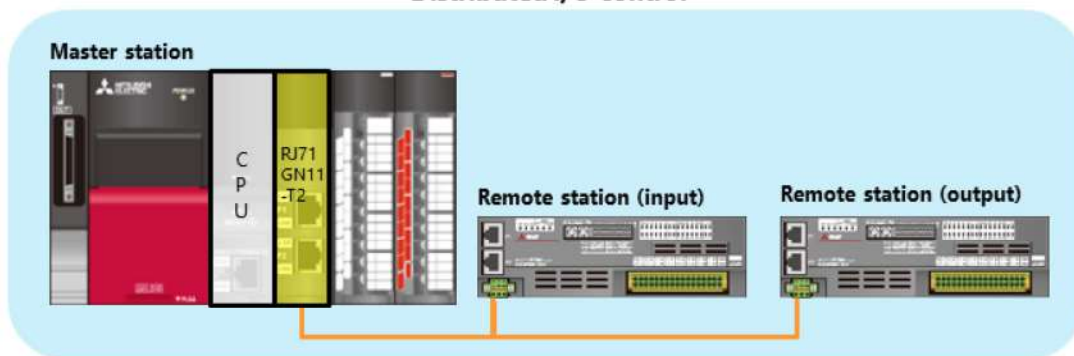

This section describes the operation of the system to be started.

- When the switch of the remote station (input) is turned on, the LED in the master station is on.
- When the switch of the master station is turned on, the LED in the remote station (input) is on.

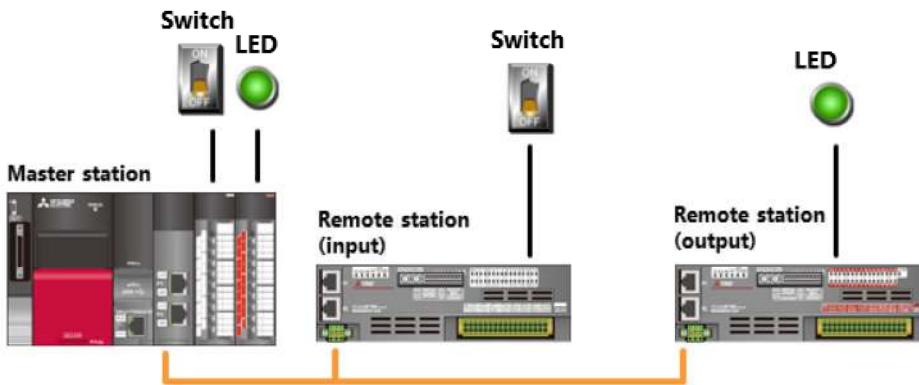

This section describes the setting procedures with checking the **required settings for the system start-up** described in Chapter 3.

Station type	Master station	Remote station (input)	Remote station (output)
IP address	192.168.3.253	192.168.3.1	192.168.3.2
Network configuration settings			
	RJ71GN11-T2	NZ2GN2S1-32D	NZ2GN2S1-32T
Refresh settings	CPU module device X: 64 points 1000 to 103F Y: 64 points 1000 to 103F	Link device RX: 32 points 0000 to 001F RY: 32 points 0000 to 001F	Link device RX: 32 points 0020 to 003F RY: 32 points 0020 to 003F

The following figure shows the module configuration of the master station.

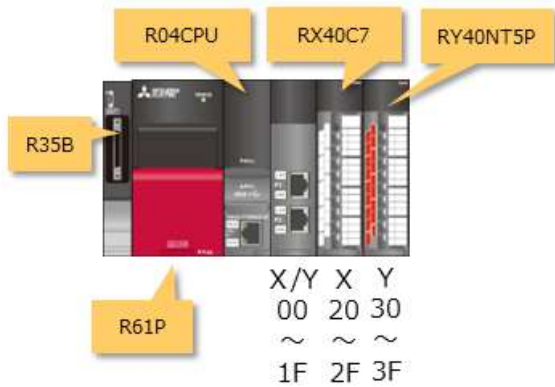

CC-Link IE Field Network modules have two connection ports, P1 and P2.

The network modules operate in the same manner regardless of either port which is used for cable connections.

However, determining a particular rule, such as connection from port P1 to port P2 of the next device in the chain, helps make cable wiring and post-wiring operation checks more efficient.

Master station

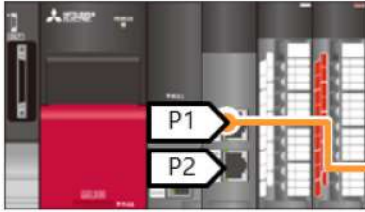

Remote station (input)



Remote station (output)



Block type remote modules have a rotary switch on the front side to set the IP address.

Switch a rotary switch (IP/STATION switch x 1) on the right with the same value as the end value of the IP address.

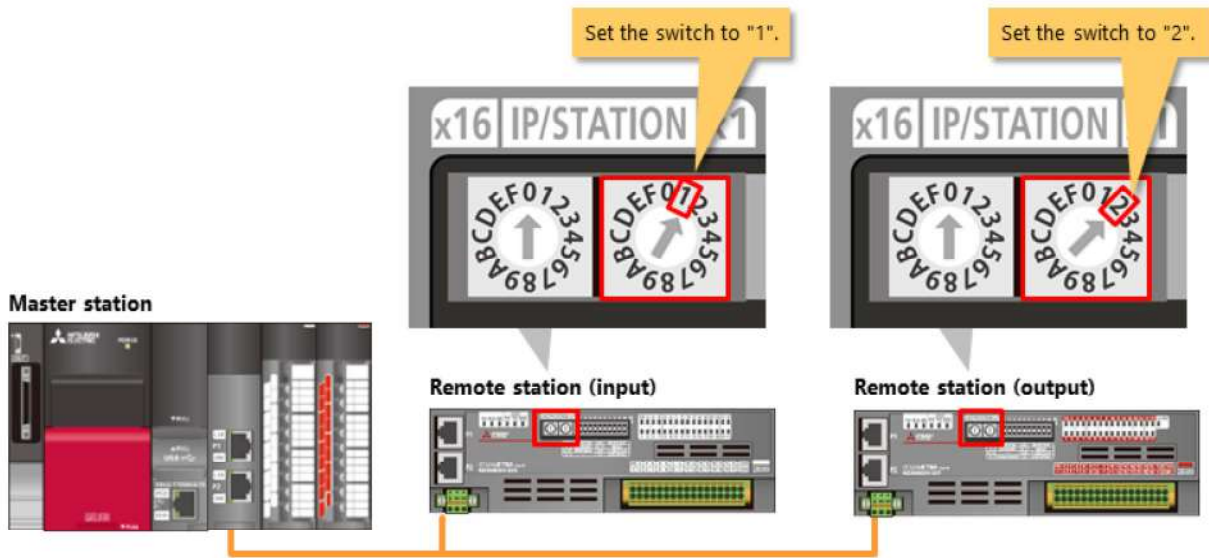

Station type	Master station	Remote station (input)	Remote station (output)
IP address	192.168.3.253	192.168.3.1	192.168.3.2

Set the module parameters using the engineering software GX Works3.

In the module configuration diagram, configure a module that provides the network functionality to the slot next to the CPU module.

As CC-Link IE TSN is used in this course, select [RJ71GN11-T2] in the network module list.

If you have actual modules and devices, select [Read Module Configuration from PLC] from [Online] to reflect the actual modules and devices configuration to the module configuration diagram.

The image shows a screenshot of the GX Works3 software interface. On the left, a rack configuration diagram displays slots for POW, CPU 0, 1, 2, 3, and 4. The CPU 0 slot is highlighted with a red box and labeled 'CPU module'. A red arrow points from the 'RJ71GN11-T2' entry in the network module list on the right to the CPU 0 slot. A yellow callout box contains the text: 'Configure the slot next to the CPU module with [RJ71GN11-T2] under "Network Module"'. The network module list on the right includes the following entries:

Module Name	Description
RJ51AW12AL	AnyWireASLINK Master Module
RJ61BT11	CC-Link
RJ71BAC96	BACnet
RJ71CN91	CANopen module(CANopen)
RJ71GN11-T2	CC-Link IE TSN
RJ71GF11-T2(MR)	CC IE Field(Redundant master)
RJ71GF11-T2(SR)	CC IE Field(Redundant slave)
RJ71GP21-SX	CC IE Control
RJ71GP21-SX(R)	CC IE Control(Redundant system)
RJ71GP21S-SX	CC IE Control (with external power supply)
RJ71GP21S-SX(R)	CC IE Control (with external power supply, Redundant system)

Set the station type and IP address of the TSN master/local module to the master station.

From the "Navigation" window, select [Parameter], then [Module Information], then [0000:RJ71GN11-T2], and then [Module Parameter]. Open the setting window from [Module Parameter] and configure [Required Settings] as shown below.

Setting Item List

Setting Item

Item	Setting
Station Type	
Station Type	Master Station
Network No.	
Network No.	1
Parameter Setting Method	
Setting Method of Basic/Application Settings	Parameter Editor
Station No./IP Address Setting	
Station No./IP Address Setting Method	Parameter Editor
Station No.	0
IP Address	
IP Address	192.168.3.253
Subnet Mask	. . .
Default Gateway	. . .

Set the station type to [Master Station].

Different numbers are assigned to the end so that each IP address is distinguished/unique in the network configuration. The end value of the master station remain the initial value 253.

Station type	Master station	Remote station (input)	Remote station (output)
IP address	192.168.3.253	192.168.3.1	192.168.3.2

Set the configuration of stations connected to the network.

On the setting window, select [Module Parameter], then [Basic Settings], then [Network Configuration Settings], and then [Detailed Setting] to open the [CC-Link IE TSN Configuration] window.

Select modules to be added to a slave station from the module list and drag and drop the slave station modules onto the diagram. Then, the slave station modules are registered.

(4) The range of link devices used in the slave stations is automatically set.

No.	Model Name	STA#	Station Type	Motion Control Station	RX Setting			RY Setting			RW _r Setting			RW _w Setting			
					Points	Start	End	Points	Start	End	Points	Start	End	Points	Start	End	
0	Host Station	0	Master Station														
1	NZ2GN2S1-32D	1	Remote Station	<input type="checkbox"/>	32	0000	001F	32	0000	001F	4	0000	0003	4	0000	0003	
2	NZ2GN2S1-32T	2	Remote Station	<input type="checkbox"/>	32	0020	003F	32	0020	003F	4	0004	0007	4	0004	0007	

(3) Once the modules have been arranged, the row to enter the module settings is added.

(1) Drag and drop slave station modules from the Module List onto the diagram.

(2) The network configuration is illustrated in an easy-to-understand graphical format.

Network configuration settings

RJ71GN11-T2 NZ2GN2S1-32D NZ2GN2S1-32T

4.5.3

Refresh settings

CPU module devices and link devices must be assigned to determine the ranges used for data transfer during link refresh. The following figure shows the assignment ranges of each station link device using the cyclic transmission diagram described in Chapter 1.

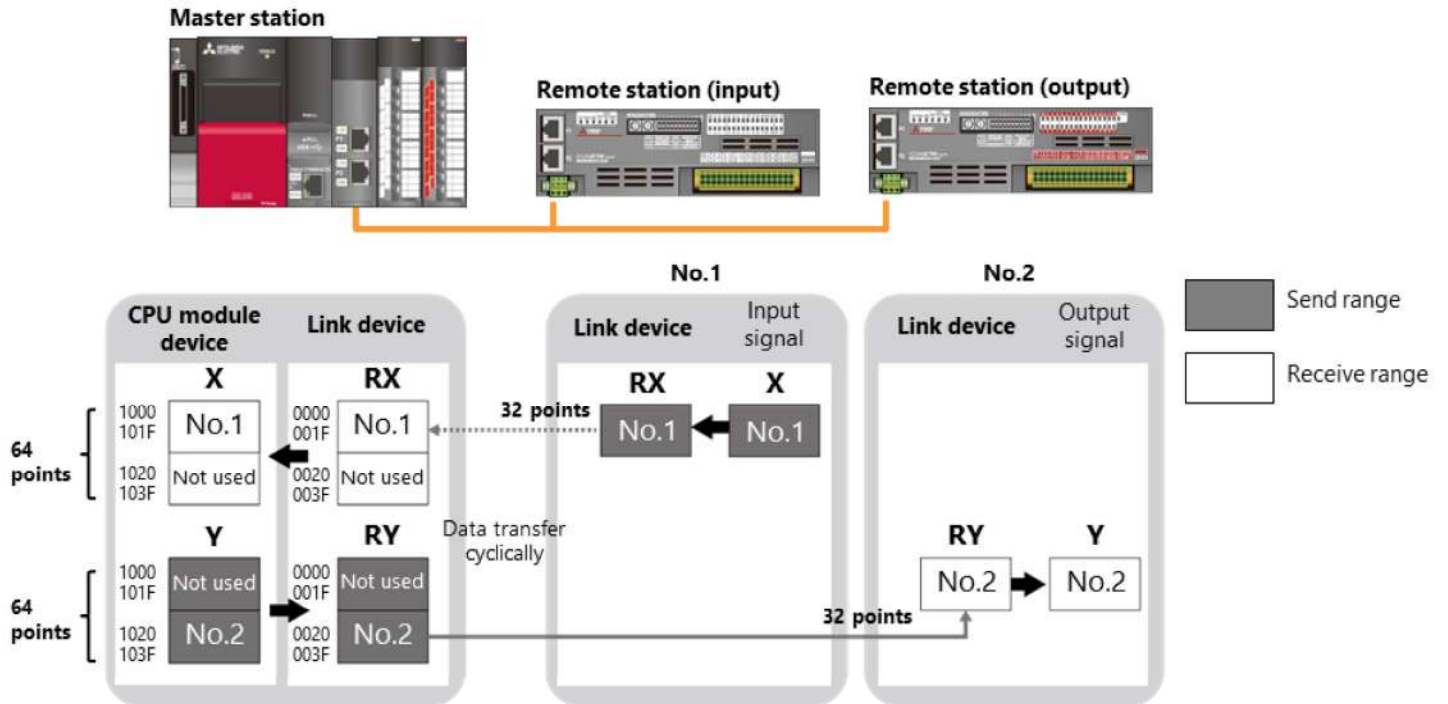

	RJ71GN11-T2	NZ2GN2S1-32D	NZ2GN2S1-32T
Refresh settings	CPU module device X: 64 points 1000 to 103F Y: 64 points 1000 to 103F	Link device RX: 32 points 0000 to 001F RY: 32 points 0000 to 001F	Link device RX: 32 points 0020 to 003F RY: 32 points 0020 to 003F

On the setting window, select [Module Parameter], then [Basic Settings], then [Refresh Setting], and then [Detailed Setting] to open the refresh setting window. Input the range used for each link device.

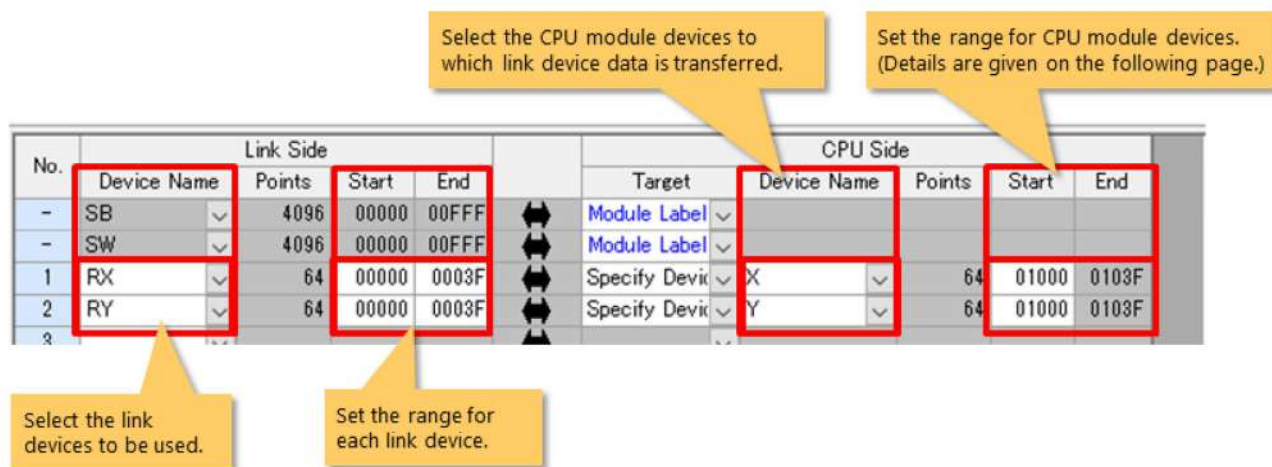

No.	Link Side				Target	CPU Side			
	Device Name	Points	Start	End		Device Name	Points	Start	End
-	SB	4096	00000	00FFF	Module Label				
-	SW	4096	00000	00FFF	Module Label				
1	RX	64	00000	0003F	Specify Devic	X	64	01000	0103F
2	RY	64	00000	0003F	Specify Devic	Y	64	01000	0103F

	RJ71GN11-T2	NZ2GN2S1-32D	NZ2GN2S1-32T
Refresh settings	CPU module device X: 64 points 1000 to 103F Y: 64 points 1000 to 103F	Link device RX: 32 points 0000 to 001F RY: 32 points 0000 to 001F	Link device RX: 32 points 0020 to 003F RY: 32 points 0020 to 003F

*Since the system described in this chapter does not use a word device, no remote register (W) is set.

Module parameter settings are completed.

*Make sure to write parameters to the CPU module after the settings are completed.

Device range assigned to the CPU module

In the refresh settings, the start device number is assigned to the CPU module from 1000. If not, other modules on the base unit may use the lower device number than 1000.

CPU Side				
ret	Device Name	Points	Start	End
abel				
abel				
Devic	X	64	01000	0103F
Devic	Y	64	01000	0103F

When the devices are assigned to the CPU modules, the area is determined based on the following CPU module specifications.

- Number of I/O points: Number of points that can be used by modules installed on the base unit
- Number of I/O device points: Range of usable devices including networks

MELSEC iQ-R Series CPU modules have the following specifications.

- Number of I/O points: X/Y0000 to FFFH
- Number of I/O device points: X/Y0000 to 2FFFH

The areas between 1000 to 2FFFH can be assigned for refresh of link devices as they do not conflict with areas used for modules installed on the base unit.

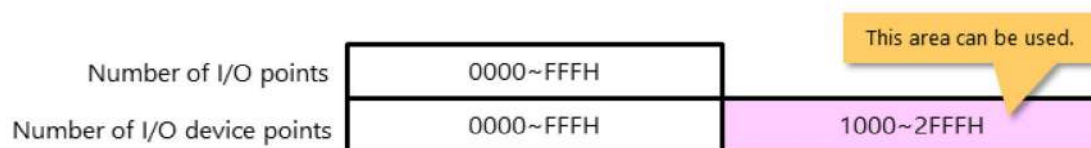

When the network operates normally, the data link LEDs on the front of modules are on.

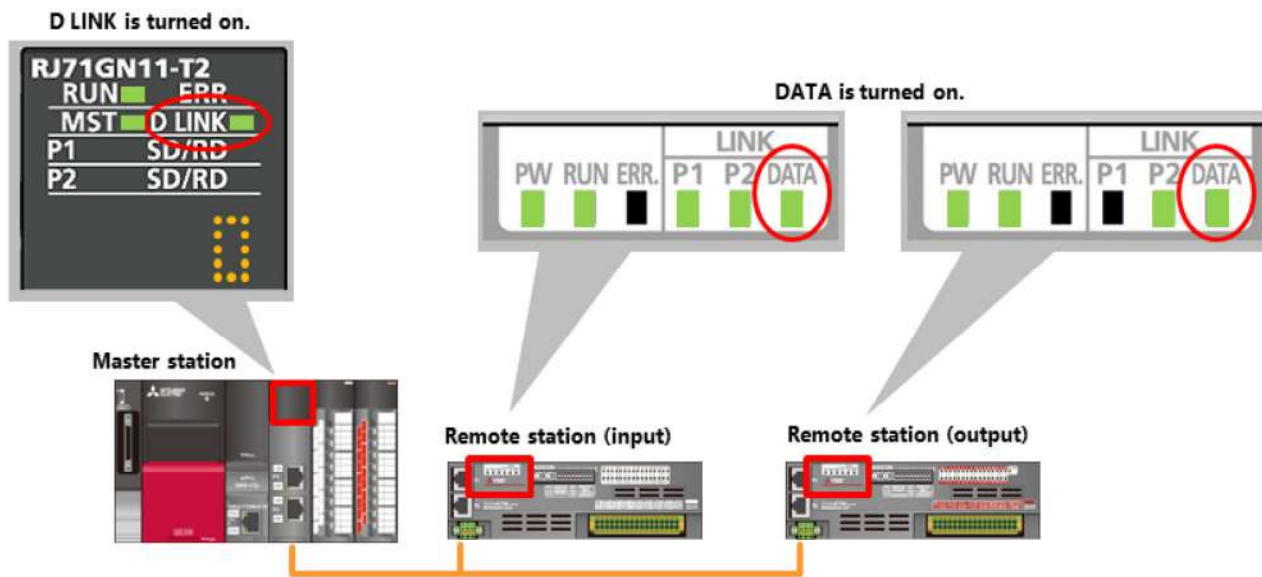

If not, check the network status using the network diagnostics. Details on the network diagnostics are described in Section 4.8.

This section describes the remote I/O control programs.

Press the  button to check the operation.

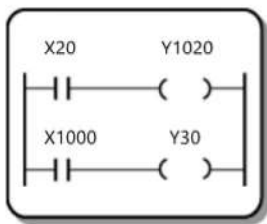
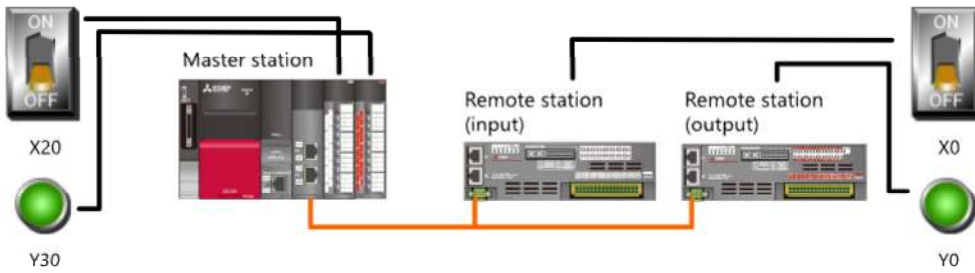

Master station

Remote station

- (1) Turn on the switch X20 at the master station.
- (2) Y1020 is on by the sequence program.
- (3) The status is transmitted via the network.
- (4) The LED Y0 of the remote station 2 is turned on.



Click the **switch** in the diagram to check the status of the program data transfer shown in the previous page.
 The CPU module handles input/output of the block type remote module as though input/output of a module installed on the base unit.
 The I/O devices assigned to the remote station are constantly and automatically refreshed by link refresh.

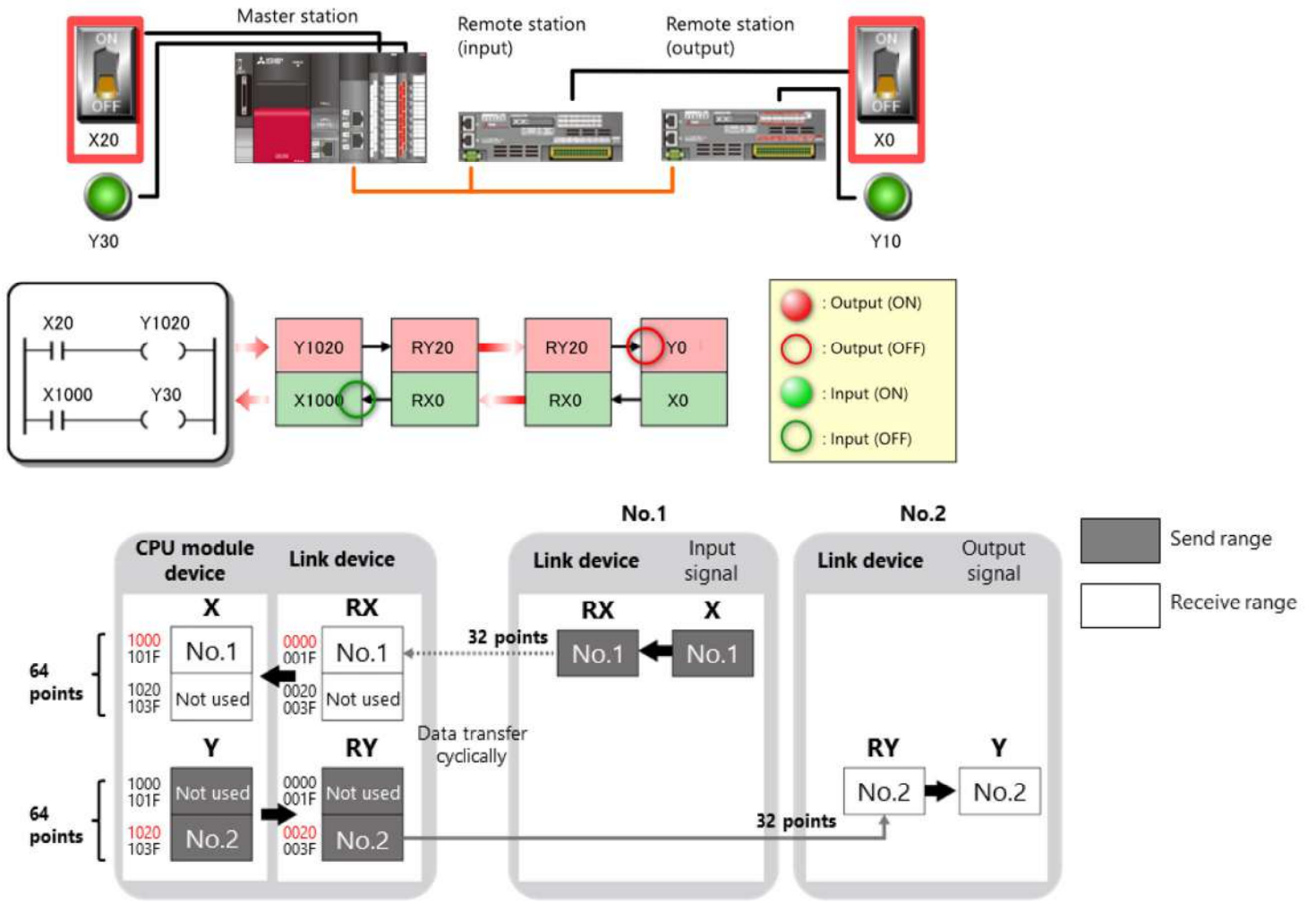

If the network does not seem to be operating normally, execute [CC-Link IE TSN/CC-Link IE Field Diagnostics] from the [Diagnostics] menu of engineering software.

CC-Link IE TSN diagnostics graphically shows the actual network wiring. This helps you quickly identify an error location and troubleshoot an issue.

The screenshot displays the CC-Link IE TSN diagnostics software interface. The main window is titled "Select Diagnostics Destination" and shows the following information:

- Module:** Module 1 (Network No. 1)
- Station No.:** 1
- Network Status:**
 - Total Slave Stations (Parameter): 2
 - Total Slave Stations (Connected): 1
 - Comm. Period Interval Value: 1000 us
 - Number of Station Errors Detected: 1
- Connected Sta.:** Master:0, Remote:1, Remote:2. A diagram shows the network topology with a red starburst indicating a disconnection at Remote:1.
- Selected Station Communication Status Monitor (N22GN251-32D):**
 - Sta. No. 1: Error
 - Network: CC IE TSN
 - Authentication Class: B
 - MAC Address: 58-52-8A-EF-96-42
 - IP Address: 192.168.3.1
 - A detailed diagram of the station's network ports (P1, P2) shows a red starburst on P1 and a green dot on P2, with the text "PORT1 Cable Disconnected..." below it.

The "Monitor Status" window is open, displaying the following information:

- Monitor Status:** Monitoring (Start Monitoring, Stop Monitoring)
- Detailed Information:**
 - Own Station Connecting Status: Normal (Cable Disconnected on PORT1 side, Communicating on PORT2 side)
 - Cable Disconnection Detection Counts on PORT1 Side: 4
 - Data Link Stop Factors: Normal Communication or Power On
- Error Factor:**
 - The cable connected to the PORT1 of the own station has been disconnected.
 - No cable is connected to the PORT1 of the own station.
 - When the PORT1 of the own station is not in use: In the PORT2 network, the total number of slave stations set in the master station parameters differs from the actual number of modules connected to the network.
- Troubleshooting:**
 - Connect an unbroken cable to the PORT1 of the own station.
 - When the PORT1 of the own station is not in use, connect the slave stations to the PORT2 network so that the total number of stations connected matches the total number of slave stations set in the master station parameters.
 - If the above conditions are normal, the network module may be in failure. Replace the network module.

The contents of this chapter are:

- Procedures and settings for system start-up of the master station and remote stations
- Network diagnostics

Important points to consider:

Connection ports for the network cables	<ul style="list-style-type: none">• The network modules operate in the same manner regardless of either port which is used for cable connections.
Role of IP address	<ul style="list-style-type: none">• Communication destinations are identified.
Refresh settings	<ul style="list-style-type: none">• For the devices assigned to the CPU module, set the different range from the actual devices which have already used by the modules on the base unit.
Module LED diagnostics	<ul style="list-style-type: none">• Primary diagnostics of the network status can be performed by checking the LED on/off state.
CC-Link IE TSN diagnostics	<ul style="list-style-type: none">• The actual network wiring is shown on engineering software so that users can quickly identify an error location and troubleshoot an issue.

This chapter describes system start-up of the master station and local stations.

- 5.1 System operation
- 5.2 Data update for cyclic transmission (between programmable controllers)
- 5.3 Required settings for system start-up
- 5.4 Wiring
- 5.5 Module parameter settings
- 5.6 Checking the connection
- 5.7 Program and operation check

Distributed control for controller

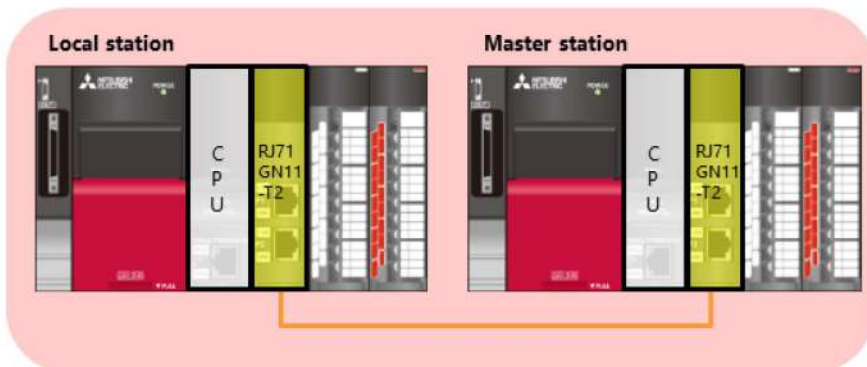

This section describes the operation schematic of the system to be started.

Turning on or off switches of the own station enables LED indications or digital displays on the destination station.

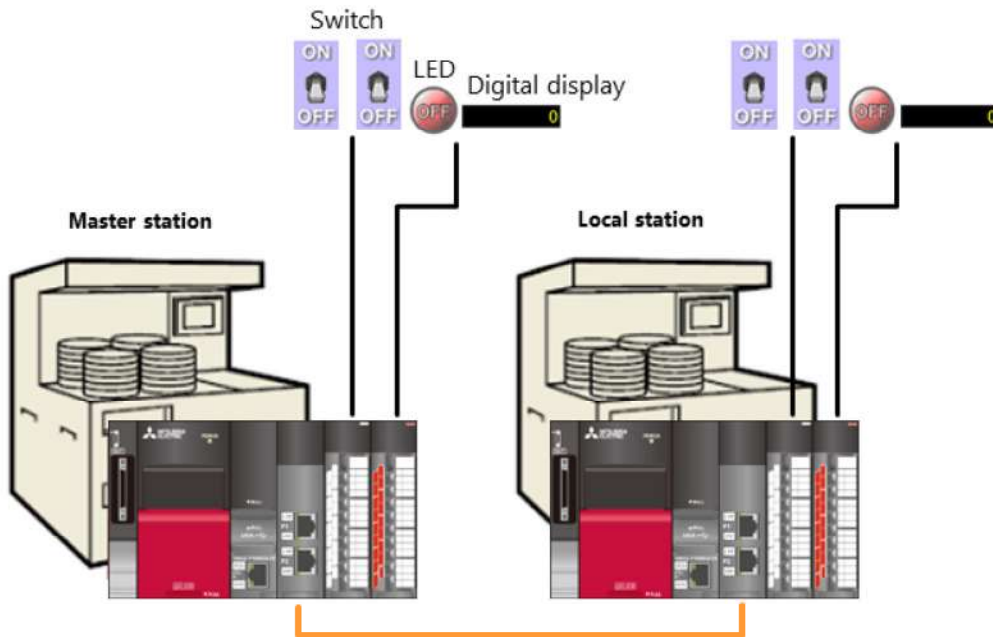

This section describes data update for cyclic transmission in PLC to PLC network before system configuration. The remote I/O network described in Chapter 4 uses RX and RY (bit) and RWr and RWw (word) for link devices. In the PLC to PLC network, LB (link relay) and LW (link register) are used for link devices. LB and LW are updated by transferring data cyclically as well as RX, RY, RWr, and RWw. However they have difference as follows.

- RX, RY, RWr, and RWw input or output by each device, however, LB and LW input and output both in single device. (Information is exchanged by the range of each station)
- RX, RY, RWr, and RWw switch input to output between the CPU module and remote I/O, however, LB and LW do not switch.

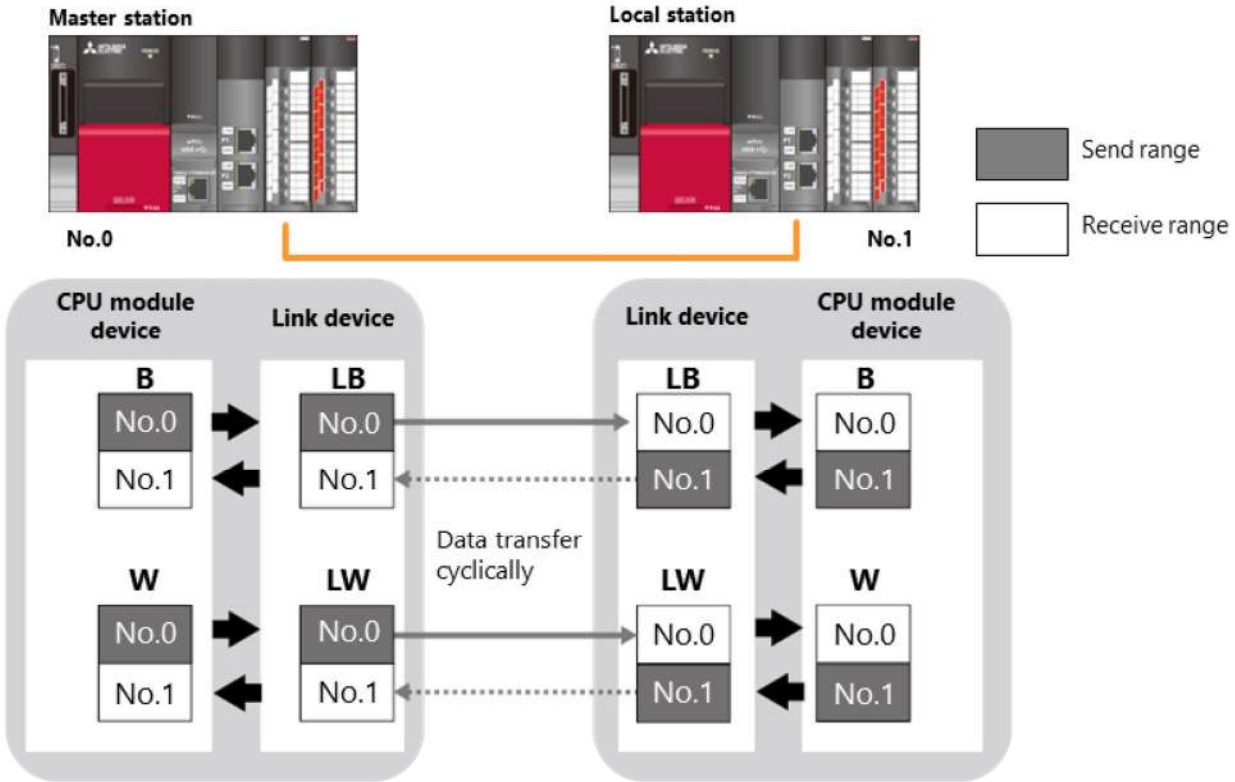

This section describes the system to be configured. The system is configured with the master station and local stations.

Station type	Master station	Local station
IP address	192.168.3.253	192.168.3.1
Network configuration settings	 <p style="text-align: center;">Master station Local station</p>	
	RJ71GN11-T2	RJ71GN11-T2
Refresh settings	CPU module device B: 512 points 0000 to 01FF W: 512 points 0000 to 01FF	Link device LB: 512 points 0000 to 01FF LW: 512 points 0000 to 01FF

The following figure shows the common module configuration of the master station and local stations.

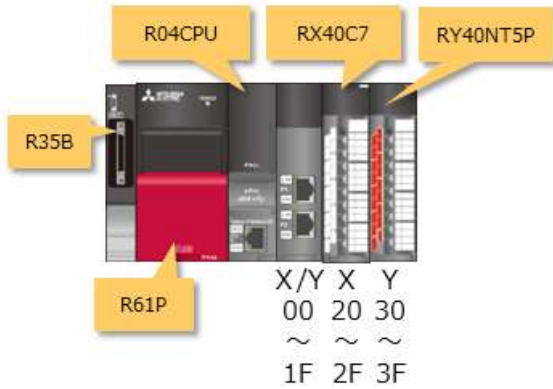

CC-Link IE TSN modules have two connection ports, P1 and P2.

The network modules operate in the same manner regardless of either port which is used for cable connections.

However, determining a particular rule, such as connection from port P1 to port P2 of the next device in the chain, helps make cable wiring and post-wiring operation checks more efficient.

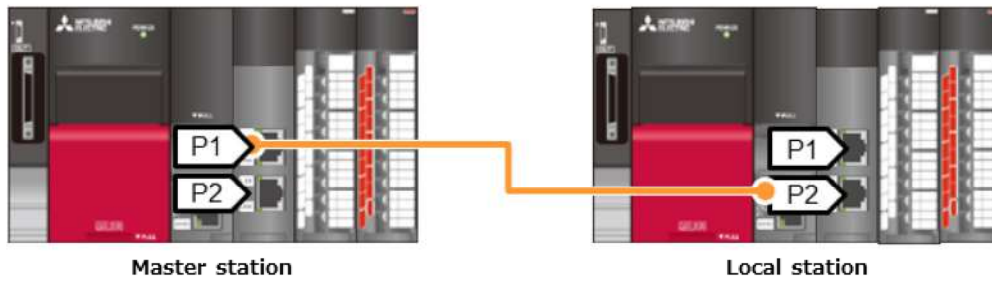

Set the module parameters using the engineering software GX Works3.

In the module configuration diagram, configure a module that provides the network functionality to the slot next to the CPU module.

As CC-Link IE TSN is used in this course, select [RJ71GN11-T2] in the network module list.

If you have actual modules and devices, select [Read Module Configuration from PLC] from [Online] to reflect the actual modules and devices configuration to the module configuration diagram.

Set the same settings for both the master station and local stations.

Energy Measuring Module	
Information Module	
Network Module	
RJ51AW12AL	AnyWireASLINK Master Mc
RJ61BT11	CC-Link
RJ71BAC96	BACnet
RJ71CN91	CANopen module(CANope
	DeviceNet master/slave mo
	CC IE Field
RJ71GF11-T2(LN)	CC IE Field(Redundant line :
RJ71GF11-T2(MR)	CC IE Field(Redundant mast
RJ71GF11-T2(SR)	CC IE Field(Redundant slave
RJ71GN11-T2	CC-Link IE TSN
RJ71GP21-SX	CC IE Control
RJ71GP21-SX(R)	CC IE Control(Redundant sy
RJ71GP21S-SX	CC IE Control (with external
RJ71GP21S-SX(R)	CC IE Control (with external

The station types and IP addresses for the CC-Link IE TSN module must be set to the master station and a local station.

From the "Navigation" window, select [Parameter], then [Module Information], then [0000_RJ71GN11-T2], and then [Module Parameter]. Open the setting window from [Module Parameter] and configure [Required Settings] as shown below.

	Master station	Local station
Station Type		
Station Type	Master Station	Local Station
Network No.		
Network No.	1	1
Parameter Setting Method		
Setting Method of Basic/Application Settings	Parameter Editor	Parameter Editor
Station No./IP Address Setting		
Station No./IP Address Setting Method	Parameter Editor	Parameter Editor
Station No.		
Station No.	0	1
IP Address		
IP Address	192 . 168 . 3 . 253	192 . 168 . 3 . 1
Subnet Mask
Default Gateway

Different numbers are assigned to the end so that each IP address is distinguished/unique in the network configuration.
 The end value of the master station remain the initial value 253.
 The end value of a local station remain the initial value 1.

Station type	Master station	Local station
IP address	192.168.3.253	192.168.3.1

On the setting window, select [Module Parameter], then [Basic Settings], then [Network Configuration Settings], and then [Detailed Setting] to open the [CC-Link IE TSN Configuration] window.

Select modules to be added to a slave station from the module list and drag and drop the slave station modules onto the diagram. Then, the slave station modules are registered.

No.	Model Name	STA#	Station Type	RX Setting Points	RY Setting Points	RWr Setting Points	RWw Setting Points
0	Host Station	0	Master Station				
1	RJ71GN11-T2	1	Local Station	32	32	16	16

(4) Set the range of link devices (LB/LW) to be used of each station manually. More details will be explained on the next page.

(3) Once the modules have been arranged, the row to enter the module settings is added. RX, RY, RWr, and RWw are not used in this chapter.

(2) The network configuration is illustrated in an easy-to-understand graphical format.

(1) Drag and drop slave station modules from the Module List onto the diagram.

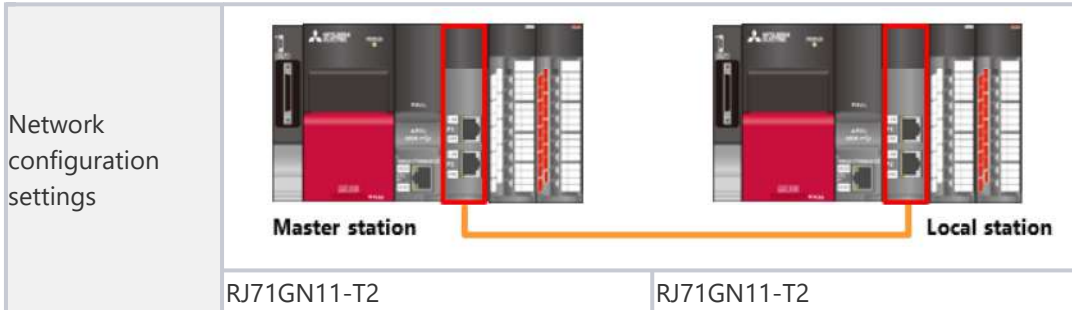

Input columns for LB and LW are displayed by clicking the [Detailed Display] button. Compared to RX, RY, RWr, and RWw, LB and LW are input manually.

The screenshot shows the 'CC-Link IE TSN Configuration' software interface. The main window is in 'Detailed Display' mode, showing a table of station configurations:

No.	Model Name	STA#	Station Type	RX Setting Points	RY Setting Points	RWr Setting Points	RWw Setting Points
0	Host Station	0	Master Station				
1	RJ71GN11-T2	1	Local Station	32	32	16	16

A secondary window, 'Simple Display', is overlaid, showing a more detailed view of the station settings:

No.	Model Name	RWw Setting			LB Setting			LW Setting		
		Points	Start	End	Points	Start	End	Points	Start	End
0	Host Station				256	0000	00FF	256	0000	00FF
1	RJ71GN11-T2	16	0000	000F	256	0100	01FF	256	0100	01FF

A yellow callout box points to the LB and LW settings in the 'Simple Display' window, stating: "In this scenario, link devices (LB/LW) are set 256 points for each station."

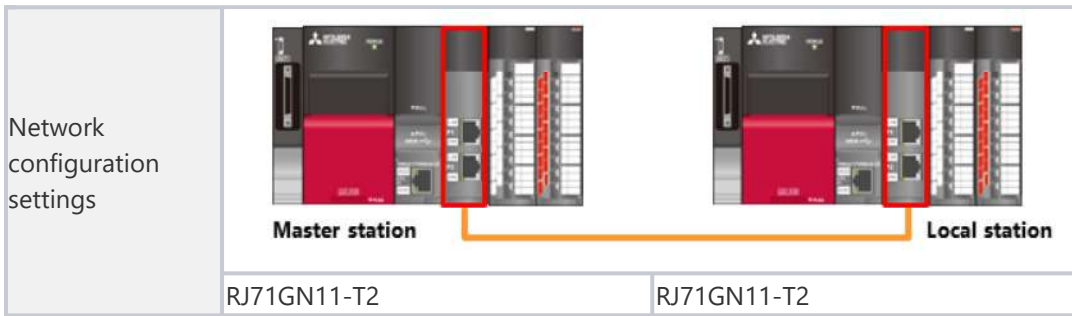

5.5.3

Refresh settings

CPU module devices and link devices must be assigned to determine the ranges used for data transfer during link refresh. The following figure shows the assignment ranges of each station link device using cyclic transmission diagram described in Chapter 5.2.

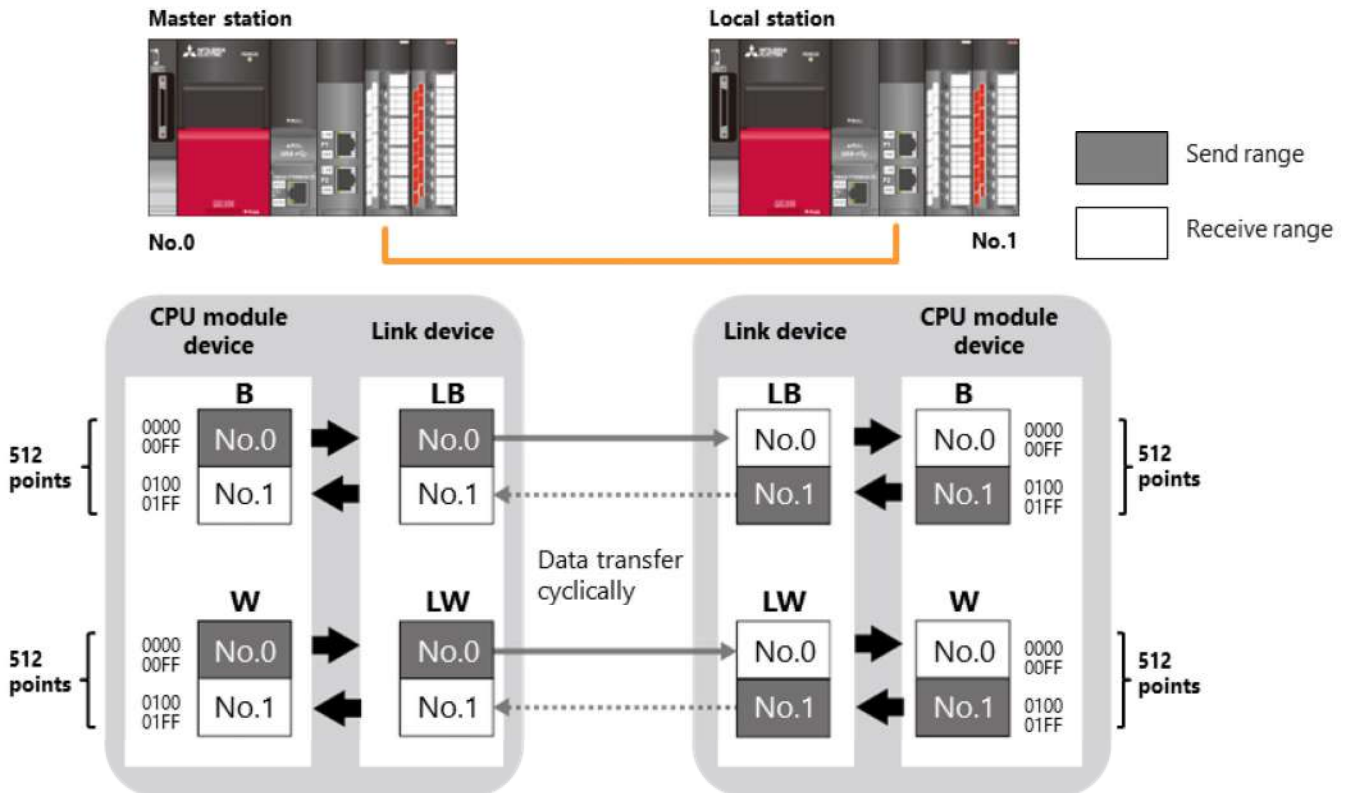

-	RJ71GN11-T2	RJ71GN11-T2
Refresh settings	CPU module device B: 512 points 0000 to 01FF W: 512 points 0000 to 01FF	Link device LB: 512 points 0000 to 01FF LW: 512 points 0000 to 01FF

On the setting window, select [Module Parameter], then [Basic Settings], then [Refresh Setting], and then [Detailed Setting] to open the refresh setting window. Input the range used for each link device. Set the same settings each to the master station and local stations.

Link Side				CPU Side				
Device Name	Points	Start	End	Target	Device Name	Points	Start	End
SB	4096	00000	00FFF	Module Label				
SW	4096	00000	00FFF	Module Label				
LB	512	00000	001FF	Specify Device	B	512	00000	001FF
LW	512	00000	001FF	Specify Device	W	512	00000	001FF

Select the link devices of the CPU module.
Link device information of the network module is transferred.

Select the link devices of the network module.

Set the range for each link device of CPU module.

Set the range for each link devices of the network module.
In this scenario, the total number of the link devices used in the master station and local stations are 512 points.

-	RJ71GN11-T2	RJ71GN11-T2
Refresh settings	CPU module device B: 512 points 0000 to 01FF W: 512 points 0000 to 01FF	Link device LB: 512 points 0000 to 01FF LW: 512 points 0000 to 01FF

Module parameter settings are completed.

*Make sure to write parameters to the CPU module after the settings are completed.

When the network operates normally, the data link LEDs on the front of modules are on.

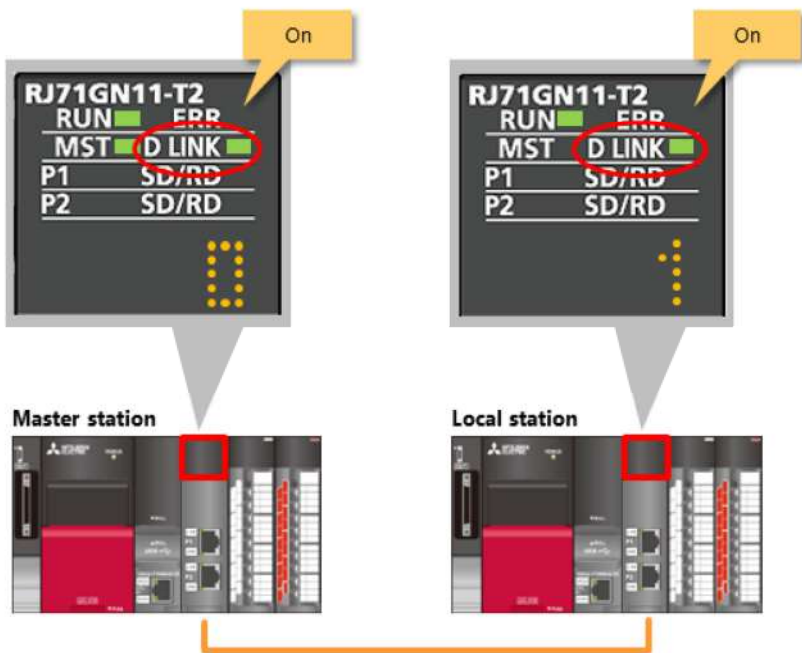

If not, check the network status using the network diagnostics.
For details on network diagnostics, refer to Section 4.8.

This section describes programs for communications between controllers.
Check the operation with turning on a **switch**.

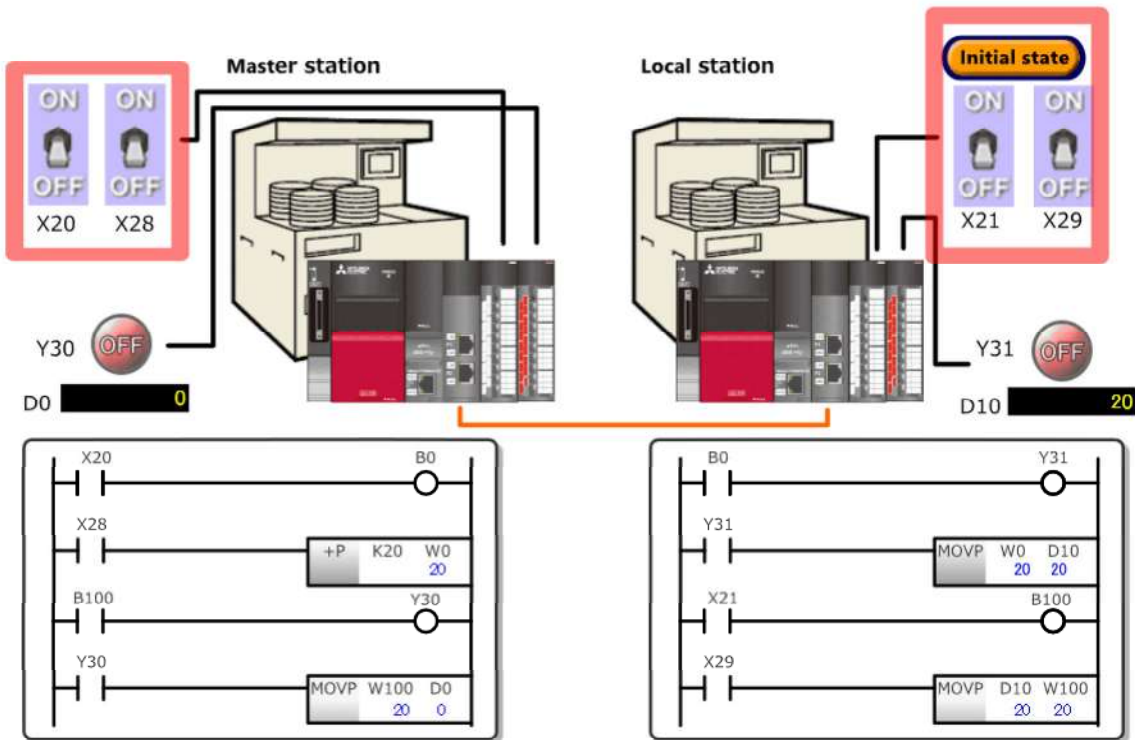

1. When a switch X28 at the master station is turned on, 20 is added to W0 every time. The value for W0 of the local station is also changed to the same value.
2. When a switch X20 at the master station is turned on or off, coil B0 at the master station and the contact B0 at the local station is on or off simultaneously.
3. Turning on or off B0 of a local station, the coil Y31 is on or off. When Y31 is on, the value of W0 is transferred to D10.
4. Turning on or off a switch X29 at the local station, the value D10 above is transferred to W100.
5. When a switch X21 at the local station is turned on or off, coil B100 at the local station and the contact B100 at the master station is on or off simultaneously. Turning on or off the contact B100 at the master station, the coil Y30 is also on or off.
6. When Y30 at the master station is turned on, the value of W100 is transferred to D0.

The contents of this chapter are:

- Procedures and settings for system start-up of the master station and local stations

Important points to consider:

Link device

- Link devices (LB and LW) for exchanging information perform input and output with one device.
- Link devices (RX, RY, RWr, and RWw) for using remote I/O switch input and output between the CPU module and remote I/O.

Select the correct description about features of FA network.

Q1

- Since information is updated instantly, devices of the station which is located away from users can be operated remotely.
- A large amount of information is exchanged between a personal computer and a programmable controller as required.

Select the purpose for using remote I/O.

Q1

- Same information is exchanged among the multiple programmable controller CPUs.
- I/O is arranged away from the controllers with the minimum wiring.

Select the correct description about the following transmission system.

Q1 Cyclic transmission

Q2 Transient transmission

Q1

Communications by the setting cyclically



Q2

Communications by a program every time



Select the correct description about a link device.

Q1

- Devices only for the network module**
- The number of usable modules are increased/decreased according to the number of modules installed on the base unit.**

Select the correct description about the advantage of integrated one network for FA networks. (Multiple choice)

Q1



The time to check an error cause is shortened.



Since communications can be performed with parameter settings only, programmers concentrate on the device settings for each station.



The time to wire cables or update systems is shortened.

Select the correct description about punctuality of FA networks.

Q1

- If communication volume is increased, communications cannot be performed or retransmission occurs.
- The latest data can be acquired surely within the specified time.

Select the correct description about features of the following network topology.

Q1 Line topology

Q2 Star topology

Q3 Ring topology

Q1

Minimum wiring

Q2

Highly scalable

Q3

Highly reliable

Select the correct description about connection ports on the CC-Link IE TSN module.

Q1

- The network modules operate in the same manner regardless of either port which is used for cable connections.**
- Network modules operate in the different manner depending on which port is used for cable connections.**

Select the correct description about the purpose for setting IP addresses.

Q1

- Set the unique number for each IP address so that the communication destination is distinguishable.
- Set the role of stations.

Select the correct description about link devices (RX and RY) assigned to the CPU module.

Q1

- No error occurs even if the link devices assigned arbitrarily.
- Set different link devices from actual devices which have already used.

Select the correct description about CC-Link IE TSN diagnostics.

Q1

- The recovery time can be shortened because the error location can be identified visually.
- The module profile must be registered to perform the network diagnostics.

You have completed the Final Test. Your results area as follows.
 To end the Final Test, proceed to the next page

	1	2	3	4	5	6	7	8	9	10
Final Test 1	✓									
Final Test 2	✓									
Final Test 3	✓	✓								
Final Test 4	✓									
Final Test 5	✓									
Final Test 6	✓									
Final Test 7	✓	✓	✓							
Final Test 8	✓									
Final Test 9	✓									
Final Test 10	✓									
Final Test 11	✓									

Total questions: **14**
 Correct answers: **14**
 Percentage: **100 %**

Clear

You have completed the PLC CC-Link IE TSN Course.

Thank you for taking this course.

We hope you enjoyed the lessons and the information you acquired in this course is useful for configuring systems in the future.

You can review the course as many times as you want.

Review

Close