

Chapter 8:

The pneumatic cylinder – part 2



Right of authorship: the content of the training (wording, drawings, pictures) are owned by the author. Any utilization except for individual use is allowed only after permission of the author.

In chapter 7 we looked at the most important features and characteristics of a pneumatic cylinder:

1. Design
2. Diameter and stroke
3. Movement
4. Number of positions
5. ISO symbols

In this chapter we will cover:

6. Cushioning
7. Detection of cylinder position (magnetic)
8. Speed control
9. International Standards

6. Cushioning

Compressed air can enter the cylinder at a very high speed. If the piston hits the cap or head at high speed, it can lead to damage. In order to avoid that, most cylinders are equipped with end-of-stroke absorbers / cushioning's, which reduce the piston's speed shortly before it reaches the cap and thus reduce shock.

There are two ways to reduce the shock:

- flexible shock absorbers
- adjustable cushioning

Chapter 8:

The pneumatic cylinder – part 2

Flexible Shock Absorbers

The easiest way to avoid a hard shock is to assemble some kind of soft material between the piston and the cap/head. It comes in form of a ring which is usually made from polyurethane and thus offers very good shock-absorption. This design is often times used for cylinders with rather small diameters where the strain is not that high. The same kind is used for compact cylinders where the small dimensions do not allow any larger devices. The flexible shock absorbers are highlighted with red arrows in the graph below.

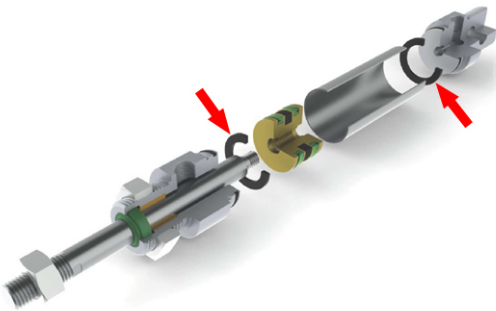

Adjustable (pneumatic) Cushioning

The adjustable pneumatic cushioning is used if it comes to stronger forces due to higher speeds or bigger sizes.

This way of reducing shock is efficient as well as wear-free. During the last 10 to 50 mm of its travel (depending on the size of the cylinder), the piston builds an air cushion inside the cylinder. The degree of cushioning (= speed reduction) can be adjusted at both ends of the cylinder for both sides respectively. The mechanism is a flow-regulating valve.

Both tie-rod and profile cylinders offer that feature, according to ISO 15552. Rodless cylinders often offer it, too. Round cylinders (ISO 6432) of larger diameters, as well as special cylinders, can be equipped accordingly.

The components of the cushioning are marked with red in the graph below.

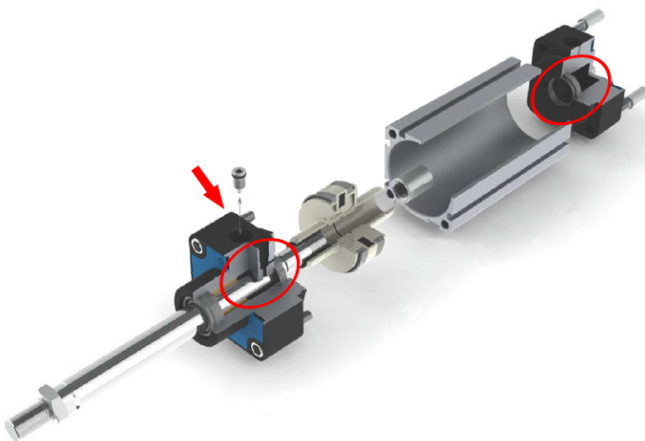

Chapter 8:

The pneumatic cylinder – part 2

Below you can learn more about **the function of the adjustable pneumatic cushioning:**

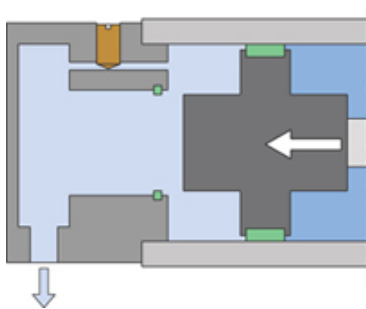

graph 1.

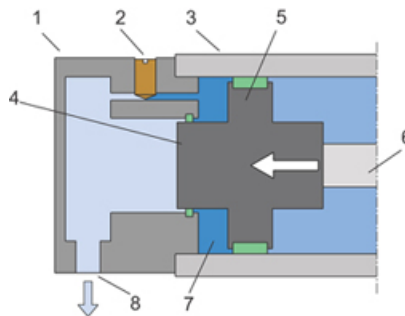

graph 2.

1. cylinder head
2. throttle screw
3. cylinder tube
4. brake piston
5. cylinder piston
6. piston rod
7. braking chamber
8. port / air connection

During the movement of the piston, the compressed air exhausts through the port (8) (graph 1).

Before the piston reaches the head, the brake piston (4) – which is part of the cylinder piston (5) – prevents the air within the braking chamber (7) from exhausting through the port (8) (graph 2). The air trapped there can only exhaust through a much smaller orifice. The orifice can be adjusted with the throttle screw.

Inside the **braking chamber** (7) pressure goes up and generates a temporary air spring. Its resistance remains there until the air has completely exhausted through the throttle screw (2).

CAUTION! The throttle screw can only adjust the degree of cushioning / speed of the cylinder piston for the last 10 to 50 mm of its movement.

How to adjust the speed of a cylinder in general will be covered later in this chapter.

Chapter 8:

The pneumatic cylinder – part 2

7. Detection of cylinder position (magnetic)

Sensors are absolutely necessary elements when it comes to industrial automation. Sensors generate information and control entire processes.

In order to detect the position of the piston, **sensors** which are triggered by a magnetic field are assembled onto the pneumatic cylinder. The **cylinder piston** is **equipped with a magnet** so that the sensor can receive a signal.

The sensor is assembled onto the cylinder in the position where the signal is required.



Many cylinders have an outer profile that offers space for assembling the sensor directly.

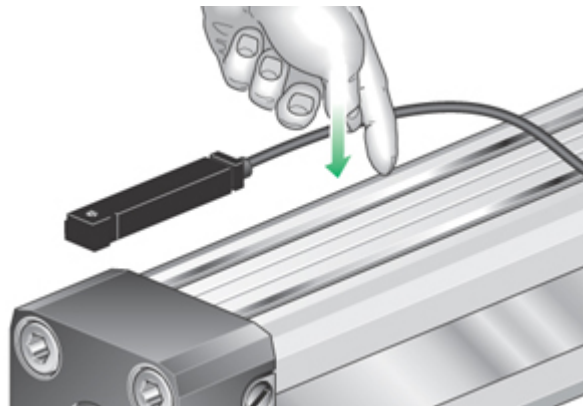

Sensor / switch ...

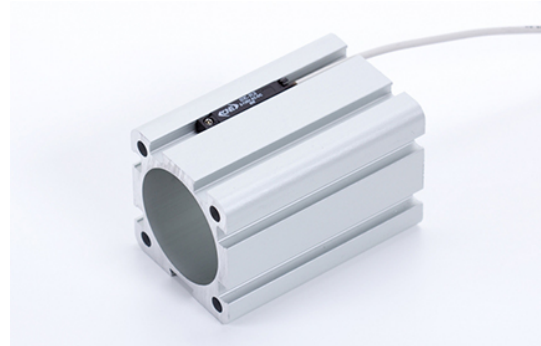

... assembled onto the tube

There are two different types of sensors / switches:

- **REED** switch
- **Inductive, PNP** switch

Chapter 8:

The pneumatic cylinder – part 2



REED switch

REED switches consist of two ferromagnetic nickel-iron wires. They are packed together in a glass tube filled with a noble gas and are made from a magnetic material.

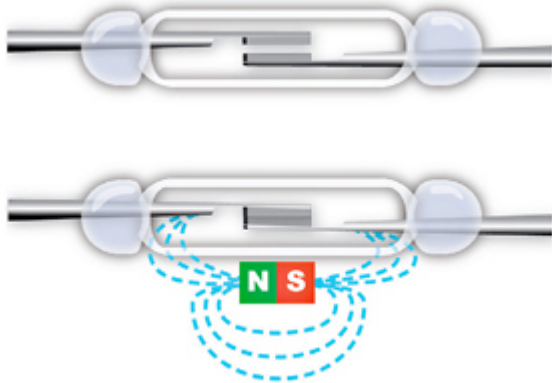

The magnet in the piston induces a magnetic field, making the shifting wires approach each other.

The shifting wires connect and close the electric circuit.

The switches have an LED that starts to glow when the circuit is closed.

The REED switches have 2 wires, which can be operated between 3 and 230 Volt AC/DC.

Symbol

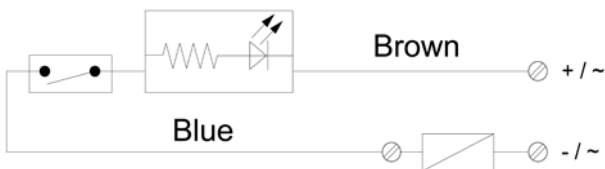

Chapter 8:

The pneumatic cylinder – part 2



Inductive, PNP switch

The function of the inductive PNP switch is based on the principles of a bipolar junction transistor. When the magnet that is built into the piston gets close to the switch, it gives a well-defined signal. The switch can be used 'normally open' as well as 'normally closed'.

An LED displays the condition of the switch.

PNP switches have generally 3 wires. They work within a voltage range of 5 to 30 V DC.

Symbol

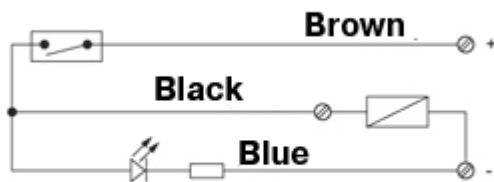

Advantages of the PNP switch in comparison to the REED switch:

- No movable parts inside
- Higher frequency
- Higher durability

Chapter 8:

The pneumatic cylinder – part 2

8. Speed control of cylinders

To control the speed of a pneumatic cylinder (actuator) over the entire stroke, flow regulators or flow-regulating silencers can be used.

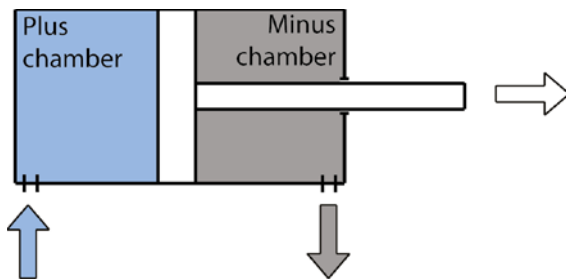

For the positive movement of a double-acting cylinder, compressed air enters the plus chamber. Simultaneously, the air in the minus chamber exits. (controlled by a 5/2-way valve)

Ideally, we control the speed of the cylinder by reducing the flow of the exiting air.

To control the speed, we regulate the exhaust air flowing out of the cylinder chamber. We thereby avoid an immediate exhaust. The air in both chambers is available as long as the piston has reached the end position. The movement is therefore very smooth.

CAUTION! In order to set the speed of the cylinder and to get a smooth movement, it is always the **exhaust air** that has to be controlled.

To do this there are different products available for speed regulation:

- Uni-directional flow regulator – block form flow regulator
- Uni-directional flow regulator – function fitting to be assembled in the cylinder
- Uni-directional flow regulator – function fitting to be assembled in the valve
- Exhaust flow regulator – to be assembled into the valve

Chapter 8:

The pneumatic cylinder – part 2

Uni-directional flow regulator = one-way flow control valve

In order to allow compressed air to flow into the cylinder at full speed, while allowing it to exhaust slowly, we use a **one-way flow control valve**.



Throttled air-flow:

Air flowing this way has to pass the throttle (flow regulator) as the other path is blocked by a check valve.

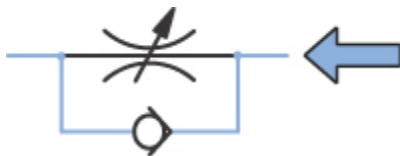

Free air-flow:

Air flowing the opposite direction can bypass the throttle and passes through the check-valve (non-return valve).

By using two one-way flow control valves, we can independently regulate the positive as well as the negative movement of the cylinder.

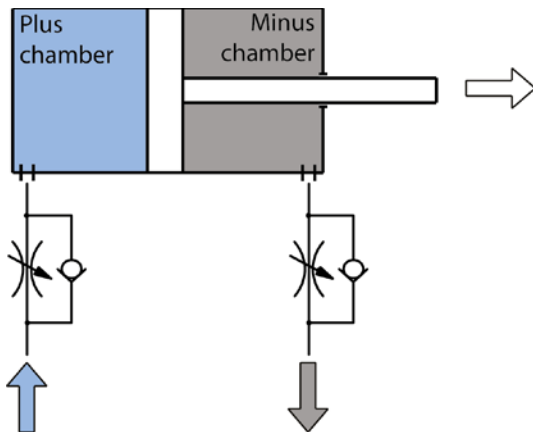

During **positive movement**, air bypasses the flow regulator into the plus chamber. Air that is supposed to leave the minus chamber has to pass through the throttle in the flow regulator. This limits the speed of the cylinder.

During **negative movement**, the air flows through the same block form flow regulators. This time the air flowing into the minus chamber bypasses the throttle while the exhaust of the plus chamber is regulated.

The speed of the positive movement has to be adjusted at the regulator of the minus chamber and vice versa.

There are many different designs of flow-regulators available and their sizes differ depending on the manufacturer.

Chapter 8:

The pneumatic cylinder – part 2



Function fittings are screwed either directly into the cylinder or into the valve. Therefore there are two different types, one for each area of application.

- A flow regulator **for a cylinder** reduces the flow that streams from the thread to the push-in fitting (out of the cylinder).
- A flow regulator **for a valve** regulates the flow from the push-in fitting to the threaded port (into the valve).

There are products where the manual adjustment can be done with a screw-driver or with a knurled-head screw.

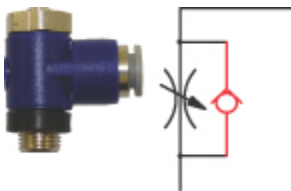

Function fitting with one-way flow regulator for cylinder

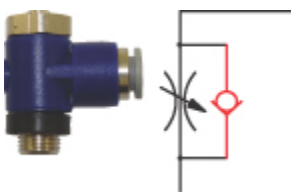

Function fitting with one-way flow regulator for valve

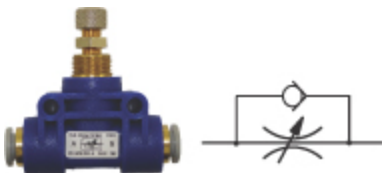

One-way flow regulator with two push-in fittings

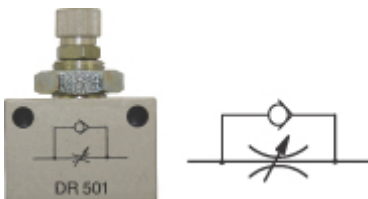

Block form flow regulator with two female ports

Chapter 8:

The pneumatic cylinder – part 2

Sample circuits for cylinders with speed control

Below you see three different ways of speed control for a double-acting cylinder, with air supply via a joint FRL.

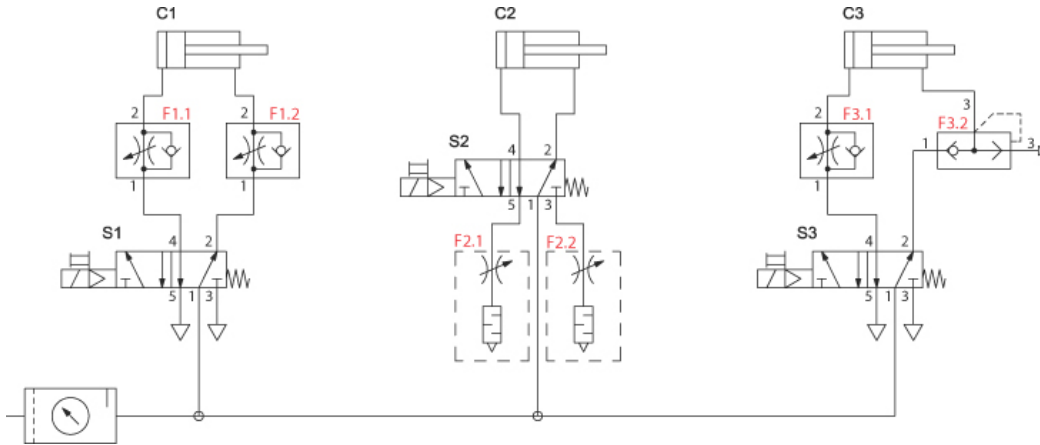

Circuit 1 (Cylinder C1):

The double-acting cylinder C1 is controlled by the single solenoid 5/2-way valve S1. As soon as the valve is actuated, air flows into the Plus chamber of the cylinder via F1.1. The air flow is not restricted by F1.1. Simultaneously, air needs to exhaust from the Minus chamber of the cylinder via F1.2. This flow is restricted by F1.2. Via the directional valve S1 (port 3), the air is finally exhausted. As soon as the electric actuation of the directional valve S1 is taken away, the valve switches back to normal position. Air flows at full speed via F1.2 into the Minus chamber of cylinder C1, while the air in the Plus chamber exits via F1.1 and S1, exhausting at port 5 of S1. This flow is restricted by / adjusted at F1.1. The positive movement of the cylinder is regulated at F1.2, the negative movement is restricted at F1.1. F1.1. and F1.2. can be screwed either into the cylinder or the valve, but the correct version has to be selected either way!

Circuit 2 (Cylinder C2):

The double-acting cylinder C2 is controlled by the single solenoid 5/2-way valve S2. The speed of the cylinder is adjusted at flow control silencers F2.1 and F2.2., which are screwed into the valve. For positive movement, the directional valve S2 needs to be actuated. Air streams at full speed from port 1 to port 4 of the valve and into the Plus chamber of cylinder C2. At the same time air needs to exhaust from the Minus chamber of the cylinder. The air streams into port 2 of the valve S2. Its flow is restricted by F2.2 before leaving the valve S2 at port 3. For negative movement, the valve switches back into standard position. The Minus chamber is supplied via port 2 of valve S2. The exhaust from the Plus chamber is restricted by F2.1 in port 5 of the valve S2.

Circuit 3 (Cylinder C3):

The double-acting cylinder C3 is controlled by the single solenoid 5/2-way valve S3. For an extremely quick positive movement after actuating the valve, the Minus chamber is exhausted by the quick exhaust valve F3.2.; the exhaust air does not pass the directional control valve S3. For negative movement, the valve S3 needs to switch back into normal position. The exhaust air of the Plus chamber has to go through the one-way flow regulator F3.1

Chapter 8:

The pneumatic cylinder – part 2

9. International Standards

The most common cylinders in pneumatics have been standardized, the target being maximum compatibility between products of different manufacturers.

The most common cylinder standards are:

- **ISO 15552** | **VDMA 24562** | **DIN ISO 6431** (old standard) | for profile and tie-rod cylinders.

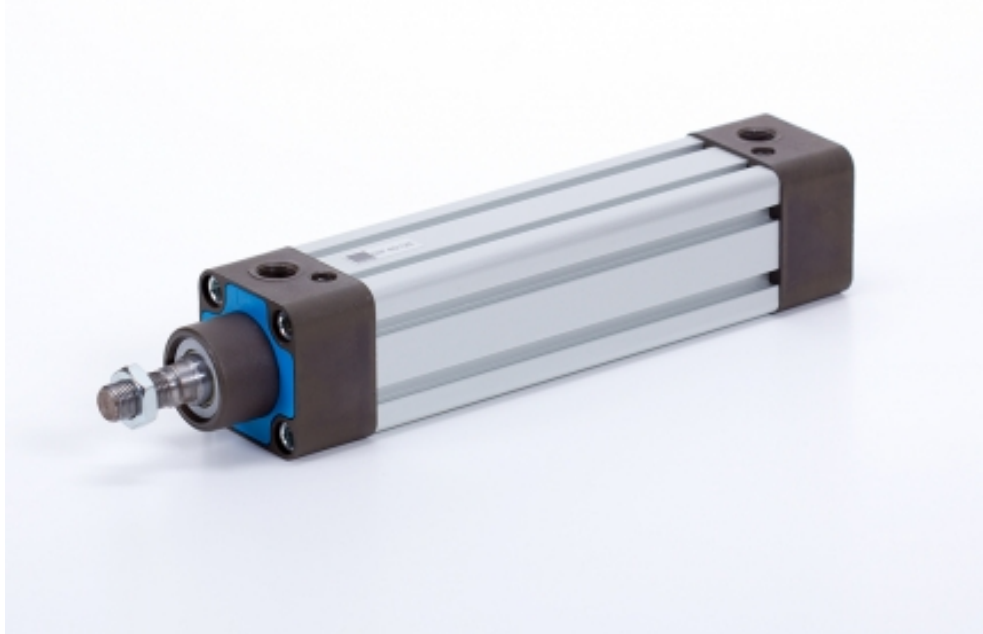

Chapter 8:

The pneumatic cylinder – part 2

- **DIN ISO 6432** | round cylinders



Chapter 8:

The pneumatic cylinder – part 2

- **ISO 21287** | compact cylinders



Chapter 8:

The pneumatic cylinder – part 2

- **UNITOP** | compact cylinders



Chapter 8:

The pneumatic cylinder – part 2



The HAFNER ISO 15552 cylinders

The standard **ISO 15552** is valid since 2004. The previous and very closely related standard was **ISO 6431** (1992 - 2004).

The standard defines piston diameters ($\varnothing 32 \dots \varnothing 320$ mm), maximum pressure (10 bar), and distinct features and dimensions, as well as standard accessories.

Thus any **accessories** are also **mostly interchangeable**.

The ISO 15552 cylinders in the HAFNER range have the type number **DIL** and **DIP** (for products with a run-through piston rod: **DBL** and **DBP**)



DIL cylinder

The more economic solution since little material is used for the profile. Easy to clean. Any sensors have to be assembled with special fixing elements.



DIP cylinder

Switches can go into the groove, easy assembly, no additional parts.

Since 2016 HAFNER have been offering another range of economically-priced profile cylinders called "**H-series**".

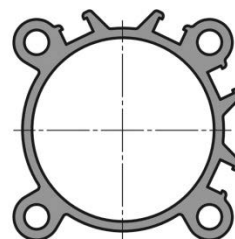

HIF cylinder

Switches can go into one of the four grooves of the profile tube.

Chapter 8:

The pneumatic cylinder – part 2

Materials used in an ISO 15552 cylinder of the D-series:

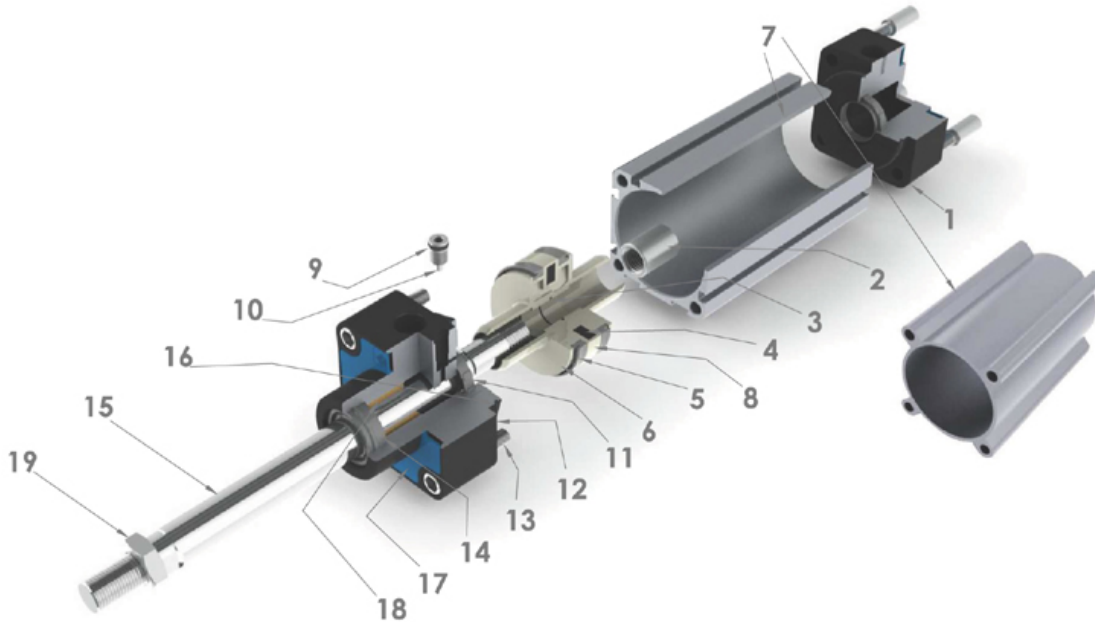

#	Description	Material
1.	Cylinder cap	Aluminum, anodized
2.	Fixing nut for piston	Steel, nickel plated
3.	O-Ring (seal between piston and piston rod)	NBR
4.	Magnet	Ferromagnetic material
5.	Piston seal	Polyurethane
6.	Piston	Techn. polymer (or aluminum)
7.	Tube	Aluminum, anodized
8.	Guide	Techn. polymer
9.	O-Ring (seal for cushioning)	NBR
10.	Screw (for cushioning)	Steel, nickel plated
11.	Mobile seal (for cushioning)	Polyurethane
12.	Cylinder head	Aluminum, anodized
13.	Screws	Steel, nickel plated
14.	Seal for piston rod	Polyurethane
15.	Piston rod	Chromed steel or stainless steel
16.	O-Ring (seal between head and tube / cap and	NBR
17.	Covers	PA
18.	Bushing / bearing for piston rod	Sintered bronze
19.	Nut at piston rod	Steel, nickel plated

Chapter 8:

The pneumatic cylinder – part 2



Due to high speeds, long strokes and high frequencies the seals can wear out faster than other parts. Therefore we offer spare-part kits for the cylinders. The spare-part kits contain all potentially worn-out parts.

Repair kits for cylinders types DIL, DIP, DBL and DBP have the order code **DIR**.

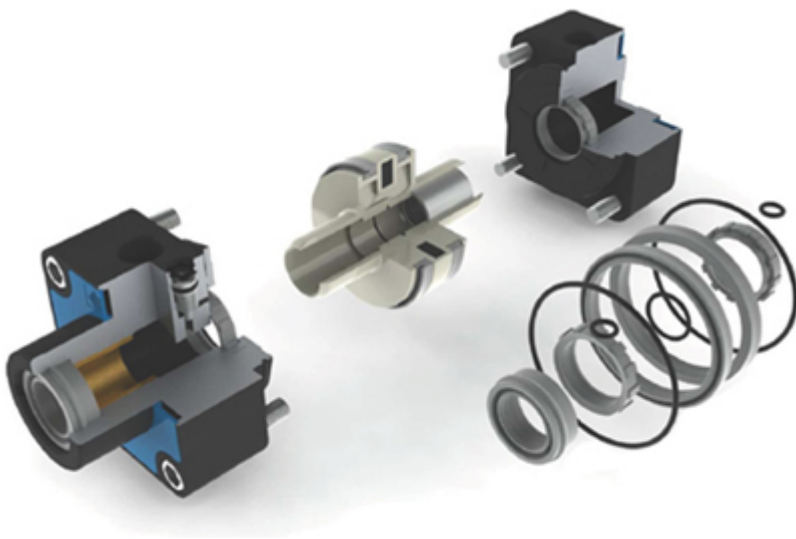

Standard ISO 15552 also defines the dimensions of the **fixed accessories**. Therefore any accessories by different manufacturers will be mostly compatible.

